

SAMS
PUBLISHING

TOM SWAN



**Disk includes all
the source code
from the book!**

Explore data structures, input and output, macros and conditional assembly, disk-file processing, and interrupt handling

Find out how to write inline assembler code with Turbo C and Turbo Pascal

Master the new features of the latest version of Borland Turbo Assembler

Mastering
TURBO ASSEMBLER[®]
SECOND EDITION

**Mastering
Turbo Assembler[®]
Second Edition**

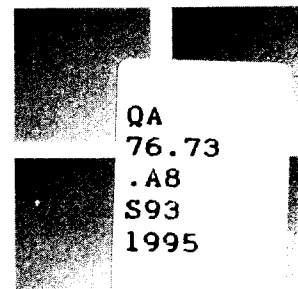
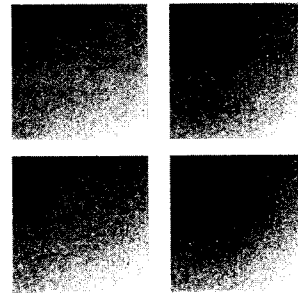

Tom Swan

SAMS
PUBLISHING

201 West 103rd Street
Indianapolis, Indiana 46290

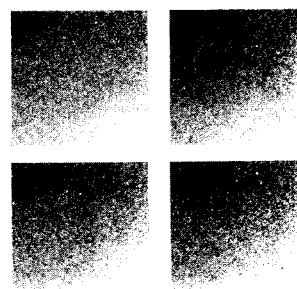



To Richard Day.

Copyright © 1995 by Tom Swan

SECOND EDITION

All rights reserved. No part of this book shall be reproduced, stored in a retrieval system, or transmitted by any means, electronic, mechanical, photocopying, recording, or otherwise, without written permission from the publisher. No patent liability is assumed with respect to the use of the information contained herein. Although every precaution has been taken in the preparation of this book, the publisher and author assume no responsibility for errors or omissions. Neither is any liability assumed for damages resulting from the use of the information contained herein. For information, address Sams Publishing, 201 W. 103rd St., Indianapolis, IN 46290.

International Standard Book Number: 0-672-30526-7

Library of Congress Catalog Card Number: 94-66280

98 97 4 3 2

Interpretation of the printing code: the rightmost double-digit number is the year of the book's printing; the rightmost single-digit, the number of the book's printing. For example, a printing code of 95-1 shows that the first printing of the book occurred in 1995.

Composed in AGaramond MCPdigital by Macmillan Computer Publishing

Printed in the United States of America

Trademarks

All terms mentioned in this book that are known to be trademarks or service marks have been appropriately capitalized. Sams Publishing cannot attest to the accuracy of this information. Use of a term in this book should not be regarded as affecting the validity of any trademark or service mark. Turbo Assembler is a registered trademark of Borland International.

Publisher
Richard K. Swadley

Acquisitions Manager
Greg Wiegand

Managing Editor
Cindy Morrow

Acquisitions Editor
Chris Denny

Development and Production Editor
Fran Hatton

Software Development Specialist
Steve Flatt

Editorial Coordinator
Bill Whitmer

Editorial Assistants
Carol Ackerman
Sharon Cox
Lynette Quinn

Technical Reviewer
Greg Guntle

Marketing Manager
Gregg Bushyeager

Assistant Marketing Manager
Michelle Milner

Cover Designer
Tim Amrhein

Book Designer
Alyssa Yesh

Vice President of Manufacturing and Production
Jeff Valler

Manufacturing Coordinator
Paul Gilchrist

Imprint Manager
Kelly Dobbs

Team Supervisor
Katy Bodenmiller

Support Services Manager
Juli Cook

Support Services Supervisor
Mary Beth Wakefield

Production Analysts
Angela Bannan
Dennis Clay Hager
Bobbi Satterfield

Graphics Image Specialists
Becky Beheler
Steve Carlin
Brad Dixon
Teresa Forrester
Jason Hand
Clint Lahmen
Cheri Laughner
Mike Reynolds
Laura Robbins
Dennis Sheehan
Craig Small
Jeff Yesh

Production
Mona Brown
Michael Brumitt
Jama Carter
Charlotte Clapp
Mary Ann Cosby
Judy Everly
Donna Harbin
Michael Henry
Aleata Howard
Louisa Klucznik
Ayanna Lacey
Kevin Laseau
Shawn MacDonald
Donna Martin
Casey Price
Brian-Kent Proffitt
Erich Richter
SASpringer
Jill Thompson
Tina Trettin
Mark Walche
Dennis Wesner
Michelle Worthington

Indexer
Bront Davis

Overview

Part I	Programming with Assembly Language	1
1	Introduction	3
2	First Steps	19
3	A Bit of Binary	53
4	Programming in Assembly Language	73
5	Simple Data Structures	143
6	Complex Data Structures	197
7	Input and Output	247
8	Macros and Conditional Assembly	299
9	Disk-File Processing	337
10	Interrupt Handling	369
11	Advanced Topics	423
Part II	Application Programming	491
12	Mixing Assembly Language with Pascal	493
13	Mixing Assembly Language with C and C++	531
14	Programming with Objects	583
15	Programming for Windows	653
Part III	Reference	701

16	Assembly Language Reference Guide	703
17	Turbo Assembler Reference	787
A	Assembling the Disk Files	817
B	File Directory	825
C	Answers to Exercises	829
	Bibliography	867
	Index	871

Contents

Part I	Programming with Assembly Language	1
1	Introduction	3
	Learning Assembly Language	4
	You Take the High Level and I'll Take the Low Level.....	4
	Developing Mental Pictures	5
	Preventive Debugging	6
	Striving for the Ideal	7
	Advantages of Assembly Language	7
	Disadvantages of Assembly Language	8
	Hardware Requirements	9
	Software Requirements	10
	Microsoft Windows Users	11
	How To Use This Book	11
	About the Chapters	11
	About the Modules	13
	How To Organize Your Disks	13
	Hard Drives	13
	Floppy Disk Drives	14
	Older Turbo Assembler Versions	15
	Entering Program Listings	15
	Getting More Help	16
	Summary	16
	Exercises	17
2	First Steps	19
	Assembly Language: Parts and Pieces	20
	The Header	20
	Equates	23
	The Data Segment	24
	Reserving Space for Variables	25
	The Program Body	27

A Few Comments on Comments	29
The Closing	30
Assembling a Program	30
Understanding Object Code	32
Command-Line Options	33
Dealing with Errors	34
Introducing Turbo Debugger	37
Debugging with an 80386 or Later Processor	37
Turbo Debugger as Teacher	38
Writing .COM and .EXE Programs	42
Writing .COM Programs	44
Assembling .COM Programs	45
It Ain't Over Till ... Actually, It Ain't Ever Over	45
Writing .EXE Programs	46
Printing Listings	46
Listing PR132	48
Summary	49
Exercises	50
Projects	51
3 A Bit of Binary	53
Memorabilia	54
How Many Bits in a Byte?	55
Binary Arithmetic and Logic	56
Counting in Binary	56
The Power of 2	58
Finite Values	58
The K Game	59
Binary and Hexadecimal	59
Converting Hexadecimal and Decimal Values	60
Two's Complement Notation	61
Subtracting by Adding	64

Logical Operators	65
Masking with AND	65
Setting Bits with OR.....	66
The Exclusive OR Club	67
Shifting and Rotating.....	69
Summary	70
Exercises	71
Projects	72
4 Programming in Assembly Language	73
Memory Segmentation	74
Paragraphs, Segments, and Offsets	75
8086 Registers	76
General-Purpose Registers.....	77
Pointer and Index Registers.....	77
Segment Registers	78
Instruction Pointer.....	79
Flags	79
Instruction Groups and Concepts	80
Data Transfer Instructions	80
A Moving Example	82
Running MOV in Turbo Debugger.....	83
Stacking the Deck	84
How Stacks Operate	85
A Stack Demo.....	86
Running the PUSHPOP Demo	87
Stack Management	88
Exchanging Data	89
Arithmetic Instructions	90
Addition Instructions.....	92
Subtraction Instructions.....	93
Add and Subtract Demonstration	94
Running the ADDSUB Demo	95
Watching Out for Number One	96
Sneaky Subtractions	97

Multiplying and Dividing Unsigned Values	97
Running the MULDIV Demo	98
Multiplying and Dividing Signed Values	100
Converting Bytes, Words, and Doublewords	100
Logic Instructions	101
Logical Combinations	102
Running the ANDORXOR Demo	103
Testing 0001 0010 0011	103
Shifting Bits Around	104
Running the SHIFT Demo	106
Why Shift?	109
Shifty Multiplies and Divides	110
Flow-Control Instructions	110
Unconditional Transfers	112
Calling Subroutines	112
Running the SUBDEMO Program	114
The Long and Short of It	116
Passing Values to and from Subroutines	117
To Push or Not to Push	118
Jumping Unconditionally	119
Jumping Conditionally	120
Double Jumping	122
Using Conditional Jumps	123
Conditional Restrictions	124
Learning More About Conditional Jumps	125
Processor Control Instructions	126
Flag Operations	127
Getting in Synch	128
Something for Nothing	128
Saving Jump Space	129
Using the JUMPS Directive	130
String Instructions	131
String Index Registers	132
Loading Strings	133

	Using Shorthand String Mnemonics	134
	Addressing String Labels	135
	Storing Data to Strings	135
	Moving Strings	136
	Filling Memory	136
	Scanning Strings	137
	When Zero Means Zero	138
	Comparing Strings	138
	Summary	139
	Exercises	140
	Projects	141
5	Simple Data Structures	143
	Addressing Data in Memory	144
	Memory-Addressing Modes	145
	Direct Addresses	146
	Overrides	146
	Register-Indirect Addresses	147
	Base Addresses	148
	Indexed Addresses	149
	Base-Indexed Addresses	149
	Using the ASSUME Directive	150
	Expressions and Operators	152
	Simple Variables	152
	Wide Open Spaces	153
	Initialized Versus Uninitialized Data	155
	String Variables	157
	Quoting Quotes	158
	Local Labels	159
	An ASCIIZ String Package	160
	Programming in Pieces	170
	Public Policy	171
	Assembling and Linking Separate Modules	172

A String I/O Package	173
Procedures in STRIO	176
Using the STRIO Module	177
Linking Modules into a Program	179
New Features in ECHOSTR.ASM	180
A Simplified External Example	181
Exploring the Strings Module	182
Repeated-Loop Calculations	187
Summary	193
Exercises	194
Projects	195
6 Complex Data Structures	197
Structures	198
Declaring Structured Variables	198
A Structured Demo	199
Running the STRUC Demo	200
Using Structured Variables	202
STRIO Structures	203
More About Numeric Variables	204
Using RADIX	204
Signed and Unsigned Integers	205
Floating-Point Numbers	205
Binary-Coded Decimals	206
Arrays in Assembly Language	206
Changing Types with LABEL	208
Indexing Arrays	209
Multibyte Array Values	211
Unions and Records	213
Declaring RECORD Types	214
Setting Default Bit-Field Values	215
Using RECORD Variables	216
What's in a Field Name?	216

	Extracting Bit Fields	217
	Recombining Bit Fields.....	218
	Efficient Logical Operations	220
	Automating Efficient Logical Operations	220
	Automating Record Field Operations	221
	Using Predefined Equates	223
	Running VERSION	224
	Converting Numbers and Strings.....	225
	Using the BINASC Module	231
	Putting BINASC to Work	237
	How EQUIP Works	240
	Programming a Number Base Converter	240
	Summary	243
	Exercises	244
	Projects	245
7	Input and Output	247
	Standard Input and Output	248
	Taking a Break.....	248
	Unfiltered Input	249
	Unfiltered Output	250
	Waiting Around—and Around	251
	Key Press Checking.....	252
	Reading Function Keys	254
	Flushing the Type-Ahead Buffer	255
	Introducing DOS Handles.....	256
	Writing DOS Filters	258
	How FILTER Works	262
	Customizing FILTER	264
	Printing Text	265
	Selecting Printer Features	266
	Memory-Mapped Video	267
	Cursor Coordinates.....	269
	More About I/O Ports	272

A Memory-Mapped Video Module.....	272
A SCREEN Demonstration	279
Using the SCREEN Module	282
A Module for Keyboard Control.....	289
A KEYBOARD Demonstration	290
Using the KEYBOARD Module	292
Summary	296
Exercises	296
Projects	297
8 Macros and Conditional Assembly	299
What Are Macros?	300
Macro Advantages and Disadvantages	300
Constructing Macros	301
Purging Macro Definitions	301
Parameter Substitution	302
Symbolic Parameters	304
Numeric Parameters	305
String Parameters	306
Macros and Variables	307
Definitions that Repeat	308
Macros and Code	310
Register Preservation	311
Using the Include Directive	312
Local Labels	313
Conditional Compilation.....	314
Defining Conditional Symbols	314
Using Conditional Symbols	316
To Define or Not To Define	319
Handling Conditional Errors	319
Ending Macro Expansion	320
GOTO Directive	321
Meanwhile, Back at the Macro.....	321
Pushing and Popping the Assembler State	322

	Extracting Bit Fields	217
	Recombining Bit Fields.....	218
	Efficient Logical Operations	220
	Automating Efficient Logical Operations	220
	Automating Record Field Operations	221
	Using Predefined Equates	223
	Running VERSION	224
	Converting Numbers and Strings.....	225
	Using the BINASC Module	231
	Putting BINASC to Work	237
	How EQUIP Works	240
	Programming a Number Base Converter	240
	Summary	243
	Exercises	244
	Projects	245
7	Input and Output	247
	Standard Input and Output	248
	Taking a Break.....	248
	Unfiltered Input	249
	Unfiltered Output	250
	Waiting Around—and Around	251
	Key Press Checking.....	252
	Reading Function Keys	254
	Flushing the Type-Ahead Buffer	255
	Introducing DOS Handles.....	256
	Writing DOS Filters	258
	How FILTER Works	262
	Customizing FILTER	264
	Printing Text	265
	Selecting Printer Features	266
	Memory-Mapped Video	267
	Cursor Coordinates.....	269
	More About I/O Ports	272

A Memory-Mapped Video Module.....	272
A SCREEN Demonstration	279
Using the SCREEN Module	282
A Module for Keyboard Control	289
A KEYBOARD Demonstration	290
Using the KEYBOARD Module	292
Summary	296
Exercises	296
Projects	297
8 Macros and Conditional Assembly	299
What Are Macros?	300
Macro Advantages and Disadvantages	300
Constructing Macros	301
Purging Macro Definitions	301
Parameter Substitution	302
Symbolic Parameters	304
Numeric Parameters	305
String Parameters	306
Macros and Variables	307
Definitions that Repeat	308
Macros and Code	310
Register Preservation	311
Using the Include Directive	312
Local Labels	313
Conditional Compilation.....	314
Defining Conditional Symbols	314
Using Conditional Symbols	316
To Define or Not To Define	319
Handling Conditional Errors	319
Ending Macro Expansion	320
GOTO Directive	321
Meanwhile, Back at the Macro.....	321
Pushing and Popping the Assembler State	322

	Starting a DOS Macro Library	324
	Using DOSMACS.ASM	331
	Summary	333
	Exercises	334
	Projects	335
9	Disk-File Processing	337
	Getting a Handle on Files	338
	Disk-File Concepts	338
	Maximum Files	339
	Opening and Closing Files	339
	Flushing File Buffers	340
	Closing Files	341
	Dealing with Disk Errors	341
	Using DiskErr	344
	How DiskErr Works	344
	Creating New Files	345
	Reading the DOS Command Line	346
	Running a PARAMS Demonstration	349
	Using PARAMS	351
	How PARAMS Works	352
	Reading and Writing Text Files	354
	How KOPY.ASM Works	358
	Reading and Writing Data Files	359
	Reading the Disk Directory	361
	How DR Works	364
	Summary	366
	Exercises	367
	Projects	367
10	Interrupt Handling	369
	We Interrupt This Program...	370
	Writing Interrupt Service Routines	370
	Maskable Versus Nonmaskable Interrupts	371
	Interrupt Vectors and the 8259 Chip	372

Why hlt Doesn't Halt	376
Servicing Interrupts	377
Tapping into the PC Timer Interrupt	380
Timer Tick Tricks	381
Interrupts and Variables	381
Interrupting ISRs	382
The End-of-Interrupt Command	384
Interrupts and Stacks	385
Using int and into Instructions	388
Trapping Divide-Fault Interrupts	389
Fixing a Divide Fault	389
Installing a Divide-Fault Handler	390
Testing DIV286	393
How DIV286 Works	394
Installing TSR Code in Memory	395
Interrupt-Driven Serial Communications	397
Running an ASYNCH Demonstration	405
How TRM Works	408
How To Use the ASYNCH Package	409
Debugging with Interrupts	414
Single Stepping	414
Setting and Clearing tf	415
How SINGLE Works	419
Summary	421
Exercises	422
Projects	422
11 Advanced Topics	423
Advancing Your Assembly Language Knowledge	424
Binary Coded Decimals	424
BCDs in Memory	425
Unpacked BCD Instructions	426
Converting Unpacked BCD and ASCII	427
Packed BCD Instructions	428

A BCD Math Package	429
Using the BCD Module.....	434
Advanced Separate Assemblies	438
Using Communal Variables	439
Using Global Variables	440
Including Global Variables	440
Using the INCLUDELIB Directive	441
Processing Tables	442
How TABLE.ASM Works	443
Practical xlat Uses	443
How BOXCHAR.ASM Works	445
Using xlat with Multiple-Dimension Tables	445
Other xlat Forms	446
Declaring Segments the Hard Way	446
The SEGMENT Directive.....	447
Using SEGMENT	450
The ASSUME Directive	451
The GROUP Directive	452
Using Segments in Programs.....	453
Using HARDSHEL.ASM	456
Where It's At	456
How COLDBOOT.ASM Works	458
Far Data Segments	458
Multiple Far Data Segments	460
Uninitialized Far Data Segments	461
Programming the 80286 and Later Processors	461
Using the bound Instruction	462
How BOUND286.ASM Works	465
Using enter and leave	466
Using pusha and popa	467
Reading and Writing Port Strings	467
Immediate Shift and Rotate Values	468

Programming the 80386	468
Starting to Program the 80386	469
Scanning and Setting Bits	470
Testing Bits	472
More Conversions	472
Other 80386 Instructions	472
Double-Precision Shifts	474
The VERSION Directive	474
Enumerated Data Types	475
Getting SMART	478
Smart Effective Addresses	478
Sign-Extended Boolean Operations	479
Call Me Smart	479
Pushy Pushy	480
Some Additional Instructions	481
Loop the Loop	481
Enter or Leave When Ready	482
Return to Sender	482
Interrupting 32-Bit Code Segments	483
More Pushy Instructions	483
Shifty Instructions	483
Fast Multiplications	484
Summary	486
Exercises	488
Projects	489
Part II Application Programming	491
12 Mixing Assembly Language with Pascal	493
Room for Improvement	494
Identifying Critical Code	495
Converting Pascal to Assembly Language	496
External Procedures and Functions	498
Calling External Routines from Pascal	498

The Pascal Memory Model	499
PASSHELL's DATA Segment	500
Using Static Variables	501
PASSHELL's CODE Segment	502
Calling Pascal Procedures	502
The Code-Segment Body	503
A (Somewhat) Crazy Example	504
Understanding PASDEMO	507
Addressing Code-Segment Data	508
Addressing Typed Constants	509
Calling Pascal Functions	509
Addressing Pascal Variables	511
Calling External Functions	511
Passing Parameters	512
Value Parameters	512
Returning from External Code	514
Variable Parameters	514
Using the TPASCAL Memory Model	515
Using the ARG Directive	516
Deallocating Stacked Parameters	516
Writing External String Functions	517
How FILLSTR Works	518
Declaring Parameters Without ARG	519
Going for Speed	520
The Pascal Program	520
Examining STRSLOW's Code	522
Optimizing STR.PAS	524
How STR.ASM Works	525
Summary	526
Exercises	527
Projects	529
13 Mixing Assembly Language with C and C++	531
Mixing C and C++ with Assembly Language	532
Identifying Critical Code	532

Using Registers	533
Inline Assemblies	533
Compiling and Assembling Inline Code	535
How To Compile TALLY.C	535
Pragmatic Assemblies	536
Locations for Data and Code Statements	537
Enabling 80286/386 Instructions	538
Sharing Data	538
Declaring Assembly Language Data	539
C Structures	540
Sharing Code	541
How UPDOWN.C Works	543
Behind the Scenes	543
External Assemblies	544
Simplified Memory Models	545
Using CSHELL.ASM	547
About Underscores	548
Using Far Data	548
Sharing Code	549
Compiling CFILLSTR.C	549
Calling Assembly Language Functions from C	550
Assembling and Linking External Modules	551
Assembling and Linking Separately	552
Easier Linking	553
Debugging Multilanguage Programs	554
How CFILLSTR.C and CFILL.ASM Work	555
Calling C Functions from Assembly Language	555
Function Results	557
LOCAL Variables	558
Calling C++ Functions from Assembly Language	560
Name Mangling	560
Calling Assembly Language Functions from C++	562
Multiple External Functions	563
Calling C++ Functions from Assembly Language	563
Mixing Global Data	564

	Passing Function Arguments	565
	Passing Arguments from C++ to Assembly Language ..	567
	Passing Arguments from Assembly Language to C++ ..	568
	Declaring Procedure Arguments Automatically	569
	Mixing C++ Classes with Assembly Language	570
	Creating the C++ Class	571
	Accessing Class Objects from Assembly Language	576
	Summary	579
	Exercises	580
	Projects	581
14	Programming with Objects	583
	Object-Oriented Programming with TASM	584
	Why Use OOP?	584
	Advantages of OOP	585
	Disadvantages of OOP	586
	OOP and Turbo Assembler	586
	OOP on Its Own Terms	587
	Fundamentals of TASM Objects	589
	Encapsulation	590
	Inheritance	602
	Virtual Methods	609
	Polymorphism	627
	Creating a List Object	627
	Using the List Object	633
	Other OOP Tips and Tidbits	645
	A Bug in the Debugger	645
	More on VMT Pointers	646
	Initializing a VMT Pointer	647
	Calling Ancestor Virtual Methods	648
	VMTs and Segment Addressing	648
	Calling Virtual Methods without CALL...METHOD	648

Optimized Tail Recursion	650
Summary	651
Exercises	651
Projects	652
15 Programming for Windows	653
Introducing Windows Programming with TASM	654
Minimum Windows Application	655
How to Assemble WHello	662
The Preface	663
External and Public Declarations	664
Data Segments	665
Startup Code	666
Initializing the Data Segment Register	668
The WinMain Function	669
Window Registration	669
Window Creation	672
The Message Loop	673
The Window Procedure	675
Linker Definition File	677
Resource Script File	678
Developing Windows Applications with TASM	679
Windows Application Shell	679
How to Assemble WinApp	692
Overview of WinApp	692
Menus	695
Dialog Boxes	696
The Dialog Procedure	697
Summary	698
Exercises	699
Projects	700

Part III	Reference	701
16	Assembly Language Reference Guide	703
	About the Reference	704
	Protected-Mode Instructions	704
	Going to the Source	704
	Instruction Timings and Binary Encodings	705
	How To Use the Reference	706
	More About the Headers	707
	More About the Syntax/Example Sections	707
	More About the Examples and Samples	709
17	Turbo Assembler Reference	787
	Symbols	788
	Operators	792
	Mode Equivalents	795
	Directives	797
A	Assembling the Disk Files	817
	Assembly Language Listings	818
	Requirements	818
	Instructions	818
	Pascal Listings	819
	Requirements	819
	Instructions	819
	C Listings	820
	Requirements	820
	Instructions	820
	C++ Listings	820
	Requirements	820
	Instructions	821
	Object-Oriented Listings	821
	Requirements	821
	Instructions	821

Windows Listings	822
Requirements	822
Instructions	822
All Listings	823
Requirements	823
Instructions	823
Errors During Assembly	824
B File Directory	825
C Answers to Exercises	829
Chapter 1	830
Chapter 2	831
Chapter 3	832
Chapter 4	833
Chapter 5	834
Chapter 6	836
Chapter 7	841
Chapter 8	843
Chapter 9	846
Chapter 10	850
Chapter 11	851
Chapter 12	854
Chapter 13	856
Chapter 14	859
Chapter 15	864
Bibliography	867
Index	871

Preface

Programmers are always arguing about which language is the best. Try to win C programmers over to Pascal and they'll tell you to go eat quiche. Try to get Pascal pundits to recognize the fresh look of BASIC and you'll probably be told where to GOTO. And don't even think of suggesting to FORTH fans that theirs is an obscure language, hardly suitable for any "serious" work—unless, that is, you're prepared to be threaded up and tarred right out of town.

I try to avoid getting into such arguments, which I find to be more amusing than significant. What if, instead of programmers, the debaters were chefs arguing about whether a soufflé will be more heavenly if the recipe is written in French, English, or Spanish? Of course, that's silly—you'll get the same results no matter what language spells out the ingredients. Flour is flour, right?

The same is true in programming. All high-level languages must translate their instructions into native machine code to run on computer processors such as the PC's 8086, 80386, or 80486 microprocessors, covered in depth in these pages. With this in mind, it's easy to see that, when stripped bare (as the cover of this book seems to suggest), all programming languages actually speak the same tongue—forked as it may be in some cases.

So, no matter what high-level language you favor, it makes sense to learn assembly language, the only computer language that lets you talk to a naked computer in its own dialect. In the following chapters, I'll concentrate mostly on how to write entire programs in assembly language, paying special attention to developing reusable library modules. There are chapters that explain how to mix assembly language with Pascal, C, and C++. This new edition also includes chapters on Turbo Assembler's object-oriented features, and on Windows application development using assembly language.

To the beginners among you, I add this note: If you've heard that assembly language is difficult, don't believe it. With Turbo Assembler's many features including Ideal mode, and with the guiding hand of the marvelous Turbo Debugger, you'll soon be twiddling bits with the best of them. Quiche indeed!

Tom Swan

Acknowledgments

They say that writing is a lonely profession. Fortunately, in writing this book's first and second editions, I've been anything but alone. Those who contributed their talents to this book include, at Sams, Greg Croy, Richard Swadley, and Fran Hatton; at Waterside Productions, my agents, Bill Gladstone, Matt Wagner, and staff; at Borland International, Nan Borreson; and at home, my parents Reyer and Mary Swan, who looked after the house and mail. Thank you all for helping to make it possible for me to write this book and survive the experience.

I owe special and warm regards to Richard Day, to whom this book is dedicated, for love, friendship, and understanding. To Fred McGeehan for stimulating conversation and great coffee. And to Anne who endures me, God knows how sometimes.



PART

Programming with Assembly Language

1

CHAPTER

Introduction

- Learning Assembly Language, 4
- Advantages of Assembly Language, 7
- Disadvantages of Assembly Language, 8
- Hardware Requirements, 9
- Software Requirements, 10
- Microsoft Windows Users, 11
- How to Use This Book, 11
- How to Organize Your Disks, 13
- Entering Program Listings, 15
- Getting More Help, 16
- Summary, 16
- Exercises, 17

Learning Assembly Language

I remember when I discovered assembly language. The nearest I've come to experiencing the same elation was the day I first balanced a two-wheeler, wiggling my way down our street, my father's thumb no longer snagging my belt, my fear of falling melting like bee's wax in the sun.

Mastering assembly language gives many programmers the same sort of astonished joy. Why? Because assembly language is the only computer language that lets you talk to a computer in its native tongue, commanding the hardware to perform exactly as you say. If you like to be in charge, if you like to control things, if you're interested in details, you'll be right at home with assembly language.

My goal in writing this book is to offer a guiding hand as you find your own balance in assembly language programming. Read the rest of this chapter for suggestions on how to prepare your disk and how to make the best use of the book's various parts and pieces. Enter the examples—or examine the files on the accompanying disk—puzzle through the exercises and projects at the end of each chapter, and don't be afraid to experiment on your own. Above all, have fun! (If you become frustrated, see “How To Get More Help” later in this chapter.)

You Take the High Level and I'll Take the Low Level

Even though it may appear that a computer “understands” high-level languages such as BASIC, Pascal, or C, all computer programs actually run in *machine language*, the coded bytes that drive the computer's central processing unit (CPU). For this reason, *machine code* is a better term for this lowest of low-level computer languages—the only language the CPU knows. Because CPUs can't directly execute C and Pascal statements, programs in these and other high-level languages must be *compiled* (translated) to machine code before the programs can be used. Similarly, a program written in an interpreted language such as BASIC or LISP must be translated to machine code, although in these cases, the translation happens invisibly while the program runs, usually one statement at a time.

Assembly language programs are also translated to machine code by a program called an *assembler*. Despite this similarity with other languages, assembly language is neither high nor low level; it's sort of stuck in between. Unlike C and Pascal statements, which might translate to dozens of machine-code bytes, assembly language instructions directly relate to individual machine codes—the major distinction between assembly language and high-level computer languages. All languages have their good points, but only assembly language allows you to write programs directly in the CPU's indivisible instruction set.

NOTE

Experienced C programmers may be frowning because they know that some C statements—also some Turbo Pascal statements—translate to single machine codes. FORTH language fans may also argue that their lexicon provides direct low-level access. Even so, while C and FORTH may not be the highest of high-level languages, they're still miles above assembly language's special access to the CPU.

By the way, shaded boxes such as this one are used throughout this book to point out interesting views and other scenery as you travel through the chapters.

If assembly language and machine code enjoy a one-to-one relationship, why not program directly in machine code? The answer is: Machine code is just too cumbersome. While it's true that very early computer programs were programmed in machine code, today this is almost never done—and with good reasons. For example, many machine codes depend on their relative positions in memory. Also, in pure machine code, there are no named variables, and there is no way except by fixed addresses to tell a program where values and subroutines are stored. This means that if you change one instruction in a 10,000-byte machine-code program, you may have to modify 9,000 other codes as well!

Obviously, such hard labor lacks appeal for fun-loving programmers, whose brains, despite popular opinion, are not bitmapped and wired with AND gates. Programming directly in machine code is drudge work. Programming in assembly language gives you the best of two worlds, combining direct access to the computer's lowest levels with features like named variables and numeric expressions that make programming in high-level languages practical and enjoyable. With assembly language, you can change one instruction and then feed the modified code to Turbo Assembler, which translates the entire program to machine code. Some people say that assembly language is only one step above machine code. That's true, but it's a *big* step.

Developing Mental Pictures

Because assembly language statements directly translate to the CPU's fundamental machine codes, the best way to become a crack assembly language programmer is to develop good mental models of a computer's inner workings. The more you know about how your computer is constructed and the more familiar you are with the functions in DOS and the ROM BIOS on PCs, the better you will be able to apply your knowledge of assembly language when writing computer programs.

In later chapters, I concentrate on subject areas that explain in detail how to control various parts of a PC's hardware. For example, one chapter deals with the keyboard and display, another chapter explains serial communications. The goal in these chapters is to help you develop mental models of what really goes on inside your computer, while showing how to control the computer's devices with assembly language statements.

NOTE

As you probably know, MS-DOS and PC-DOS are pretty much birds of the same feather. To keep things simple, this book uses *DOS* to mean both of these Disk Operating Systems. The BIOS (for *Basic Input-Output System*) refers to routines—yes, in machine code—stored in Read-Only Memory chips. Generally speaking, the BIOS drives the computer hardware, whereas DOS provides a standard interface to that hardware, which may vary from system to system.

Preventive Debugging

Some people find it difficult to make the intuitive leap between a program's written statements and the actions that occur when the program runs. This is especially so with cryptic assembly language instructions such as `mov ax, bx` and `xor cx, cx`, which appear to have no connection with displaying characters on-screen, printing text, and dialing up remote systems via modems. Comprehending a program by mentally executing out-of-context assembly language statements can frustrate even the most mechanical of thinkers. But don't let such moments ruin your day. This is hard for *everybody*.

Using a program such as Turbo Debugger, included with most versions of Borland C++ and Pascal, is one way—maybe the best way—to improve your ability to understand an assembly language program's actions. Many people consider a debugger to be useful only for helping to fix a broken program. But a debugger can offer preventive medicine as well as a cure. With Turbo Debugger, you can peer into memory as your program runs, watch processor registers change, see memory bytes take on values, and step through a program's actions in slow motion. You can also view your assembly language statements along with the corresponding machine code, seeing exactly what Turbo Assembler generates from your program text.

Using Turbo Debugger to examine running programs helps you to understand the purpose of specific assembly language statements. In future chapters, I'll often suggest using Turbo Debugger to check registers and flags, to examine sections of memory, and to run your program up to temporary stopping places, letting you reflect at your own speed on what the program is doing every step of the way.

NOTE

I used two undefined terms in the preceding section, *register* and *flag*. A register is a small amount of volatile memory inside the CPU processor. As you'll learn, various machine-code instructions operate directly on CPU registers. A flag is a single-bit switch, also inside the processor and also directly affected by certain machine codes. You take a closer look at these items later.

Striving for the Ideal

Turbo Assembler is actually two assemblers in one. Normally, Turbo Assembler processes programs written in the popular *MASM syntax* (MASM is short for Microsoft Assembler). For assembling programs downloaded from bulletin boards, copied from time-share systems, or gleaned from MASM books, this is the method to use.

Examples in this book use Turbo Assembler's *Ideal mode*, which I believe to be superior to MASM syntax—especially for writing stand-alone assembly language programs. With Ideal mode, programs assemble faster and are less prone to developing bugs that can result from MASM's many known quirks and syntactical freedoms. (The Turbo Assembler User's Guide spells out the differences between MASM and Ideal mode instructions.)

In addition to extra speed and the absence of quirky behavior, Ideal mode offers other advantages. Structures (similar to Pascal records or C structures) can repeat member field names. Assembler directives are easier to remember and use. Equated symbols and expressions always have predictable values. And formats for various memory-addressing modes must conform to generally recognized guidelines. If you don't yet grasp the significance of some of these items, you'll have to trust my opinion: Ideal mode is what PC assembly language programmers have needed for years.

Don't be concerned that by learning Ideal mode, you'll be shut out from using the thousands of lines of MASM code in the public domain. After learning Ideal mode, you'll be able to read and understand MASM-mode programs with little effort. Most differences between the two modes are subtle—a spelling change here, an operand reversal there. I regularly read and work on programs in both syntaxes without difficulty, but I prefer using Ideal mode for new projects.

Advantages of Assembly Language

Many books list in detail the advantages and disadvantages of programming in assembly language. The advantages are rather obvious and well known: low-level access to the computer and the promise of top speed that comes from total control over the CPU. High-level

language programs tend to run more slowly than assembly language programs because of the way a C or Pascal compiler uses standard methods to read and write variables, to call subroutines, and so on. In assembly language, if you want to store a variable in a readily accessible processor register, that's your business.

Despite many claims to the contrary, however, there is no guarantee of speed in assembly language programming. An experienced C or BASIC programmer can write programs that run circles around bungled assembly language jobs. Assembly language gives you nothing more than the *opportunity* to write programs with optimum efficiency—a worthy goal that requires time and patience to achieve in practice. But if speed is your aim, you can at least be sure of one thing: You've come to the right race track.

Disadvantages of Assembly Language

The main disadvantages of assembly language programming most often cited are: increased risk of bugs, reduced portability, and the absence of library routines to perform tasks such as displaying strings or reading disk-file data. Let's take these one by one.

Increased risk of bugs I don't agree with this criticism. Bugs are the result of carelessness, not the result of features in a computer language. You can write buggy programs in any language, and you can write bug-free programs in assembly language. I do agree that simple bugs in assembly language programs are often more serious than mistakes in C or Pascal. Because assembly language gives you complete control of the CPU, a single haywire statement can cause a system crash more readily than in high-level languages, where a compiler generates the machine code for you. One way to deal with this problem is to run your programs under the control of Turbo Debugger, which can help reduce the likelihood of a crash.

NOTE

While writing this book, I experienced what many assembly language programmers expect as routine—crash after crash, requiring me to reboot or switch off power to recover. Then, as I became more familiar with Turbo Debugger, my frequent crashes practically disappeared! Today, I won't run a new section of code until it passes the Turbo Debugger crash test.

Reduced portability By nature, assembly language is tied to the CPU for which a program is designed. Assembly language instructions translate directly to machine code and, therefore, will run only on computers using a compatible CPU. *Porting* (transferring) an assembly language program from one computer to another with a different processor usually means starting over from scratch. I have to agree with this gripe. To gain the advantages of assembly language, you must give up the ability to port programs easily to other systems. You can't have it both ways.

Absence of library routines All high-level languages have commands to perform common jobs such as displaying strings, printing text, and processing disk files. Also, high-level languages let you write mathematical expressions such as $(x * 2 + 8)$. Assembly language lacks such niceties, requiring you to write custom code for these and other tasks. Although this fact is true, the argument misses the primary point of gaining total control over a computer's resources compared with giving up that control to a high-level language's runtime library—the opportunity to achieve optimum efficiency and top speed. Furthermore, many assembly language libraries are available containing routines to perform typical high-level operations. You may have to work a little harder, but there's nothing you can do in a high-level language that you cannot do in assembly. Besides, if you must use certain features in C, C++, or Pascal, you can always combine high-level languages with assembly language, as Chapters 12 and 13 explain.

Hardware Requirements

To make the best use of this book, at a minimum you should have the following equipment:

- IBM PC, XT, AT, PS/2, or 100% compatible
- 384K memory (256K if you don't use Turbo Debugger)
- One or two floppy disk drives
- Monochrome or color display

For simplicity, I'll use *PC* to refer to this basic system, which is perfectly suitable for entering and running most of the examples in this book. You'll probably find the going easier if you also have any of the following optional equipment:

- Printer
- Hard disk drive
- Additional memory

Almost all the programs in this book will run on any IBM computer with an 8086, 8088, 80286, 80386, 80486, or Pentium processor. A few programs here and there, however, require an 80386 or 80486 (or equivalent). Windows programs require a hard disk drive, but then, so does Windows itself.

NOTE

I frequently refer to the "8086 processor" and discuss "8086 programming" methods. Except where specifically noted, such references apply equally to the logically equivalent 8088 and to the 80286, 80386, 80486, and Pentium processors—all of which recognize the same 8086

instruction set. Some books, tutorials, and articles use terms such as *80x86*, *8086/88*, and *iAPX-86* to refer to the family of Intel processors found in all PCs. This book uses the simpler *8086* instead.

Software Requirements

In addition to the required hardware listed in the preceding sections, at a minimum you need to have the following software:

- Turbo Assembler 4.0 and Turbo Debugger 4.0
- DOS 4.01 or a later version
- Optional: Microsoft Windows 3.1 or a later version (for the programs in Chapter 15)

You can probably use most of the programming techniques in this book with Turbo Assembler 3.2 and Turbo Debugger 3.2 shipped with Borland Pascal 7.0. I tested all program listings, however, with Turbo Assembler 4.0.

For entering program listings, you also need a text editor, which Turbo Assembler does not supply. Any one of the following editors will work just fine:

- The editor in Borland Pascal or C++
- Brief
- VEdit Plus
- EDIT (from MS-DOS)
- Epsilon
- WordStar (in nondocument mode)
- SideKick or SideKick Plus notepad

If you have a Borland language, use the editor built into the integrated version of your compiler. You can also use any plain ASCII text editor, but don't use a word processor such as WordPerfect, which adds formatting codes to text.

After entering or viewing the disk file for each program, use your editor's "exit-to-DOS" command to return to the DOS prompt and then follow the instructions listed and explained before each program example. After assembling and experimenting with the program, type EXIT and press Enter to return to editing. If your text editor lacks a similar command to return to DOS, you'll have to quit the program, assemble, and then reload your editor to enter the next example. Some editors such as Brief can run Turbo Assembler directly, but you still have to exit to DOS to run the resulting programs.

Microsoft Windows Users

If you are running Microsoft Windows, open a DOS prompt window for editing, assembling, and trying out this book's sample programs. Except for the Windows programs in Chapter 15, you cannot assemble and run this book's listings directly as Windows applications.

Also, due to the way Windows takes over control of DOS and the ROM BIOS, a few programs in this book may not run correctly in a DOS prompt window. I'll warn you in advance of any such problems. If you experience trouble running some programs, exit Microsoft Windows and try again from a DOS prompt.

How To Use This Book

Beginners should read this book from front to back. The text and program examples were carefully selected to avoid using terms not yet introduced. If you read chapters out of order, be aware that many program examples use modules introduced earlier. For example, you may not understand the programs in Chapter 9 if you did not read about the modules those programs use from previous chapters. To find hints about specific topics, refer to the table of contents, and the subject index.

About the Chapters

Each chapter in this book follows the same general organization, designed so that you can use the book both as a tutorial and as a reference. A flyleaf page lists the chapter's major topics. Following this comes the chapter text, which ends with a summary, plus a list of exercises to test your knowledge and, except for this chapter, suggested projects. Answers to all exercises are included near the back of the book. I did not provide answers for suggested projects.

The book is divided into three parts. Part I, "Programming with Assembly Language," is a tutorial on 8086 assembly language. Part II, "Application Programming," describes how to mix assembly language with Pascal, C, and C++, how to use Turbo Assembler's object-oriented features, and also how to write Windows applications using assembly language. Part III, "Reference," lists processor and Turbo Assembler instructions. The following notes briefly describe each chapter.

- Chapter 1, "Introduction," introduces concepts of assembly language programming, explains how to use this book, and makes other suggestions, as you no doubt know if you've read this far!
- Chapter 2, "First Steps," describes the parts of an assembly language program, gets you started using Turbo Assembler and Turbo Debugger commands, and explains how to create .EXE and .COM code files on disk.

- Chapter 3, “A Bit of Binary,” reviews the basics of the binary number system, concentrating on concepts that are vital in assembly language programming. Beginners: Don’t skip this chapter! Experts: Skim the material for a quick refresher.
- Chapter 4, “Programming in Assembly Language,” explores the difficult subject of memory segmentation and introduces most of the 8086 instruction set.
- Chapter 5, “Simple Data Structures,” explains addressing modes and shows how to reserve memory for variables. You’ll also learn how to use the TLIB utility program to construct a library file containing this book’s modules, required by examples in future chapters.
- Chapter 6, “Complex Data Structures,” expands on the topics introduced in Chapter 5, showing how to create advanced multifield structures, unions, arrays, and packed bit-field records.
- Chapter 7, “Input and Output,” gives advice on reading the keyboard and writing text to the standard output file (usually the display) from assembly language. Some examples call DOS and ROM BIOS routines for these tasks. Others show how to improve display performance by writing directly to video RAM buffers.
- Chapter 8, “Macros and Conditional Assembly,” explains how to combine repetitive instructions into macros, adding custom commands to assembly language. Also discussed are conditional assembly techniques for writing multipurpose programs that assemble differently on demand.
- Chapter 9, “Disk-File Processing,” covers assembly language techniques for creating, reading, and writing file data stored on disk. Reading disk directories is also explained.
- Chapter 10, “Interrupt Handling,” dives into the intricate and often confusing subjects of writing interrupt service routines, tapping into the PC timer, and accessing serial I/O ports.
- Chapter 11, “Advanced Topics,” discusses some of the less frequently used (and, perhaps, poorly understood) Turbo Assembler techniques.
- Chapter 12, “Mixing Assembly Language with Pascal,” unravels the tricky secrets of mixing assembly language with Turbo Pascal, with the goal of optimizing program performance.
- Chapter 13, “Mixing Assembly Language with C and C++,” shows how to mix assembly language with Borland C++, emphasizing optimization as in Chapter 12.
- Chapter 14, “Programming with Objects,” explains how to use Turbo Assembler’s object-oriented-programming (OOP) features, and also suggests advantages and disadvantages of using OOP techniques in assembly language.

- Chapter 15, “Programming for Windows,” provides guidelines for writing Windows applications purely in assembly language. (The programs in this chapter require Microsoft Windows 3.1 or a compatible later version.)
- Chapter 16, “Assembly Language Reference Guide,” is an alphabetic reference to the instruction sets for 80x86 processors (excluding protected-mode instructions, not used in application programming).
- Chapter 17, “Turbo Assembler Reference,” lists the syntax for Turbo Assembler’s predefined symbols, operators, MASM- and Ideal-mode equivalents, and directives.

About the Modules

Many of the programs are constructed as separate modules, which you can assemble and store in a library file for other programs to share. Instructions are given for creating and using a suggested library file named MTA.LIB, but feel free to store the modules in another file if you prefer.

Refer to the index to find program examples, demonstrations, shells (ready for filling with your own code), Pascal and C external routines, macros, and other files. In addition to the book’s many tested examples, major library modules include:

- STRINGS.ASM: package of ASCIIZ string subroutines
- STRIO.ASM: routines for reading and writing ASCIIZ strings
- BINASC.ASM: conversion utilities for strings and numbers
- SCREEN.ASM: memory-mapped video procedures
- KEYBOARD.ASM: routines for reading key presses including function keys
- DOSMACS.ASM: macros for calling DOS functions
- DISKERR.ASM: routines for deciphering disk errors
- PARAMS.ASM: routines to read DOS command-line parameters
- ASYNCH.ASM: interrupt-driven serial I/O routines

How To Organize Your Disks

Hard Drives

Hard disk drives are more widely used than they were when this book’s first edition was published. If you don’t have a hard drive, see the next section, “Floppy Disk Drives,” for help setting up a floppy-disk based system.

The steps for installing Turbo Assembler differ depending on the version you have. Some versions are automatically installed with a Borland Language product such as Pascal 7.0. Others must be installed in an existing directory (Turbo Assembler 4.0, for example, is typically installed in C:\BC4\BIN, the “binaries” directory for Borland C++.)

Follow the steps in your language User’s Guide for installing Turbo Assembler. To check whether your installation is correct, go to a DOS prompt (open a DOS window if you are running Microsoft Windows), then enter `tasm`. This should display the following lines followed by a list of command-line options:

```
Turbo Assembler Version 4.0 Copyright (c) 1988, 1993 Borland International
Syntax: TASM [options] source [,object] [,listing] [,xref]
```

If you can’t seem to run TASM, the cause is probably a mistake in your system PATH. Make sure that a command such as the following is in your computer’s plain-text AUTOEXEC.BAT file:

```
PATH=C:\WINDOWS;C:\DOS;C:\BC4\BIN
```

Borland Pascal 7.0 users should change C:\BC4\BIN to C:\BP\BIN (or to the directory where you install Pascal’s executable code files).

Some versions of Turbo Assembler, such as those that used to be supplied with the discontinued Borland product, Application Frameworks, install Turbo Assembler and Turbo Debugger in separate directories. In that case, you might have to set your path to something like this:

```
PATH=C:\WINDOWS;C:\DOS;C:\TASM;C:\TD
```

Floppy Disk Drives

If you do not have a hard drive, you can probably use Turbo Assembler and most of this book’s programs from floppy disks. You cannot run some of the more sophisticated examples, such as those that require Microsoft Windows, but you can still use this book to learn assembly language techniques on floppy-disk systems with two drives A: and B:. Used PCs are available for very little money, so this is an inexpensive way to get started programming.

Create a boot disk with operating system files, COMMAND.COM (a DOS program that lets you give commands and run other programs from a DOS prompt), your text editor, and Turbo Assembler. To create this disk, boot your computer to your DOS master disk in A:. Insert a blank disk into B: and enter the following command (the `/s` option transfers system files to the disk):

```
format b: /s
```

Also copy any other programs you need. For example, to use the DOS EDIT program for entering and reviewing program listings, copy it to your disk (the exact command depends on where the EDIT.EXE file is located—but not all DOS versions provide it):

```
copy a:\edit.exe b:
```

Finally, copy Turbo Assembler's executable code file, TASM.EXE, to the disk:

```
copy tasm.exe b:
```

Again, the exact command depends on your version of Turbo Assembler. Some versions can be installed directly to a floppy disk. For additional installation instructions, refer to the User's Guide that came with your assembler or compiler.

After creating your Turbo Assembler floppy disk, edit or create a plain text AUTOEXEC.BAT file with a PATH statement such as:

```
PATH=A:\;B:\
```

When you reboot your computer, this statement makes it possible to run programs from drives A: and B:, regardless of which is the current drive. The only disadvantage of this technique is that you must have formatted disks in both drives at all times, or you may receive a "Not ready" error. If this happens, press R to retry the command after inserting a disk.

Older Turbo Assembler Versions

You can probably use many of this book's programs with older versions of Turbo Assembler. Depending on your version, however, you may not be able to use object-oriented features or write Windows applications. For best results, you should upgrade to Turbo Assembler 4.0. If you have version 3.0, you can probably get by, but I tested the programs in the book *only* with version 4.0.

If you cannot get a program to run with your version, try the original listing file supplied on this book's disk. See the disk installation instructions at the end of this book for instructions on using these first-edition files.

Entering Program Listings

If you are typing the listings, using your favorite text editor, enter the example programs exactly as printed, except for the numbers and colons at the left. *These numbers are for reference only—don't type them.* Try to match the indentations in the listings. You don't have to indent every line exactly as printed, but so you can better understand the assembly language instructions, try to keep columns aligned more or less as they are in the book. Use your editor's tab key to save typing time.

Each example program is numbered by chapter (1.5, 4.3, and so on) with the name of the disk file shown next to the program number (BINASC.ASM ASYNCH.ASM, and so forth). Save each program with the suggested disk-file name. Some programs depend on these filenames; therefore, if you change the name of one program file, you may have difficulty running other programs later.

NOTE

All files are included on the disk at the back of this book. To use these files, follow the disk installation instructions inside the back cover.

Getting More Help

If you need more help, if you have a burning question, if you find a mistake (horrors!) in this book, what should you do? First, don't panic. Second, don't phone. Sorry, but if I took the time to speak to all who telephone, I'd never get books like this one finished. That doesn't mean I don't want to hear from you. I love to receive letters from readers, and I always try to write back. Limit your questions to one or two, but don't send disks—I can't return them. If you want to get in touch, here's how:

- Write to Swan Software, P.O. Box 1303, Key West, FL 33040.
- Send CompuServe Email to 73627,3241.
- Write to me in care of Sams Publishing.

Summary

The purpose of this book is to guide you through the often difficult world of assembly language programming for IBM PCs and compatibles running DOS and Windows. Learning assembly language does not have to be difficult, despite what you may have heard. This book's many examples and topics will help you to acquire programming skills that even many professional programmers lack. The published programs are modular and well tested, and many can be extracted for use in your own work.

Assembly language is a convenient method for writing machine-code programs. Although early programmers wrote computer programs directly in low-level machine code, few programmers would do the same today. Assembly is one step above machine code, while C, Pascal, BASIC, Prolog, and others are high-level languages. Because assembly language is closely tied

to the machine code of the computer processor, a good way to learn assembly language programming is to develop useful mental models of the computer's inner workings. Also, using Turbo Debugger as a teaching tool helps explain how assembly language programs operate.

Turbo Assembler runs in two modes, MASM and Ideal. The example programs in this book are all written in Ideal mode, superior in many ways to MASM syntax.

Assembly language—like all computer languages—has its advantages and disadvantages. The major advantages are the promise of extra speed plus the ability to program the computer's processor directly. The major disadvantage is that assembly language programs will run only on the processor for which they are written.

Line numbers added to all example programs in this book are purely for reference. When entering listings, don't type the numbers and colons. All programs are provided on the disk at the back of the book. For best results, you should have Turbo Assembler 4.0. First edition files are provided on disk for use with earlier Turbo assembler versions.

Exercises

- 1.1. Why is "machine language" an improper term?
- 1.2. What is meant by the terms "high level" and "low level" in describing computer languages?
- 1.3. What is the major difference between a high-level language and assembly language?
- 1.4. Why don't programmers write software directly in machine code anymore? Why do you think they ever did?
- 1.5. How can a debugger help you to learn assembly language?
- 1.6. What is a register?
- 1.7. What is a flag?
- 1.8. What are some of the advantages of Turbo Assembler's Ideal mode?
- 1.9. What are the main advantages of programming in assembly language?
- 1.10. What are the main disadvantages of programming in assembly language?

2

CHAPTER

First Steps

- Assembly Language: Parts and Pieces, 20
- Assembling a Program, 30
- Understanding Object Code, 32
- Command-Line Options, 33
- Dealing with Errors, 34
- Introducing Turbo Debugger, 37
- Writing .COM and .EXE Programs, 42
- Summary, 49
- Exercises, 50
- Projects, 51

Assembly Language: Parts and Pieces

Assembly language is an odd-looking computer language. The program source-code text is sprinkled with three- and four-character unpronounceable words like `c1i`, `movsb`, and `sbb`, appearing to the untrained eye to follow no preplanned order or to have any relationship with one another. And no matter how long you stare at the programmer's comments—the text preceded by semicolons at the ends of most assembly language lines—the words often seem to have no connection with the program's instructions.

One reason for this apparent (but deceiving) disarray is the lack of built-in control structures in assembly language. There are no REPEAT-UNTIL or WHILE constructions to group repetitive actions. There are no IF-THEN-ELSE or CASE statements to make decisions, and there is no assignment symbol to initialize named variables. Performing such high-level actions requires you to construct programs from a single set of low-level machine-code instructions, giving the assembly language source-code text a homogenized sameness that tends to hide the inner meaning of what the program is doing. Also, assembly language is line-oriented, not statement-oriented as are C, Pascal, and BASIC. Consequently, many lines of code are usually needed to perform even simple operations like adding numbers or initializing variables.

There is order in the apparent jumble, however. Even though Turbo Assembler permits programmers to organize their code in numerous styles, most assembly language programs naturally divide into five main sections: *header*, *equates*, *data*, *body*, and *closing*. (These are my own terms, by the way—there are no standard names for the parts of an assembly language program.) The *header* contains setup information. The *equates* area declares symbols to which you assign various expressions and constant values. The *data* section declares variables to be stored in memory. The *body* contains the actual program code. The *closing* marks the end of the source-code text. Let's examine each of these parts more closely.

The Header

The header begins an assembly language program. In the header are various commands and directives, none of which produces any machine code in the final product. The header instructs the assembler to perform certain actions, generating the finished code file according to various options at your disposal.

Figure 2.1 shows a sample header, similar to the header at the beginning of most example programs in this book. (This isn't a complete program—so don't bother trying to assemble it.) The optional `%TITLE` line describes the purpose of the program, causing the text between quotes to print at the top of each listing page—that is, if you ask Turbo Assembler to print a listing. The `IDEAL` directive switches on Turbo Assembler's Ideal mode. Leave this out to assemble a program written in Microsoft Macro Assembler (MASM) syntax.

```

%TITLE "Test Header--Don't Assemble!"
IDEAL
MODEL    small
STACK    256

```

Figure 2.1. *Typical assembly language header.*

Next comes the `MODEL` directive, which selects one of several memory models (see Table 2.1), most of which are used only when combining assembly language with Pascal or C. In stand-alone assembly language programming, the *small* model is usually the best choice. But don't be fooled by the name. The small memory model gives you up to 64K of code plus another 64K of data for a total maximum program size of 128K—practically a bottomless pit in the memory-efficient world of machine code.

The `STACK` directive in Figure 2.1 reserves space for the program's stack, an area of memory that stores two kinds of data: values temporarily stored by or passed to subroutines and the addresses to which subroutines return control. (Stacks also come into play during interrupts, a subject for Chapter 10.) Manipulating the stack is an important assembly language technique, which I cover in more detail in the chapters to come. The value after the `STACK` directive tells Turbo Assembler how many bytes to reserve for the stack segment—256 bytes in Figure 2.1. Most programs require only a small stack, and even the largest programs rarely require more than about 8K.

Table 2.1. Memory Models.

<i>Name</i>	<i>Code</i>	<i>Data</i>	<i>Assumptions</i>	<i>Description</i>
tiny	near	near	cs = dgroup ds = ss = dgroup	Code, data, and stack in one 64K segment. Use for .COM programs only.
small	near	near	cs = _text ds = ss = dgroup	Code and data in separate 64K segments. Use for small- to medium-size .EXE programs. Best choice for most stand-alone assembly language programs.
medium	far	near	cs = <module>_text ds = ss = dgroup	Unlimited code size. Data limited to one 64K segment. Use for large programs with minimal data.

continues

Table 2.1. continued

<i>Name</i>	<i>Code</i>	<i>Data</i>	<i>Assumptions</i>	<i>Description</i>
compact	near	far	cs = <code>_text</code> ds = ss = <code>dgroup</code>	Code limited to one 64K segment. Unlimited data size. Use for small- to medium-size programs with many or very large variables.
large	far	far	cs = <code><module>_text</code> ds = ss = <code>dgroup</code>	Unlimited code and data sizes. Use for large program and data storage requirements, as long as no single variable exceeds 64K.
huge	far	far	cs = <code><module>_text</code> ds = ss = <code>dgroup</code>	Unlimited code and data sizes. Identical to the large memory model. (The huge model is provided for compatibility with high level languages.)
tchuge	far	far	cs = <code><module>_text</code> ds = <code>nothing</code> ss = <code>nothing</code>	Same as the large memory model, but with different register assumptions. Use mostly for Turbo C and Borland C++ programming.
tpascal	near	far	cs = <code>code</code> ds = <code>data</code> ss = <code>nothing</code>	Provided for backwards support for early versions of Turbo Pascal. Obsolete for Borland Pascal.
flat	near	near	cs = <code>_text</code> ds = ss = <code>flat</code>	For use with OS/2 only; otherwise the same as the small memory model.

Equates

After the program header come various constant and variable declarations. In assembly language, constant values are known as *equates*, referring to the EQU directive that associates values with identifiers such as `MaxValue` and `PortAddress`. Turbo Assembler allows you to use EQU or, for numeric values only, an equal sign (=).

NOTE

Equates may appear anywhere in a program without restriction. To make your programs more readable, however, place most equates just after the program header.

Using equated identifiers instead of “magic” numbers like 0100h and 0B800h lets you refer to expressions, strings, and other values by name, making programs easier to read and modify. (Literal values are magical because of the way they can hide a program’s secrets.) Here are a few sample equates that could follow the header in Figure 2.1:

```
Count    EQU 10
Element  EQU 5
Size     = Count * Element
MyBoat   EQU "Gypsy Venus"
Size     = 0
```

Although most equated symbols simply stand in place for their associated values and expressions—similar to the way constants are used in Pascal and C—there are several tricky rules to remember when creating and using assembly language equates:

- After declaring a symbol with EQU, you cannot change the symbol’s associated value. Redefining an equated symbol (changing Count to 11, for example) is never allowed.
- The same rule is not true for symbols declared with an equal sign (=), and you can change these values as often as you like. Notice how the sample equates change the value of Size from 50 to 0. You can do this anywhere in the program, not just in the equate section.
- EQU can declare all kinds of equates including numbers, expressions, and character strings. The equal sign (=) can declare only numeric equates, which can be literal values like 10 and 0Fh, or expressions such as `Count * Size` and `Address + 2`.
- Equated symbols are not variables—neither the symbols nor their associated values are stored in the program’s data segment. Assembly language instructions can never assign new values to equated symbols, regardless of whether EQU or = was used to declare the symbols.

- Although you can declare equates anywhere in your program, it's usually best to place them near the beginning where they are most visible. An equate buried deeply inside the program's code can easily become the source of a hard-to-find bug.
- Expressions declared with EQU are evaluated later when the equated symbol is used in the program. Expressions declared with an equal sign (=) are evaluated at the place where the equated symbol is defined. The assembler stores the equated *text* of EQU symbols but stores only the *value* of = symbols.

This last rule is easier to understand by examining a few more examples. Suppose you have the following three equates:

```
LinesPerPage = 66
NumPages    = 100
TotalLines  = LinesPerPage * NumPages
```

Obviously, `TotalLines` equals the result of multiplying `LinesPerPage` times `NumPages`, or 6,600. (As in most computer languages, an asterisk (*) indicates multiplication.) Because `TotalLines` is declared with the equal sign (=)—indicating a numeric value—the expression is evaluated immediately, associating the result of the expression with `TotalLines`. If you assign a new value to `NumPages` elsewhere in the program, the computed value of `TotalLines` does not change. A different effect occurs, however, if you declare `TotalLines` with EQU:

```
TotalLines EQU LinesPerPage * NumPages
```

Internally, Turbo Assembler stores the actual text, not the calculated result, of an expression along with all EQU symbols—in this case, the text of the expression `LinesPerPage * NumPages`. Later in the program when you use `TotalLines`, the assembler inserts this text as though you had typed those characters at this place in the source code. The expression is then evaluated to produce a final value. If you assign new values to one or both of the symbols used in the expression—either `NumPages` or `LinesPerPage`—the evaluated result changes accordingly.

This ability to affect the result of equated expressions can be useful. You can program one module with an equated expression that changes value depending on equates in other modules. Be aware of the subtle difference between = equates and those that you create with EQU. This is a feature that can also create bugs if used carelessly.

The Data Segment

A program's data segment usually appears between the equates and the program's instructions. It's possible, but rarely useful, to declare data segments elsewhere and to have multiple data segments strewn throughout the program text. Despite this feature, your assembly language programs will be easier to read and modify if you follow the simpler plan suggested here, declaring all your variables between the equates and code.

Begin your program's data section with the `DATASEG` directive. This tells the assembler to store variables inside the program's data segment, which can be as large as 64K in the small memory model. The data segment can store two kinds of variables: *initialized* and *uninitialized*. When the program runs, initialized variables have preassigned values, which you specify in the program text and which are stored inside the program's code file on disk. These values are automatically loaded into memory and are readily available when the program runs. Uninitialized variables are identical to initialized variables in every way except that uninitialized variables do not occupy space in the program's code file and, consequently, have unknown values when the program runs. Because of this, declaring a large uninitialized variable—an array of consecutive values or a large buffer to be filled from a disk file, for example—will reduce the size of the program's code file.

NOTE

To prevent uninitialized variables from being stored inside the assembled code file, the variables must be declared after the last initialized variable in the program source-code text. Uninitialized variables declared between other initialized variables take up space in the assembled code and needlessly increase the program's code-file size on disk.

Reserving Space for Variables

Although Chapter 5 describes in detail how to declare variables in a program's data segment, a few simple examples introduce several important concepts that you need to know now. Here's a typical data segment as it might appear after the program's header and equates:

```
DATASEG
numRows    DB    25
numColumns DB    80
videoBase  DW    0B00h
```

First comes the `DATASEG` directive, informing Turbo Assembler to allocate space for the program's data segment. Three variables are then declared: `numRows`, `numColumns`, and `videoBase`. As a rule, I prefer to capitalize my equated constants (`Count`, `NumPages`, and so on) and to begin variables with lowercase letters as shown here. This is an arbitrary convention, and you can type symbols in uppercase or lowercase as you prefer. Also, some programmers use underline characters to make multiword identifiers more readable, for example, writing `num_rows` and `video_base` instead of the mixed case style shown here.

`DB` (define byte) and `DW` (define word) are the two most common directives used to reserve space for a program's variables. You'll use these directives repeatedly. Unlike high-level languages where the actual location of variables in memory is usually unimportant, in assembly language, you must reserve space in memory for your variables and, in the case of uninitialized

variables, assign values to that space. Be sure that you understand how this differs from equated symbols, which are associated with values and expressions in the source-code text only. Variables have space reserved in the program's data segment in memory. Equated symbols do not.

The symbols associated with variables—`numRows`, `numColumns`, and `videoBase` in the previous samples—are called *labels*. A label points to the item that it labels—in this case the reserved memory space for a variable's value. Programs can refer to this space by using the label as a *pointer* to the value in memory. In the assembled program, labels are translated to the memory addresses where variables are stored, a process that allows you to address memory by the names you invent rather than by literal memory addresses.

NOTE

If you were programming directly in machine code, you would have to specify actual addresses instead of labels. One of assembly language's major advantages is the use of symbolic labels to identify locations in memory.

Variables are guaranteed to follow each other inside the data segment—knowledge that you can use to perform various tricks. For example, these declarations:

```
DATASEG
aToz    DB  "ABCDEFGHIJKLM"
nToz    DB  "NOPQRSTUVWXYZ"
```

seem to be creating two character strings labeled `aToz` and `nToz`. In memory, however, the characters A to Z are stored consecutively, creating one string containing the letters of the alphabet. The label `nToz` simply points to the middle of this string—there aren't really two separate entities in memory.

Careful readers may be thinking, "But wait! If `DB` means 'define byte,' what's it doing declaring character strings?" Good question. `DB` has the special ability to reserve space for multiple-byte values, from 1 to as many bytes as you need. A string is composed of individual ASCII characters, each occupying 1 byte; therefore, `DB` is simply assembly language's tool for declaring character strings, which, after all, are merely series of ASCII byte values stored consecutively in memory. You can use `DB` to declare individual characters and byte values, separated by commas:

```
DATASEG
perfectTen DB  1, 2, 3, 4, 5, 6, 7, 8, 9, 10
theTime    DB  9, 0      ; i.e., 9:00
theDate    DB  12,15,98  ; i.e., 12/15/1998
```

And, you can also combine character and byte values, creating a two-line string variable with the ASCII codes for carriage return and line feed stuck in between. As the following example shows, you can use either single or double quotes around character strings:

```
combo      DB  'Line #1', 13, 10, "Line #2"
```

Some languages—most notably Pascal—differentiate between single characters and strings of multiple characters. In assembly language, the difference between a character and a string is one of size only. There are no extra values, length bytes, or termination characters in assembly language strings, unless, of course, you put them there.

You'll learn more about strings later when examining assembly language instructions specially designed to manipulate byte strings in memory. For now, remember that, unlike in most high-level languages, strings are simply consecutive values in memory, created with the `DB` directive.

The Program Body

After the data segment comes the program's body, also known as the *code segment*—the memory chunk that contains your program's assembled code. Inside this area, assembly language text lines are further divided into four columns: *label*, *mnemonic*, *operand*, and *comment*. Each column has an important function, best described by example. In the program text, by the way, the amount of spacing between columns is not important. Most people align the columns by simply pressing their editor's tab key once or twice.

NOTE

If your editor allows you to choose between inserting tab control characters and inserting spaces, choose the tab controls and specify tab settings at every eighth column (the default in most editors). Inserting tab control characters makes it easy to keep columns aligned. Many times, with this arrangement, you can edit the text in one column without affecting another's alignment. If you prefer, though, you can insert spaces between columns. Turbo Assembler doesn't care.

Although you haven't met any actual assembly language instructions yet, examine the sample data and code segments in Figure 2.2 and try to pick out the four columns. (This is not a complete program—so don't bother trying to assemble it.) Although short and sweet, the example contains the essential elements of a complete assembly language code segment. To provide some data to use, a data segment also declares a single-byte variable named `exCode`, initialized to 0.

NOTE

In the first edition, many program listings used the identifier `EXITCODE`, which is replaced with `exCode` in this new edition. After the first edition was published, Turbo Assembler 3.0 and later versions reserved `EXITCODE` as a directive (see Chapter 17, “Turbo Assembler Reference”).

After the `CODESEG` directive in Figure 2.2 are several lines divided into label, mnemonic, operand, and comment columns. In the first column are two labels, `Start:` and `Exit:`. Labels mark the places in a program to which other instructions and directives refer. Lines that don't need labels have blanks in this column. In the code segment, a label always ends with a colon (:). In the data segment, a label must not end with a colon. (See the `exCode` label, for example.) You just have to memorize this rule, which admittedly makes little logical sense.

In the second column are mnemonics, literally “formulas for remembering things.” (By the way, the word “mnemonic” has a fascinating history. In Greek mythology, Mnemosyne—pronounced nee-moſ-in-nee—is the goddess of memory, the bride of Zeus, and the mother of the Muses. While trying to memorize assembly language mnemonics, a silent offering to Mnemosyne may not help, but it can't hurt.) Each mnemonic formula in the second column in Figure 2.2 refers to one machine-code instruction—`mov` for Move, `jmp` for Jump, and `int` for Interrupt. Some mnemonics are easy to remember: `dec` for Decrement, `shl` for Shift Left, and `ror` for Rotate Right. Others look like the handiwork of a crazed typesetter: `jcxz` for Jump if `cx` is Zero, and `rcr` for Rotate through Carry Right. A few rare cases are actually full-blown words: `out` for Out, `push` for Push, and `pop` for Pop. Even so, as you can clearly see, assembly language is abbreviated to the extreme. It will take time and patience to learn the name and purpose of each mnemonic. You'll meet the full set of 8086 mnemonics in Chapter 4. Also, Chapter 16, the Assembly Language Reference Guide, lists every mnemonic along with full names and descriptions of how the associated instructions operate. Refer to these sections often and memorize as many mnemonics as you can. When reading through a program, always pronounce a mnemonic's full name. In time, this will help make assembly language, if not easy reading, at least more understandable.

The third column in Figure 2.2 contains the operands—the values on which the preceding mnemonic instruction operates. A few instructions require no operands and, in these cases, the third column is blank. Many instructions require two operands; others take only one. No 8086 instruction requires more than two operands. The first operand is usually called the *destination*. The second operand (if there is one) is called the *source*. Operands take many forms; therefore, it's best to learn the different forms as you meet each mnemonic instruction.

Label	Mnemonic	Operand	Comment
	DATASEG		
exCode	DB	0	; A byte variable
	CODESEG		
Start:	mov	ax, @data	; Initialize DS to address
	mov	ds, ax	; of data segment
	jmp	Exit	; Jump to Exit label
	mov	cx, 10	; This line is skipped!
Exit:			
	mov	ah, 04Ch	; DOS funtion: Exit program
	mov	al, [exCode]	; Return exit code value
	int	21h	; Call DOS. Terminate program
	END	Start	; End of program / entry point

Figure 2.2. *The four columns of an assembly language program.*

The fourth and final column is always optional and, if included, must start with a semicolon (;). Turbo Assembler ignores everything from the semicolon to the end of the line, giving you a place to write a short comment describing what this line does. Nearly every line of every example program in this book ends with a comment, which you can leave blank to save typing time if you are entering the programs by hand. In your own work, be sure to add clear comments that fully describe your program. As you are no doubt beginning to realize, especially if assembly language is new to you, this language is cryptic and hard to read. You can't add too many comments.

A Few Comments on Comments

Sometimes you'll see an assembly language line that begins with a semicolon in the first column. Most programmers write their more lengthy comments this way, identifying various program sections and describing tricky sections. (As with comments at the ends of lines, you can leave these longer comments blank to save typing time when entering this book's examples.) Many programmers begin their programs with a multiline identifying comment like this:

```

-----
;
; PURPOSE: Predict winning Lottery numbers
; SYSTEM: IBM PC / Turbo Assembler Ideal Mode
; AUTHOR: Ivan the UnLucky
-----
;

```

Another kind of comment exists in MASM mode but, unfortunately, not in Ideal mode. In MASM mode, you can start a large comment with the `COMMENT` directive, followed by a character called the *comment delimiter*, in turn followed by your comment, and ending with a

2

second instance of the same delimiter. To do this in Ideal mode, temporarily switch to MASM mode:

```
MASM
```

```
COMMENT /* This is a comment, which can  
stretch over several lines and which you  
can easily reformat with your editor's  
paragraph command. */
```

```
IDEAL
```

After the MASM directive enables MASM mode, the COMMENT directive begins a multiline comment, defining a backslash as the comment delimiter character. A second backslash ends the comment. (The asterisks are purely for show here—I use them only to help my eye pick out comments in the text and to make the comments resemble those in C.) Finally, the IDEAL directive returns Turbo Assembler to Ideal mode. The blank lines after MASM and before IDEAL let me reformat the entire comment block using my editor's reformat-paragraph command, making it easier to edit a lengthy note in the program text. You may want to try this trick if your editor has a similar command.

The Closing

The final part of an assembly language program is the closing, a single line that tells Turbo Assembler it has reached the end of the program. There is only one directive in the closing: END. Repeating the last line from Figure 2.2, a typical closing is:

```
END      Start          ; End of program / entry point
```

The END directive marks the end of the program source-code text. The assembler ignores any text below this line—a good place to stick additional notes, by the way. To the right of END, you must specify the label where you want the program to begin running. Usually, this label should be the same as the label that precedes the first instruction following the CODESEG directive. You can start a program elsewhere, although I can't think of any good reasons for doing so.

Assembling a Program

Now that you know the form of an assembly language program, the next step is to learn how to assemble a program text file to produce a running code file on disk. Use your text editor to type in Listing 2.1, FF.ASM, or locate that file on disk. (Remember: Don't type the reference numbers and colons at the left. Type only the text to the right of the colons.) Try to align the four columns similarly to the printed text. You don't have to be too exacting—

close is good enough. To save time, leave out the comments. Quit your editor (or temporarily return to DOS if your editor has such a command) and type these lines:

```
tasm ff
tlink ff
```

The `tasm` command runs Turbo Assembler, which reads `FF.ASM` and, provided you entered the program text correctly, creates a new file `FF.OBJ`, containing the assembled code in raw form—not yet ready to run. If you receive any errors, check your typing and try again. The `tlink` command runs Turbo Linker, which reads `FF.OBJ` and creates the executable code file `FF.EXE`. Notice that neither command requires you to type the filename extension (`.ASM` or `.OBJ`). You can type these extensions if you want, but why work harder than necessary?

Now turn on your printer. (If you don't have a printer, you can't use this program. Sorry!) Type `FF` at the DOS prompt and press Enter to send a form-feed command to the printer, advancing the paper to the next page. Copy `FF.EXE` to the directory where you store your other utilities and run this program instead of reaching for your printer's form-feed button. (My printer is across the room, and I originally wrote `FF` years ago so I wouldn't have to get out of my chair just to advance the paper. So call me lazy.)

Listing 2.1. FF.ASM.

```
1: %TITLE "Send printer form feed command -- by Tom Swan"
2:
3:     IDEAL
4:
5:     MODEL    small
6:     STACK   256
7:
8: ;----- Equates
9:
10: ASCIIcr      EQU    13      ; ASCII carriage return
11: ASCIIff      EQU    12      ; ASCII form feed control code
12:
13:     CODESEG
14:
15: Start:
16:     mov     ax, @data      ; Initialize DS to address
17:     mov     ds, ax        ; of data segment
18:
19:     mov     dl, ASCIIcr    ; Assign cr code to dl
20:     mov     ah, 05h        ; DOS function: Printer output
21:     int     21h           ; Call DOS--carriage return
22:
23:     mov     dl, ASCIIff    ; Assign ff code to dl
24:     mov     ah, 05h        ; DOS function: Printer output
25:     int     21h           ; Call DOS--form feed
26:
27: Exit:
28:     mov     ax, 04C00h     ; DOS function: Exit program
29:     int     21h           ; Call DOS.  Terminate program
30:
31:     END     Start        ; End of program / entry point
```

NOTE

I have received reports from some readers that FF.EXE doesn't advance their printer. The program works fine for me and my trusty Epson FX-1050 dot-matrix printer, but there could be several reasons for FF.EXE not working on other systems. For example, your printer's form feed command might be disabled by a DIP-switch setting, or you might have a sheet-fed printer such as a laser or bubblejet that, to conserve paper, ignores form feed requests for blank pages. FF.EXE is not a "device-independent" program—it merely demonstrates how to send a byte to an output port, in this case ASCII 12, to the printer device. If your printer doesn't understand that byte as a form-feed command, then FF.EXE won't work for you. Such is the nature of assembly language programming.

Understanding Object Code

Listing 2.1 requires two steps—*assembling* and *linking*—to translate an assembly language program from text form into an executable program. Turbo Assembler never directly creates a program in ready-to-run form but instead generates an intermediate file containing the assembled program in a form called the *object code*. Before you can run the program, you must further process the object code with a linker, which creates the executable .EXE file on disk.

For simple programs, this may seem like two steps too many, but there is a good reason for dividing the process into assembly and link steps. As you will learn in later chapters, Turbo Linker (as well as other linkers) can combine multiple object-code files to produce a single executable program. This ability lets you program a large project in small pieces, assemble the pieces to create separate object-code files, and then link all the pieces with one command. The individual pieces, or modules, can share data and call subroutines declared in other modules. Most programmers build libraries of assembled object-code modules, collecting their favorite and well-tested building blocks, ready for constructing new programs. For some strange reason, in many high-level languages, writing programs in separate pieces this way is difficult and requires unusual commands and other incantations to get the job done. Luckily, as you will see, linking separately assembled object-code modules created by Turbo Assembler is easy.

Inside the object-code file are the machine-code instructions, translated from your assembly language text. Also in the object code are various text symbols that you want to share with other modules, plus optional information that Turbo Debugger requires. It's not necessary to understand every last detail of what's inside an object-code file. Just be aware that Turbo Assembler creates this file, always ending in .OBJ, and never directly creates the finished executable code. Only Turbo Linker can do that.

By the way, Turbo Assembler's object-code files end in the standard .OBJ, and you can link these files with other linkers (such as the one supplied with some early versions of DOS) and with object-code files produced by languages from other companies (for example, Microsoft C). You can, of course, link Turbo Assembler's object-code files with those produced by other Turbo Languages. Always use Turbo Linker for this purpose.

NOTE

In the future, carefully read your User's Guide and README file on disk for notes concerning compatibility between Turbo Linker and other linkers. Object-code file formats are constantly evolving, and anything I say here may be out of date six months from now.

Command-Line Options

Both Turbo Assembler and Turbo Linker allow you to specify options on the command line to select various features during assembling and linking. Type `tasm` and press Enter to list Turbo Assembler's command-line options. Type `tlink` and press Enter to list Turbo Linker's command-line options.

Options are represented by one or more letters, sometimes followed by other information. To select an option, type a dash and the option letter or letters between the `tasm` or `tlink` commands and the filename of the program you are assembling or linking. For example, to assemble Listing 2.1 and create a listing file, use the command:

```
tasm -l ff
```

You can type this and all other command lines in uppercase or lowercase. You can also use a forward slash instead of a dash if you prefer. The option `-l` tells Turbo Assembler to generate a listing file in addition to assembling the program, creating both `FF.OBJ` and `FF.LST` on disk. Try this command and then examine `FF.LST` with your text editor. Inside, you'll find a complete listing of the program along with line numbers, the object-code bytes, and, at the end, a listing of the program's symbols. You might want to print a copy of this file for reference.

NOTE

Don't create a listing file every time you assemble a program—this can slow even the speedy Turbo Assembler to a crawl. Most programmers create and print a listing file only after finishing a program or, sometimes, when a problem develops and they want to examine the object code that the assembler creates.

```

1                                     IDEAL
2 0000                                MODEL    small
3 0000                                STACK   256
4
5      = 13                            ASCIIcr EQU    13
6      = 12                            ASCIIff EQU   12
7
8 0100                                CODESEG
9
10 0000                                Start:
11 0000 B8 0000s                       mov     ax,@data
12 0003 8E D8                           mov     ds,ax
13
14 0005 B2 0D                           mov     dl,ASCIIcr
15 0007 B4 05                           mov     ah,05h
16 0009 CD 21                           int     21h
17
18 000B B2 0C                           mov     dl,ASCIIff
19 000D B4 05                           mov     ah,05h
20 000F CD 21                           int     21h
21
22 0011                                Exit:
23 0011 B8 4C00                       mov     ax,04C00h
24 0014 CD 21                           int     21h
25
26                                     END      Start

```

□ Turbo Assembler
Symbol Table

Version 5.3

05-13-02 15:53:37

Page 2

Symbol Name	Type	Value
??DATE	Text	"05-13-02"
??FILENAME	Text	"ff"
??TIME	Text	"15:53:37"
??VERSION	Number	0503
@32BIT	Text	0
@CODE	Text	_TEXT
@CODESIZE	Text	0
@CPU	Text	0101H
@CURSEG	Text	_TEXT

```

@DATA      Ff.lst      Text      DGROUP
@DATASIZE  Text      0
@FILENAME  Text      FF
@INTERFACE Text      000H
@MODEL     Text      2
@STACK     Text      DGROUP
@WORDSIZE  Text      2
ASCIICR   Text      13
ASCIIF    Text      12
EXIT      Near16   _TEXT:0011
START     Near16   _TEXT:0000

```

Groups & Segments	Bit	Size	Align	Combine	Class
DGROUP					
STACK	16	0100	Para	Stack	STACK
_DATA	16	0000	Word	Public	DATA
_TEXT	16	0016	Word	Public	CODE



Turbo Assembler Version 5.3 Copyright (c) 1988, 2000 Inprise Corporation

Syntax: TASM [options] source [,object] [,listing] [,xref]

/a,/s Alphabetic or Source-code segment ordering
/c Generate cross-reference in listing
 SYM[=VAL] Define symbol SYM = 0, or = value VAL
 .,./r Emulated or Real floating-point instructions
/h,/? Display this help screen
/iPATH Search PATH for include files
/jCMD Jam in an assembler directive CMD (eg. /jIDEAL)
/kh# Hash table capacity # symbols
/l,/la Generate listing: l=normal listing, la=expanded listing
/ml,/mx,/mu Case sensitivity on symbols: ml=all, mx=globals, mu=none
/mv# Set maximum valid length for symbols
/m# Allow # multiple passes to resolve forward references
/n Suppress symbol tables in listing
/os,/o,/op,/oi Object code: standard, standard w/overlays, Phar Lap, IBM
/p Check for code segment overrides in protected mode
/q Suppress OBJ records not needed for linking
/t Suppress messages if successful assembly
/uxxxx Set version emulation, version xxxx
/w0,/w1,/w2 Set warning level: w0=none, w1=w2=warnings on
/w-xxx,/w+xxx Disable (-) or enable (+) warning xxx
/x Include false conditionals in listing
/z Display source line with error message
/zi,/zd,/zn Debug info: zi=full, zd=line numbers only, zn=none

When assembling a program, you can string multiple command-line letters together, optionally separated by spaces. Here are a few more samples:

```
tasm /h
tasm -l-c ff
tasm /l /c ff
tasm -zi ff
tasm -l -iC:\INCLUDES ff
```

Try these on your system. Instead of assembling a program, the first command tells Turbo Assembler to display a list of command-line options. For a printed reference, type **tasm /h >prn**. The second line creates a listing file with cross-referenced line numbers (#10, #25, etc.) at the end. The third command does the same but shows how to use slashes instead of dashes to specify the option letters. The fourth line adds to FF.OBJ information for Turbo Debugger. The last line creates a listing file and specifies a path name for include files. (Include files are separate text files that you want Turbo Assembler to insert into your program. Listing 2.1 doesn't use any include files; therefore, this sample command has no practical effect.)

Turbo Linker also has various command-line options given in the same way, except that some early versions of TLINK require options to be preceded with a slash (/m) rather than a dash (-m). Newer versions of the linker allow slashes or dashes, but when typing multiple letter commands, dashes might have to be separated by a space. Here are several examples of Turbo Linker command-line options (I tested these with Turbo Linker 6.00; if you have a different version, try these commands to find out which option styles work on your system):

```
tlink -v ff
tlink /v ff
tlink -m -l ff
tlink /m/l ff
tlink -x ff
tlink /x ff
```

The first lines give the /v or -v option to prepare FF.EXE for use with Turbo Debugger. The next lines specify two options, selecting an extended map file (saved to FF.MAP on disk) and adding to this file additional line number information (/l). After trying this command, examine FF.MAP with your text editor. The /x or -x option tells Turbo Linker not to create a map file, saving a small amount of disk space and a tiny bit of time during linking. Use this command if you don't need the map file, which shows the memory organization of the program and is generally used by debuggers and as part of a program's documentation.

Dealing with Errors

If to err is human, programmers must be superhuman beings. No matter how careful we are, no matter how diligent, we all make plenty of mistakes in our day-to-day work. But you

can't fool Turbo Assembler. At least, you can't force the assembler to accept an illegal construction. If you try—whether intentionally or not—you'll receive an error message, a warning, or both. The distinction between errors and warnings is important:

- Errors are fatal. The resulting object code—if created—will not link and will not run.
- Warnings are not fatal. The resulting object code probably will link but may or may not run correctly.

Let's make a few intentional errors now so you'll know how to deal with your own mistakes later on. If you're using an editor such as Brief that can automatically run Turbo Assembler, press the Alt-F10 keys to assemble the next few examples. The error message will then appear at the bottom of your screen, and the cursor will rest on the offending line. If you are assembling by typing commands at the DOS prompt, you'll have to reload the program text, fix the error, exit to DOS, and try again.

When it finds an error, Turbo Assembler displays an error message along with the line number in parentheses. Some programmers save these messages in a disk file or print them for reference, using commands such as:

```
tasm ff>err.txt      (save errors in err.txt)
tasm ff>prn         (save errors to printer)
```

Without the redirection symbol (>) and a filename, error messages appear on-screen. Unless the errors scrolled off-screen, you can still print a copy of the display by pressing your Shift and PrtScr keys. To experiment with errors, copy FF.ASM (Listing 2.1) to a new file, FF2.ASM. Then modify line 3 to read IDEA. (Remove the capital L.) At the DOS prompt, type **tasm ff2** to assemble. Because Turbo Assembler has no idea what an IDEA is, assembling the program produces:

```
Assembling file:  ff2.ASM
**Error** ff2.ASM(3) Illegal instruction
Error messages:   1
Warning messages: None
Passes:           1
Remaining memory: 375k
```

The error message after the "Assembling file ..." line tells you in which file the error occurred, shows the line number in parentheses, and gives a brief message about the error. If you need more help, look up the error message in the alphabetized list near the end of your Turbo Assembler Reference Guide. Changing IDEA back to IDEAL fixes the mistake. Do that and then make another error, deleting the colon from the Start label at line 15. Assembling this file produces:

```
Assembling file:  ff2.ASM
**Error** ff2.ASM(15) Illegal instruction
**Error** ff2.ASM(31) Undefined symbol: START
```



```
Error messages: 2
Warning messages: None
Passes: 1
Remaining memory: 375k
```

Although you've made only one mistake, Turbo Assembler displays two error messages, one at line 15 because of the missing colon, and another at line 31, which refers to the `Start` label. Because the first error makes the `start` label unrecognizable—labels in the code segment must end with colons, remember—the later reference also fails. This is an example of *error propagation*: one error causing others to occur or to propagate. In a large program, the little buggers can sometimes propagate all over the place. If this happens, and especially if you suddenly begin receiving errors in sections that previously assembled just fine, try fixing only the first couple of reported errors and reassemble. Often, the remaining errors will then be gone.

Returning to our mistake-ridden example, replace the colon at the end of line 15. Then, add to line 14 the two words `PROC DUMMY`. Don't worry what this means. I just want to show you something. Assembling the program now gives:

```
Assembling file: ff2.ASM
*Warning* ff2.ASM(31) Open procedure: DUMMY
Error messages: None
Warning messages: 1
Passes: 1
Remaining memory: 375k
```

Similar to an error message, a warning tells you something is wrong at a certain line. Notice that, in this case, the reported line number is 31, not 14 as you might have expected. A `PROC` directive specifies the start of a *procedure*, a group of instructions that your program treats as a complete routine. Turbo Assembler expects all `PROC` directives to have matching `ENDP` (End Procedure) directives. Because it finds no such directive by the time it reaches the end of the program, the assembler warns you that a procedure was left open somewhere.

Because this is a warning and not an error, you can link and run the resulting program. In this case, the nonexistent open procedure does no harm. In fact, there is no effect whatsoever on the resulting code. This may not always be true, however, and you are living dangerously if you ignore Turbo Assembler's warnings. For example, a missing `ENDP` may result from leaning on your text editor's delete-line key—or perhaps you accidentally left a procedure unfinished. Turbo Assembler is very forgiving of such errors, giving you the freedom in many cases to make gross mistakes—the price you pay for the low-level access and potential speed available only in pure assembly language. The assembler is smart enough to warn you about potential dangers, but intimate knowledge of your program is still the only way to know for certain whether a warning is significant or can be safely ignored.

NOTE

If you've been following along, you can delete your FF2.* test files now. You won't need them again.

Introducing Turbo Debugger

Although you can fix syntax errors by reading Turbo Assembler's error messages and then examining your text to find typos and illegal constructions, fixing logical errors is not so easy. Turbo Assembler knows how to assemble a syntactically correct program, but it doesn't understand what the program is supposed to do. Often, your programs will not do what you think they should. In this event, you can get some much-needed help from a program specifically designed to help you find and repair logical errors: Turbo Debugger.

Like all debuggers, Turbo Debugger serves as a kind of supervisor, taking control of a program and letting you examine variables in memory and run the code in slow motion. You can tell Turbo Debugger to run a program up to a certain point or until a certain event occurs. You can change values in memory, temporarily try out new instructions, and change register and flag values. You can also use Turbo Debugger to program in machine code, occasionally useful for trying out ideas as long as the number of instructions is not too large.

Such a versatile program is extremely helpful in assembly language programming, where a program's logic is difficult to discern from the program's text. Turbo Debugger can also help you find errors in C and Pascal programs, although we'll concentrate here on assembly language debugging. As I mentioned in Chapter 1, Turbo Debugger also makes an excellent teacher, giving you the opportunity to examine your program and observe the effects of various instructions. One of the best ways to learn about individual mnemonic instructions is to write a short test program, load the program into Turbo Debugger, and examine the results in slow motion. If you make the effort to do this every time you have a question about a certain instruction, you'll be amazed at the amount of information you'll pick up just by watching the instruction in action.

Debugging with an 80386 or Later Processor

If your system has an 80386, 80486, or Pentium processor, you can take advantage of special features in Turbo Debugger. If your system has an 8086, 8088, or 80286 processor, you can't use these special features. Even so, Turbo Debugger is a powerful program, having many commands that you can use to debug programs on any PC. If your system does have an 80386 or later-module CPU, insert the following command in your root directory's CONFIG.SYS file, specifying the correct path name to locate the TDH386.SYS device driver file:

```
DEVICE=\TDEBUG\TDH386.SYS
```

This enables Turbo Debugger to use special debugging registers available only inside the 80386 processor. These registers give Turbo Debugger the ability to stop a program when any bytes in a specified memory range are changed or even if these bytes are merely examined by a program. You can also run your program in virtual memory, exactly simulating how your program will run as a stand-alone DOS application. Without an 80386, your program necessarily shares memory with the debugger. As a result, some bugs—especially those that depend on the program's location in memory—may disappear under control of the debugger and then reappear when running the program normally, a tricky problem that can be difficult to fix.

With the device driver installed, you can use the virtual-memory version of Turbo Debugger TD386.EXE in place of the standard version TD.EXE. (You can still use the standard version.) Whenever this book tells you to type TD, type TD386 instead.

NOTE

The TDH386.SYS driver and TD386.EXE debugger are no longer needed with Turbo Assembler 4.0. The instructions in this section apply only to earlier versions of Turbo Assembler and Turbo Debugger.

Turbo Debugger as Teacher

To demonstrate how to use Turbo Debugger as an assembly language teacher, let's examine Listing 2.1 under control of the debugger. First, copy FF.ASM to LF.ASM and load the copy into your text editor. You may delete or rename LF.ASM if it exists on disk. Then change three lines as follows:

```
1: %TITLE "Send line feed command to printer"
11: ASCIIlf EQU 10 ; ASCII line feed control code
23: mov dl,ASCIIlf ; Assign lf code to dl
```

These modifications convert the form-feed program into a line-feed program, which you can use to advance your printer one line at a time. This may not be that useful a utility program to keep around, but these changes will save paper for the upcoming tests.

After saving LF.ASM, assemble and link the program with options that add debugging information to the .OBJ and .EXE files. This information tells Turbo Debugger about the program's symbols, locations of variables, segment organization, and so on. Type these commands to prepare the program for debugging:

```
tasm /zi lf
tlink /v lf
```

If you don't use the `/zi` and `/v` options as shown here, Turbo Debugger can still load your program, but the debugger will be able to show only the disassembled machine code. With the command-line options, the debugger can show labels, variable structures, source-code lines, and other information. In future example programs, whenever I suggest examining a program with the debugger, use these same options during assembly and linking.

NOTE

Using the `/zi` and `/v` options can greatly increase the size of a program's `.OBJ` and `.EXE` disk files. After debugging, reassemble and link without these options to shrink disk-file sizes back to normal.

After assembling and linking with the `/zi` and `/v` options, make sure you have at least the `LF.ASM` and `LF.EXE` files on disk and then load the program under Turbo Debugger's control with the command:

```
td lf
```

Remember: If you installed the `TDH386.SYS` device driver and have an 80386 processor in your system, you can use the virtual-memory version of Turbo Debugger by giving the alternate command:

```
td386 lf
```

In a moment, you should see Turbo Debugger's display, showing the program's source code. (If Turbo Debugger can't find the program's `.ASM` file, it will be unable to display the source-code window.) Use the cursor keys to move the flashing cursor up and down, examining the program text. You can also use the `PgUp`, `PgDn`, `Home`, and `End` keys to move around in the source-code window. You can only view this text; you can't edit any mistakes you may find. To do that, you have to quit Turbo Debugger and use your text editor.

NOTE

For more help, press `F1` (the help key) and read the window that pops up on-screen. At any time when using Turbo Debugger, you can get help on the current window by pressing `F1`.

For a different view of your program, press `Alt-V-C`, selecting the `View-CPU-Window` command. Press `F5` to toggle this window to full screen. The CPU window shows your program's source code in an abbreviated form, the actual machine code as stored in memory, the values

of registers and flags, and a dump of the memory bytes. Besides showing many more details, there's an important difference between this window and the previous one. In the source-code window, also called the *module view*, you are seeing a copy of the program text. In the CPU window, you are peering directly into memory, seeing the actual byte values that are there. The CPU window takes you on a kind of fantastic voyage, miniaturized in the style of an Isaac Asimov novel and injected into your computer's RAM. Naturally, when performing surgery on bytes in memory, you want to be careful not to kill the patient. Turbo Debugger helps prevent catastrophes, but you can still get into trouble by fooling around indiscriminately.

Press the cursor up and down keys to move the highlighted bar to different instructions. Diamonds mark the instructions that belong to your program. Notice that, unlike the source-code window, you can view other areas outside of these marked lines. Press the Tab key to move the cursor to other sections of the CPU window. You'll do this from time to time to change register values and to modify bytes in memory. (Don't change anything this time.)

Press the Tab key until the highlighted bar reappears in the large section. To change the appearance of this window, press Alt-F10 and select the Mixed command (press M or move the bar to Mixed and press Enter). You can give this same command more easily by pressing Ctrl-M, too. The command has three settings: No, Yes, and Both. The settings change the view of your program as follows:

- **No** shows a disassembly of the machine-code bytes in memory, looking similar to assembly language instructions. It is convenient for viewing code when you don't have the corresponding .ASM file. This view is less cluttered than the others, and, for that reason, many prefer it.
- **Yes** shows your source code along with the disassembled machine code. It is used to display high-level language lines along with the compiled machine code. Normally, you won't use this setting to view assembly language programs.
- **Both** is the default and probably the best view in the CPU window, showing the machine-code bytes in the left column along with the source-code lines that created the code. It doesn't display blank lines.

Besides showing you different views of your program and memory, Turbo Debugger can execute your code in various ways. For practice, turn on your printer (if you have one) and then follow these numbered steps to execute the program under Turbo Debugger's control:

1. Press F9 to run the program to completion. The paper should advance one line. Use this command to run a program and then examine the state of memory, registers, and flags after the program finishes.
2. After running the program, press Ctrl-F2 to reset. This reloads the program from disk, resetting Turbo Debugger to its original startup condition. (If you forget this step and press F9 to run again, you'll see a message asking if you want to reload the program.)

3. Press F6 twice to get back to the source-code window.
4. Press Alt-V-R to select the View-Registers command. If necessary, press Ctrl+F5 and use the arrow keys to move this window to the far right, or click and drag the window with a mouse, uncovering your program's instructions. Press Esc to lock the window in its new position. The registers window shows the values of the registers and flags inside your computer's processor. This window is extremely useful for examining the results of various machine-code instructions, most of which affect the values in one or more registers.
5. In the source-code window, a small arrow to the left of the program's first instruction, `mov ax, @data`, tells you that this is the next instruction to be executed. Press F8 to execute this instruction. When you do this, two things happen: The arrow moves down to the next instruction, and the value of the `ax` register in the registers window changes. The instruction "moved" a value into the register—you saw it happen. Stepping through individual instructions with F8 lets you run your program in slow motion, executing one instruction at a time and pausing to let you view the effects of each machine code.
6. Press F8 again, executing the next instruction, `mov ds, ax`. Watch the registers window—you should see the value of the `ds` register change to the same value now in `ax`. The `mov` instruction moved the value of `ax` into `ds`. Again, for the time being, don't be too concerned with why the program does this.
7. Press F6 until the flashing cursor reappears in the source-code window. The register window is now covered by this window. (F6 switches among all open windows—you can also press Alt-# where # is the window number 1-9.)
8. Move the flashing cursor down to the line that reads `mov d1, ASCII1f`—three instructions beyond the current instruction marked by the arrow. Press F4 to run the program from the current instruction down to the instruction at the flashing cursor. Use this method to execute small sections of code when you don't want to pause after each instruction.
9. Press F6 repeatedly until the registers window reappears. Then press F8 twice, executing the next two instructions. Watch the value of the `dx` register—you should see a part of this value change.
10. The arrow should now point to the `int 21h` instruction (at line 25 in Listing 2.1). This instruction calls a function in DOS, activating one of the operating system's many routines, in this case, sending a character to the printer. Press F8 to execute the instruction. If your printer is on, the paper should advance one line.
11. There's no need to run the program to completion as the remaining instructions simply return control to DOS—or, in this case, to Turbo Debugger. Press Alt-X to quit the debugger and end the session.

Turbo Debugger has many other commands to let you examine, execute, and modify your program. But the preceding steps are all you need to know to run most assembled examples in this book, and to examine the effects of various instructions. In future examples, I'll tell you how to use other Turbo Debugger commands. As you can see, a debugger can help you examine your program in ways that otherwise would be impossible. When it comes to helping you learn assembly language, Turbo Debugger is indeed a great teacher.

Writing .COM and .EXE Programs

You probably know that in DOS there are two kinds of executable code files: those that end in .COM and those that end in .EXE. You can write assembly language programs to create both types. Although most example programs in this book are of the .EXE variety, at times you may want to produce a .COM file instead.

NOTE

Microsoft has indicated its desire to kill the .COM file format, but it has so far been unsuccessful in the attempt. If you write your programs in this format, be aware that you may be making a lot of work for yourself in the future should Microsoft succeed in its effort banish .COM files from the face of the Earth.

Rather than start new programs from scratch, you may find it helpful to begin with a template containing the bare necessities required by .COM and .EXE programs. Listing 2.2 lists a shell for .COM programs. Listing 2.3 lists the corresponding .EXE shell. You can use the .EXE shell to save typing time when entering example programs in other chapters. Each template has several comments beginning with semicolons and suggesting where to place equates, variables, and other items, some of which will be new to you. You may remove these comments when starting a new program with a copy of one of the templates.

Listing 2.2. COMSHELL.ASM.

```
1: %TITLE "Shell for .COM files -- by Tom Swan"
2:
3:     IDEAL
4:
5:     MODEL    tiny
6:
7: ;----- Insert INCLUDE "filename" directives here
8:
9: ;----- Insert EQU and = equates here
10:
11:     DATASEG
12:
```

```

13: ;----- If an error occurs and the program should halt, store an
14: ;         appropriate error code in exCode and execute a JMP Exit
15: ;         instruction.
16:
17: exCode      DB      0
18:
19: ;----- Declare other variables with DB, DW, etc. here
20:
21:      CODESEG
22:
23:      ORG      100h      ; Standard .COM start address (origin)
24:
25: Start:
26:
27: ;----- Insert program, subroutine calls, etc., here
28:
29: Exit:
30:      mov     ah, 04Ch      ; DOS function: Exit program
31:      mov     al, [exCode] ; Return exit code value
32:      int     21h          ; Call DOS. Terminate program
33:
34:      END     Start      ; End of program / entry point

```

Listing 2.3. EXESHELL.ASM.

```

1: %TITLE "Shell for .EXE code files -- by Tom Swan"
2:
3:      IDEAL
4:
5:      MODEL  small
6:      STACK  256
7:
8: ;----- Insert INCLUDE "filename" directives here
9:
10: ;----- Insert EQU and = equates here
11:
12:      DATASEG
13:
14: ;----- If an error occurs and the program should halt, store an
15: ;         appropriate error code in exCode and execute a JMP Exit
16: ;         instruction. To do this from a submodule, declare the Exit
17: ;         label in an EXTRN directive.
18:
19: exCode      DB      0
20:
21: ;----- Declare other variables with DB, DW, etc. here
22:
23: ;----- Specify any EXTRN variables here
24:
25:      CODESEG
26:

```

continues

Listing 2.3. continued

```

27: ;----- Specify any EXTRN procedures here
28:
29: Start:
30:     mov     ax, @data      ; Initialize DS to address
31:     mov     ds, ax        ; of data segment
32:     mov     es, ax        ; Make es=ds
33:
34: ;----- Insert program, subroutine calls, etc., here
35:
36: Exit:
37:     mov     ah, 04Ch      ; DOS function: Exit program
38:     mov     al, [exCode]  ; Return exit code value
39:     int     21h          ; Call DOS. Terminate program
40:
41:     END     Start        ; End of program / entry point

```

Writing .COM Programs

Listing 2.2 shows the correct format for writing .COM programs in Ideal mode. Line 5 selects the tiny memory model, which combines the program's variables, code, and stack into one 64K memory segment. Because of this, .COM programs always occupy 64K of memory (or all available RAM, whichever is less), regardless of the program's size on disk. This little-known fact is one reason that .EXE programs are preferred. Although .EXE code files may take up more room on disk (because additional information about the program's organization is included in the file), most small .EXE programs take up much less memory during execution than the equivalent .COM programs.

Line 23 shows another characteristic of a .COM program. The `ORG` (origin) directive tells Turbo Assembler that this program's first instruction is to be loaded at address 100h (the small *h* stands for hexadecimal), relative to the beginning of the program's *code segment*—the chunk of memory designated to hold the assembled machine code. This value is the same as the load address for programs written for the CP/M operating system, upon which much of DOS is based and which usually ran on computers having a *total* memory size of 64K. Under DOS, .COM programs operate in a kind of pseudo-CP/M address space, despite the fact that most modern PCs have ten times the memory capacity (640K) or more. Today, there's almost no good reason to use this ancient code-file format.

In Chapter 4, you'll meet most 8086 instruction mnemonics; therefore, I won't explain here what Listing 2.2 does at lines 30-32. The effect of this code is to return control to DOS when the program is finished. All .COM programs must end with these instructions (or an equivalent variant).

Assembling .COM Programs

To assemble a .COM program requires slightly different commands than described earlier. You must pass Turbo Linker the /t option, which specifies a tiny model program. For practice, assemble and link Listing 2.2 with these commands:

```
tasm comshell  
tlink /t comshell
```

It Ain't Over Till ... Actually, It Ain't Ever Over

This is a good time to introduce a most important point: All assembly language programs must return control either to another program or to DOS, using commands specifically provided for this purpose. This concept frequently confuses programmers who have written programs in other languages like C, Pascal, and BASIC, where programs simply end. Assembly language programs never end—they just fade away—that is, they relinquish control to another running program.

You can understand the purpose behind this idea if you remember that the computer's processor is always processing. As long as the plug is in and the switch is on, there is never a time when a computer isn't computing. Even when the DOS prompt silently waits for your next command, the computer processor is whizzing away, performing billions of cycles, constantly processing the instructions that only appear to make the computer pause. Doing nothing takes a great deal of effort for a computer!

Because of the processor's incessant cycling, a program can never simply end—it has to hand over control to another program to give the processor something to do. Forgetting this step almost always has drastic results. If you fail to hand over control to another program, the processor will continue to process whatever is in memory after the physical end of your program. That memory might contain anything—leftover code and data from other programs or just the random bit patterns that exist when you switch on power. The result of processing this unknown information is usually a spectacular crash, garbage on-screen, or worse, the permanent destruction of data on disk. Use the templates in Programs 2.2 and 2.3, which include the necessary instructions to return control to DOS. That way, you won't accidentally forget this important step.

When most programs end, they give DOS a command to reload a program called COMMAND.COM, located on your boot disk or in a hard drive's root directory, usually C:\. COMMAND.COM is a program just like any other but with the special purpose of letting you give commands to DOS. When you run a program from DOS, COMMAND.COM loads your code and passes control to your program's instructions. When your program ends, it must return control to COMMAND.COM for the DOS prompt to reappear. Be sure you understand this process—it is vital to your ability to write assembly language programs.

Writing .EXE Programs

Writing a program in .EXE format takes a little more work than writing .COM programs, but the result is usually worth the effort. The .EXE format occupies only as much memory as required to run your program, leaving the most room possible for storing data, creating large arrays, and sharing space with other .EXE programs in a multitasking operating system. (DOS does not have multitasking abilities—that is, the ability to run two or more programs simultaneously, although you can add this ability to DOS by running Microsoft Windows. Writing programs in .EXE format lets these programs organize memory more efficiently.)

The reason that .EXE programs require more work is that variables, the stack, and the machine code are stored in separate memory segments, occupying up to a total of 128K under the small memory model. (The small memory model combines the stack and data segments; other models allow larger amounts of code and data.) In Listing 2.3, the size of the stack is specified by the `STACK` directive (line 6). The size of the data segment is calculated from the combined sizes of the program's variables. The size of the code segment depends on how many instructions are in your program.

Because variables are stored apart from the program's code—unlike in the .COM format, where data and code share the same memory segment—the first job in all .EXE programs is to initialize the data segment register `ds`. Lines 30-31 accomplish this task in Listing 2.3, assigning the built-in symbol `@data` to register `ax` (line 30) and then assigning `ax` to `ds` (line 31). The reason this takes two steps is that you cannot assign values like `@data` directly to segment registers—you can assign values only from other general-purpose registers such as `ax`.

Ending an .EXE program is identical to ending a .COM program, as lines 37-39 show. Again, don't be too concerned here with what these instructions do. Remember, though, that the purpose is to pass control back to `COMMAND.COM`, using a special DOS function. To assemble and link Listing 2.3, use these commands.

```
tasm exeshell
tlink exeshell
```

Printing Listings

Now that you know how to enter, assemble, and link programs, you may want to print reference listings of the sample programs in this chapter. Because assembly language listings tend to produce lines longer than the standard 80-character width of most printers, the first step is to write a program to select your printer's compressed style, usually extending the limits a 132-character lines and, on some printers, even more.

Listing 2.4, PR132.ASM, is a simple .EXE style program that selects 132-character output on most Epson-compatible printers. Assemble and link the program with these commands:

```
tasm pr132
tlink pr132
```

Listing 2.4. PR132.ASM.

```
1: %TITLE "Select 132-char printer output -- by Tom Swan"
2:
3:     IDEAL
4:
5:     MODEL    small
6:     STACK    256
7:
8:     DATASEG
9:
10: ; Insert the codes that select your printer's 132-character (or
11: ; greater) output style, sometimes called "compressed" mode.
12: ; The values below should work with most Epson-compatible printers.
13: ; The last value must be 0!
14:
15: prCodes      DB      27, 15, 0    ; Must end in 0!
16:
17:     CODESEG
18:
19: Start:
20:     mov     ax, @data      ; Initialize DS to address
21:     mov     ds, ax        ; of data segment
22:
23:     cld                    ; Clear df--auto increment si
24:     mov     si, offset prCodes ; Point si to prCodes
25: Next:
26:     lodsb                   ; Load next code into al
27:     or      al, al          ; Is al = 0?
28:     jz     Exit            ; If yes, jump to exit
29:     mov     dl, al         ; else assign al to dl
30:     mov     ah, 05h        ; DOS print char function
31:     int    21h            ; Call DOS. Print char.
32:     jmp    Next           ; Do next code.
33: Exit:
34:     mov     ax, 04C00h     ; DOS function: Exit program
35:     int    21h            ; Call DOS. Terminate program
36:
37:     END     Start         ; End of program / entry point
```

After assembling PR132.ASM, try an experiment. Turn on your printer and type **DIR>PRN** to print a listing of the current directory in your printer's default style. Type **PR132** and press Enter. Then, type **DIR>PRN** again, this time printing a directory in compressed style. If this doesn't work, you'll probably have to modify the codes in line 15 for your printer. Check your manual for the correct values to use. After the DB directive, you can specify codes in

decimal, hexadecimal (start the value with 0 and end with h), or characters (surround one or more characters with double or single quotes). Some printer manuals list hexadecimal codes with preceding dollar signs, as in \$1F. Rewrite such codes in assembly language style: 01Fh. For example, if your printer specifies the sequence Escape-C, \$1F, you could use any one of the following lines in place of line 15:

```
prCodes DB 27, 67, 31, 0 ; decimal
prCodes DB 01Bh, 043h, 01Fh, 0 ; hexadecimal
prCodes DB 27, 'C', 01Fh, 0 ; decimal, char, hex
```

The last value must be 0, marking the end of the sequence. This format—a list of bytes ending with 0—is a typical construction in assembly language programs, allowing the list to contain any number of items—as long as no other value is 0, of course.

Unless you've written programs in assembly language before, you probably won't understand the instructions in PR132.ASM. This is not too important. The purpose of this chapter is to get you started, giving you practice entering, assembling, and linking programs—valuable experience that you will draw upon later. Even so, you should at least be able to understand the idea of this program by reading the comments. The plan is simple: get each of the `prCodes` bytes in turn and send each value to the printer until reaching the 0 byte, marking the end of the list. Then, return control to DOS.

Listing PR132

After entering PR132.ASM, assembling, linking, and testing, you're ready to print a reference listing. Turn on your printer and type **PR132** to select compressed output. Then reassemble the program, this time using the command:

```
tasm /l PR132
```

As an alternative, to include a cross-reference of symbols at the end of the listing, use the command:

```
tasm /l/c PR132
```

Either of these commands creates PR132.LST, called the *listing file*, ready to print. To print the listing file, type the command:

```
type pr132.lst>prn
```

The listing file contains form-feed control characters to skip page perforations, and for this reason, you probably shouldn't print listing files with a word processor, as these programs usually handle paging automatically. You might also send the listing to a print spooler, allowing you to run other programs while printing continues. Unless you are logged onto a network, use the DOS command to spool a listing file:

```
print pr132.asm
```

If this is the first time you gave a print command, you'll be asked to supply an output file. Usually, just press Enter to select the default file PRN. Refer to your DOS manual for more information about using the print spooler. You can print multiple listings by separating their names with spaces on the command line—a real time saver if you need to print several listing files and want to continue editing and assembling other programs. You can print multiple files by separating their names with spaces or by giving separate print commands. Assembly language listings tend to be much longer than those produced by high-level languages, and a print spooler is a practical necessity for assembly language programmers.

After printing, copy your listing files to a floppy disk along with the other files related to each program. Most people save the listing files for future reference. If you're tight on space, you can delete the files ending in .LST.

NOTE

Because the `*TITLE` directive line is not included in the listing file, the line numbers printed in this book do not match the line numbers in a printed listing. Line 3 in the book is line 2 in the listing, and so on. To refer to your own printed listings while reading this book, subtract 1 from line number references. (In other words, if I say "see line 20," refer to your listing file line 19.)

Summary

Assembly language programs roughly divide into five sections: header, equates, data, body, and closing. The body is further divided into four columns: labels, mnemonics, operands, and comments. Labels refer to the positions of variables and instructions, represented by mnemonics. Operands are required by most assembly language instructions, giving instructions data to process. Comments, always optional, help you to remember the purpose of various instructions.

Assembling programs produces object code, which must be linked to create an executable file, ending either in `.EXE` or `.COM`. You can use special option letters to select features in Turbo Assembler and Turbo Linker. Turbo Assembler reports errors and warnings on-screen during assembly.

Turbo Debugger can run an assembled program in slow motion and can let you peer into memory to see the actual bytes that form your program's code and data. You can use Turbo Debugger to help pinpoint bugs and also as your personal assembly language teacher, which can run test programs and let you observe the effects of executing individual machine-code instructions.

The .COM code file format is a carry-over from the CP/M operating system. While useful in some cases, this format is not recommended for PC programs. All code, data, and the stack in a .COM program occupy one 64K memory segment. The .EXE code-file format is more efficient, even though programs may occupy slightly more room on disk. In memory, .EXE programs occupy only as much memory as needed. Writing .EXE programs takes a little more effort because you are responsible for specifying a program's data, code, and stack segments.

Assembly language programs don't end—they pass control to another program, usually COMMAND.COM. Forgetting this step can cause serious problems by executing random instructions in memory following the physical end of your program.

A listing file documents a program. Most programmers print listing files of their finished programs for future reference. You can use the DOS print spooler to print long listings while you continue working.

Exercises

- 2.1. Referring to Listing 2.3, what are the line numbers of the header, equates, data, body, and closing?
- 2.2. What is the name of the variable in Listing 2.4?
- 2.3. How many comments are there in Listing 2.1?
- 2.4. What characters precede option letters for Turbo Assembler and Turbo Linker?
- 2.5. Suppose you have a program text file named BUGABOO.ASM. What are the assembling and linking steps required to create the necessary files to debug BUGABOO with Turbo Debugger?
- 2.6. Which program do you use, Turbo Assembler or Turbo Linker, to create object code? Which do you use to create executable code? What is the purpose of creating object code?
- 2.7. What is the difference between an error and a warning? What should you do if you receive an error or a warning?
- 2.8. How do .COM and .EXE code files differ?
- 2.9. Suppose you have a program named LISTME.ASM. What are the steps required to assemble and print a listing file of this program.
- 2.10. What is the correct way to end an assembly language program?
- 2.11. What does the DB directive do? What kinds of data can you create with DB?

Projects

- 2.1. Print a reference copy of Turbo Assembler's option letters.
- 2.2. Make a copy of Listing 2.4 and rename the copy PR80.ASM. Modify this program to select your printer's 80-column output style.
- 2.3. Create and print listing files for Programs 2.1 through 2.4.
- 2.4. Start a floppy disk or hard drive directory for saving your assembled example programs. Create individual subdirectories for each program, naming the directories the same as the programs. Then copy all files for each program to the appropriate subdirectory. For example, to save Listing 2.1, you could create a subdirectory named FF and copy to FF the files: FF.ASM, FF.OBJ, FF.EXE, FF.MAP, and optionally FF.LST.
- 2.5. Execute Listing 2.4 under control of Turbo Debugger. Press the F8 key to run the program a single step at a time. Watch carefully the repetitive action of the instructions from line 26 through 32 as the program reads each printer code until reaching the 0, marking the end of the list. Bring up the register window and watch the ax register, especially for the instruction at line 26. What do you think is happening here?
- 2.6. Rewrite Listing 2.1 and assemble to a .COM code file.

3

CHAPTER

A Bit of Binary

- Memorabilia, 54
- How Many Bits in a Byte?, 55
- Binary Arithmetic and Logic, 56
- Counting in Binary, 56
- Binary and Hexadecimal, 59
- Two's Complement Notation, 61
- Logical Operators, 65
- Shifting and Rotating, 69
- Summary, 70
- Exercises, 71
- Projects, 72

Memorabilia

Bits and bytes are an assembly language program's fuel. The more you know about bits, bytes, and the arithmetic and logic operations you can perform on binary values, the more energy you'll be able to squeeze from this power source of all digital computing—the lowly binary digits, or *bits*, 0 and 1.

Physically, of course, there are no binary digits in memory or in the computer's processor—there are only electric charges that are on (energized) or off (not energized). For the purposes of programming, however, it's convenient to ignore this fact and pretend that there are indeed ones and zeros stuffed into the computer's circuit board. Groups of binary digits can then represent values, which in turn can stand for all sorts of items: ASCII characters, printer control codes, checkbook balances, the date and time, and so on. Other binary values might be used to read and write values to input and output ports, which appear to programs like other values in memory but which might actually be switches that activate and deactivate various circuits that control devices attached to the computer. Storing bits to these locations is equivalent to flipping a light switch on and off. In assembly language, simply writing a certain value to a specific location can turn on motors, display characters, send values to remote systems, and make sounds.

With such an important role for binary values to play—especially in assembly language programming—it's important to be intimately comfortable with binary arithmetic and logic. That doesn't mean you have to be able to add columns of hexadecimal numbers by hand. For this, you may as well use a programmer's calculator. (After all, that's what most professional programmers do.) Even so, a working knowledge of binary principals is vital to your ability to write good assembly language programs. By all means, use your calculator, but don't ignore learning the basics. Every minute you spend learning these subjects will save you from hours of puzzlement in the future.

NOTE

Because a good understanding of binary arithmetic and logic operations is so important to assembly language programming, this chapter reviews the fundamentals from the beginning. If you know your way around the binary number system, you may want to skim this material (and look for more advanced tips near the end).

How Many Bits in a Byte?

Let's start with a quick review. There are 8 bits in a byte; 2 bytes in a word; 4 bytes in a doubleword; 6 bytes in a farword; and 8 bytes in a quadword. Bits are numbered from right to left—bit 0 is always farthest to the right and is called the *least significant digit* (LSD). The bit farthest to the left is called the *most significant digit* (MSD). Figure 3.1 illustrates typical ways of representing the bits in byte and word values.

Figure 3.1.
Typical byte and word diagrams.

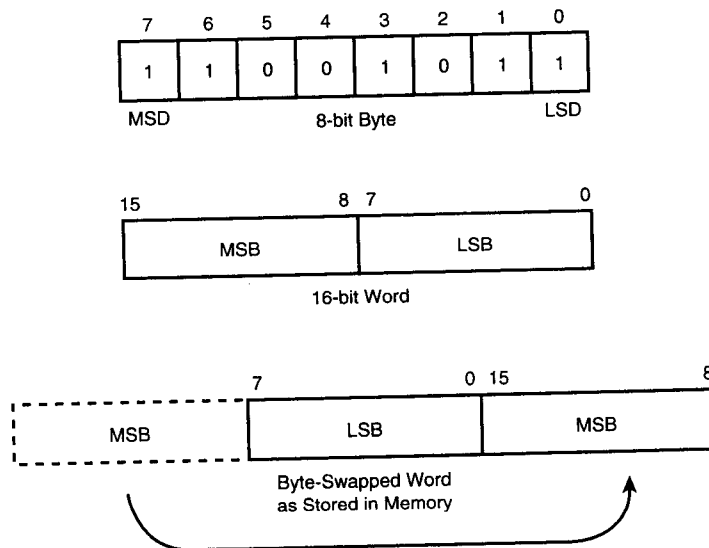

In memory, bytes are stored consecutively one after the other. Each byte has an associated address, a unique number that pinpoints this byte's location from all others. To read and change byte values in memory, assembly language programs specify a value's starting address, usually but not always in the form of a named label such as `temperature` or `numCumquats`. Being able to use readable labels instead of actual address values like `0F00:0014` is one of the main advantages offered by assembly language.

In 8086 programming, word values are stored in byte-swapped order, with the word's *most significant byte* (MSB) at a higher address than the *least significant byte* (LSB). In assembly language listings, word values are shown in reverse order from the order that the bytes are actually stored in memory. (For example, see Figure 3.1, bottom.) This byte-swapped order

makes arithmetic easier to perform on multibyte values because the least significant bytes, which must be added first, are at lower addresses. But the swapped order can also lead to confusion for people who have to read the listings and relate printed values to those in memory. To locate a word in memory equal to hexadecimal 0201, for example, requires searching for the two consecutive bytes, 01 and 02, not for 02 and 01.

Binary Arithmetic and Logic

Because large values can take many bits to represent, calculating complex equations directly in binary is tedious. Fortunately, you don't need to become so fluent in binary arithmetic that you can instantly convert a grocery cash register tape from decimal to binary, compute the sum, and convert back to decimal all in your head. Some books require you to learn how to add, subtract, multiply, and divide directly in binary—operations that programmers in the real world would rather do on a computer. My hat's off to you if you find such operations easy. For most purposes, the well-versed assembly language programmer needs to know how to perform only four fundamental operations:

- Count from 0 to 16 in binary without help.
- Convert values into binary, hexadecimal, and decimal.
- Understand the logical operations AND, OR, and XOR.
- Understand how signed (positive and negative) and unsigned (positive only) values differ in their binary representations.

Counting in Binary

Table 3.1 lists the binary, hexadecimal, and decimal values from 0 to 16. Try to memorize this table and mark this page. You'll need these values time and again.

Table 3.1. 0-16 in Binary, Hexadecimal, and Decimal.

<i>Binary</i>	<i>Hexadecimal</i>	<i>Decimal</i>
0000	00	0
0001	01	1
0010	02	2
0011	03	3
0100	04	4
0101	05	5
0110	06	6
0111	07	7

<i>Binary</i>	<i>Hexadecimal</i>	<i>Decimal</i>
1000	08	8
1001	09	9
1010	0A	10
1011	0B	11
1100	0C	12
1101	0D	13
1110	0E	14
1111	0F	15
1 0000	10	16

It's easy to learn how to count and add in binary if you remember one simple fact about adding two values expressed in any number system: When you run out of symbols in a column, carry a 1 to the left. You know how to do this in decimal. But with only two symbols in binary—or *base two*—values, a carry from one column to the column on the left occurs sooner in binary than in decimal, which has ten symbols and, therefore, can represent larger values with fewer numbers of digits. Adding $1 + 1$ in decimal requires no carry:

$$\begin{array}{r} 1 \\ + 1 \\ \hline 2 \end{array}$$

In decimal, the result can be represented by a single symbol (2). In binary, a single digit can be only 0 or 1; therefore, it takes an additional digit to represent a count of two things. Adding $1 + 1$ in binary, then, forces a carry to the column on the left:

$$\begin{array}{r} 1 \\ + 1 \\ \hline 10 \end{array}$$

The result is *not* ten. The result is *two* expressed as the base two value 10. As you know, adding 1 to decimal 9 (the highest single digit in base ten) gives 0 in that column with a carry to the next column to the left. Likewise, adding 1 to binary 1 (the highest single digit in base two) gives 0 in that column with a carry to the next column to the left. Adding in binary is no different from adding in decimal—you just run out of symbols more quickly and, as a result, have to carry a 1 to the left more frequently. With this rule in mind, you can add any two binary values. Let's try this with a more complex addition, writing the carries above the values being added:

11 1 11	(carries)
0110 1010	(first value)
+0010 1110	(second value)
<hr/> 1001 1000	(sum)

NOTE

To avoid confusion, don't say "hundred" for binary 100 or "ten" for 10. Say "one-zero-zero" and "one-zero" pronouncing each digit.

The Power of 2

In most number systems (at least in those of the modern world), the position of a digit represents a value equal to the digit multiplied by the column's significance, or *power*. In decimal, for instance, the 3 in 300 stands for the number of hundreds—the power of the third column to the left. The rightmost column represents 10 to the zero power, written 10^0 . The second column to the left represents 10^1 ; the next represents 10^2 ; and so on. To find the power of any column, write the number of the column's position (starting with 0) as the exponent to the number base. Then, multiply that many base values to find the significance of the column. For example, the value 10^3 equals $(10 \times 10 \times 10)$, or 1000.

NOTE

Any base value to the zero power (n^0) is traditionally considered to equal 1. Technically speaking, the value of a digit in the rightmost column equals the value of that digit times 1.

Binary values are positional, too. Because binary values are expressed in base 2, binary columns represent the powers of 2. In binary, the 1 in 100 stands for one count of the third column's power, or 2^2 , which in decimal equals 4 (2×2); therefore, 100 in binary is equivalent to 4 in decimal. 1000 in binary equals 2^3 , or 8 ($2 \times 2 \times 2$), and so on.

Finite Values

Computer programs usually represent numbers with fixed numbers of bits in one or more bytes. This makes it practical to store numbers in memory, which is divided into byte-size pieces. At the same time, a fixed number of bits places a limit on the number of values that can be expressed. A single byte of 8 bits, for example, can express values from 0 to 255. A 16-bit word can express values from 0 to 65,535, and so forth. To express higher values requires more bits.

To calculate the maximum value that can be expressed within a fixed number of bits n , use the formula $2^n - 1$. For example, if n is 8, then the maximum value you can express in 8 bits equals $(2 \times 2 \times 2 \times 2 \times 2 \times 2 \times 2 \times 2) - 1$, or 255. Counting 0, there are 256 values in the range 0 to 255; therefore, the formula for the *number* of values that a fixed number of bits n can express equals 2^n . Know these boundaries well. You'll bounce into them all the time.

The K Game

Most people use a convenient shorthand to represent 1,000-byte, or *kilobyte*, quantities of memory as in 64K, 128K, and 640K. These convenient powers of 2—in all cases equal in binary to a 1 followed by several zeros—have been adopted by computer users everywhere as accurate measurements of RAM, despite the fact that a 64K computer actually has 65,536 bytes—the full number of values that can be expressed in 16 bits, or 2^{16} .

The address range of the 8086 processor, by the way, is 2^{20} , or 1,048,576 bytes—a so-called *megabyte* plus change. As you'll learn in later chapters, the 8086 uses some hocus-pocus to reduce two 16-bit address values down to a 20-bit physical address that actually locates individual bytes within this memory range. The 80486 processor can address up to 2^{32} bytes. That's four *gigabytes* of memory, or exactly 4,294,967,296 bytes. (I don't know why they call a billion bytes a gigabyte. Maybe it should be a billybyte.)

When working with address values in binary, try to get used to thinking in powers of 2. Measuring memory in K is quick and easy, but it is just too vague for the exacting world of assembly language programming.

Binary and Hexadecimal

Hexadecimal values are represented in base 16—in other words, with the 16 symbols 0, 1, 2, 3, 4, 5, 6, 7, 8, 9, A, B, C, D, E, and F. The hexadecimal digits are made up of the ten decimal digits 0 to 9 plus the six letters A to F.

NOTE

Some early computer texts used a different set of six letters in place of A to F. One suggested U, V, W, X, Y, and Z. Another proposed lowercase t, e, d, h, f, l. Believe it or not, you were supposed to remember t for tens, e for elevens, d for dozens, h for thirteens, f for fourteens, and l for fifteens! Fortunately, this didn't become one of computerdom's more popular standards.

Counting in hexadecimal is easy (see Table 3.1) if you remember that 1 + F equals hexadecimal 10 (16 in decimal). Remember, 1 plus the last symbol in any positional number system equals the symbol 10 expressed in that number system.

Because the hexadecimal number system contains 16 symbols and because 16 is a power of 2 (2^4), values in binary are easily converted to and from hexadecimal by substitution. Plainly, it's easier to write and remember hex values like B800 than it is to write and remember the binary equivalent: 1011 1000 0000 0000. Here's another example:

```
0100 1111 0101 1100
 4     F     5     C = 4F5C
```

The binary value (top) converts to hex (bottom) by substitution from Table 3.1. To convert from hex to binary, substitute in the other direction, replacing hex digits with their 4-bit binary equivalents.

Converting Hexadecimal and Decimal Values

Converting between hexadecimal and decimal is not as simple as converting between hexadecimal and binary values. The easiest way to accomplish such conversions is to use a programmer's calculator designed for this purpose. Or, use a software calculator such as the one in Borland's SideKick or Microsoft Windows. That way, you can pop up the calculator in the middle of typing a program, do the calculation, and go right back to work.

For the times when you can't get to your calculator, it pays to know how to convert hexadecimal and decimal values by hand. This is not as difficult to do as you may think. As in binary and decimal, hex digits are positional, representing increasing powers of 16 from right to left. Knowing this provides a quick trick for converting any 16-bit value from hexadecimal to decimal, requiring you to memorize only these four values:

$$\begin{aligned} 16^0 &= 1 \\ 16^1 &= 16 \\ 16^2 &= 256 \\ 16^3 &= 4,096 \end{aligned}$$

The exponents represent column positions in the hexadecimal value, numbered from right (0) to left (3). To convert hexadecimal to decimal, multiply the value of each hex digit by the power of its column. Add the multiplications, and you're done. For example:

$$8B92 = (8 \times 4096) + (11 \times 256) + (9 \times 16) + (2 \times 1) = 35,730$$

The hexadecimal value 8B92 equals 35,730 in decimal. For the hex digits A-F, use Table 3.1 to convert mentally to decimal before multiplying. In this example, (B x 256) is equivalent to (11 x 256). To convert from decimal to hexadecimal, reverse the process, dividing by powers of 16. Although this is a little more difficult, you can do the calculation by hand this way:

$$\begin{aligned} (35,730/4096) &= 8.72 \dots & (8 \times 4096) &= 32,768 & (35,730 - 32,768) &= 2962 \\ (2,962/256) &= 11.57 \dots & (11 \times 256) &= 2816 & (2,962 - 2,816) &= 146 \end{aligned}$$

$$\begin{array}{lll}
 (146/16) = 9.125 & (9 \times 16) = 144 & (146 - 144) = 2 \\
 (2/1) = 2 & (2 \times 1) = 2 & (2 - 2) = 0 \\
 & : & \\
 & : & \\
 & 8, 11, 9, 2 = 8B92 &
 \end{array}$$

Don't be overwhelmed—this isn't as confusing as it probably looks. Reading each row from left to right, look at how the expressions divide a decimal value by decreasing powers of 16, throw out the remainder, multiply the whole number by the same power, and subtract the result from the total. Then the next line uses the result of this calculation in the next division, repeating the process until reaching 0. If the first division is greater or equal to 16, start with a higher power. If a subsequent division is greater or equal to 16, you've made a mistake. Written down, the expressions seem to be a frightening load of work. But with practice and an inexpensive decimal calculator, you can do the conversion in a few seconds. Notice how the hex digits pop out of the divisions—8, 11 (b), 9, 2, or hexadecimal 8B92.

Two's Complement Notation

Unsigned integers include 0 and all positive whole values. Signed integers include the unsigned integers plus whole values less than 0. Within a fixed number of bits, there are a fixed number of signed and unsigned values. For instance, in 4 bits, the smallest value is 0000; the largest unsigned value is 1111. Converting to decimal, this equals the range of 0-15—a total of 16 possible values including 0. In 8 bits, the largest unsigned value is 1111 1111, or 255 decimal—making a total of 256 possible values in one 8-bit byte. The whole numbers in mathematics may be infinite, but in computer programming, whole numbers have definite limits.

Because you can express only a fixed number of values within a fixed number of bits, representing negative values in signed binary requires some trickery. A value's sign is either positive (+) or negative (-); therefore, a single bit can represent the sign of an integer—1 for negative and 0 for positive. That leaves the rest of the bits to represent the signless *absolute value*. This observation leads to a convenient representation for negative integers in binary, called the *two's complement*.

NOTE

For simplicity, 0 is considered to be a positive value even though, strictly speaking, 0 is neither positive nor negative.

In two's complement notation, if the leftmost bit is 1, the value is negative. If the leftmost bit is 0, the value is positive or 0. To convert between positive values and two's complement notation, first negate each bit (step 1 below)—changing the ones to zeros and the zeros to ones—forming an intermediate value called the *one's complement*. Add 1 to this value (step 2 below), forming the final two's complement result:

0110 1010	(original value)
1001 0101	(1. negate each bit—one's complement)
+ 1	(2. add 1)
1001 0110	(two's complement)

The steps are reversible. To convert a two's complement value to its absolute value, perform the same steps. For example:

1111 1110	(two's complement)
0000 0001	(1. negate each bit)
+ 1	(2. add 1)
0000 0010	(absolute value)

As this example shows, the absolute value of the 8-bit two's complement 1111 1110 equals 0010, or 2. In other words, 1111 1110 is decimal -2, represented as a signed binary, two's complement value. The conversion steps work no matter how many bits are in the value—4, 8, 16, or more. The leftmost bit always indicates whether a value is positive (0) or negative (1). If negative, performing the two's complement operations finds the absolute value.

NOTE

Another way to form the two's complement is to subtract a binary value from 0, although negating and adding 1 is simpler to do by hand.

A good way to understand the purpose of the two's complement is to remember the number line you no doubt learned in math class. (See Figure 3.2.) Values to the right of 0 are positive; values to the left are negative. The line extends in two directions farther than human minds can imagine.

With a fixed number of positions for digits—as in a computer's memory—you might imagine the familiar number line to be circular. (See Figure 3.3.) The binary values (outside the circle) orbit sequentially to the right. Adding one to the highest value (1111) returns to 0. Signed decimal equivalent values are inside the circle; unsigned values are outside, with the binary values written under their decimal counterparts. This figure assumes four binary digits are available, although the same idea holds for any fixed number of bits.

From Figure 3.3, you can see that exactly half of the signed values are negative (-1 to -8). The other half are positive (0 to 7). The unsigned values (0 to 15) use the same binary values as the signed quantities, a fact that leads to an important rule to remember: *Negative binary values are negative by convention only*. Within a fixed number of bits, all unsigned values have corresponding signed values represented by the identical bit patterns such as (9, -7), (13, -3), and (15, -1). The binary values for the negative numbers are simply represented in two's complement form.

Figure 3.2.
Signed-integer number line.

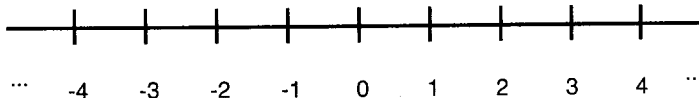
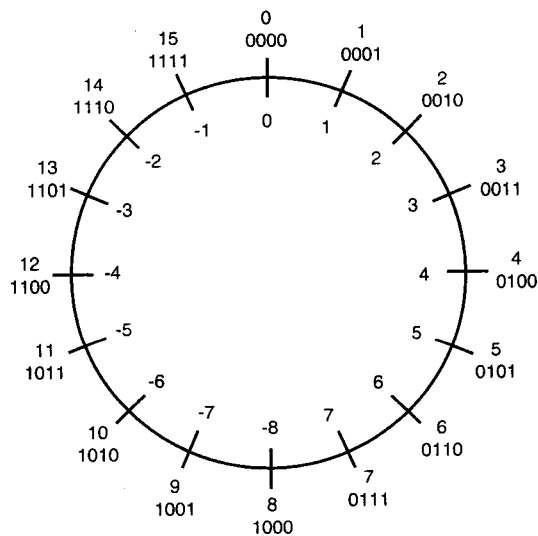

Figure 3.3.
With a fixed number of binary digits available, it's convenient to imagine the familiar number line as a circle.



NOTE

A common misconception is that there is one more negative value than there are positive values in signed, two's complement notation. Considering that 0 is positive, this is not true—there are equal numbers of positive and negative values. Count them in Figure 3.3.

Subtracting by Adding

Two's complement notation is important in binary arithmetic because it gives computer circuits the ability to subtract by adding. Also, performing the two's-complement steps—negating the bits and adding 1—makes it easy to find the absolute value of negative binary values expressed in two's complement notation. If you understand the idea of a circular number line (Figure 3.3), you can easily grasp these ideas. Obviously, adding decimal $1 + 9$ equals 10, equivalent to the signed value -6 (binary 1010) on the circular number line—the identical result received by subtracting $1 - 7$. Therefore, instead of subtracting $1 - 7$, you can instead add $1 + 9$ and then look up the negative value on the circular number line as the two's complement of the result.

Fortunately, in 8086 assembly language, you don't have to subtract by adding two's complements because the processor has instructions for subtracting values. Even so, it pays to understand the mechanism. The rule is: To subtract one binary value from another, convert the second value to two's complement notation and add. For demonstration, let's start with a simple subtraction that produces a positive result:

$$\begin{array}{r} 1001 \\ - 0101 \\ \hline 0100 \end{array} \quad \begin{array}{r} 1001 \\ + 1011 \\ \hline 1\ 0100 \end{array} \quad \begin{array}{r} 9 \\ - 5 \\ \hline 4 \end{array}$$

On the left, 5 (0101) is subtracted from 9 (1001) directly. In the middle, the two's complement of 5 (1011) is added to 9. The right column shows the subtraction in decimal. The two calculations give identical results, but with a carry out of the middle column for the two's complement addition, indicating the result is positive. Now watch what happens when you subtract $5 - 9$, giving a negative answer:

$$\begin{array}{r} 0101 \\ - 1001 \\ \hline ?100 \end{array} \quad \begin{array}{r} 0101 \\ + 0111 \\ \hline 0\ 1100 \end{array} \quad \begin{array}{l} \text{(two's complement of } 1001-9 \text{ decimal)} \\ \text{(two's complement of } 0100-4 \text{ decimal)} \end{array}$$

The left column requires a borrow where none is to be had. On the right, subtracting by adding the two's complement of 9 decimal to 5 gives 1100, which you know is negative because the leftmost bit in 1100 is 1. The two's complement of this is 0100, or 4, the absolute value of -4 , which is the result of subtracting $5 - 9$. In this way, the system of two's complements allows you to subtract binary values by adding—simple as 1, 10, 11.

NOTE

8086 processors contain two instructions to create the one's and two's complements of binary values. The **not** instruction forms the one's complement. The **neg** instruction forms the two's complement. You'll meet these instructions again in Chapter 4.

Logical Operators

Three logical operations—AND, OR, and XOR (exclusive or)—are as common in assembly language programming as weeds in a garden. (On second thought, they're not as common as weeds in our garden.) AND, OR, and XOR give you total control over manipulating the individual bits in binary values. You can set and reset single bits without affecting others, isolate one or more bits from bytes and words, and perform other operations.

Table 3.2 lists the truth tables for AND, OR, and XOR, showing the effects that a logical operation has on 2 bits. AND is represented by $\&$, OR by $|$, and XOR by x .

Table 3.2. AND, OR, XOR Truth Tables.

AND ($\&$)	OR ($ $)	XOR (x)
$a \& b = c$	$a b = c$	$a x b = c$
$0 \& 0 = 0$	$0 0 = 0$	$0 x 0 = 0$
$0 \& 1 = 0$	$0 1 = 1$	$0 x 1 = 1$
$1 \& 0 = 0$	$1 0 = 1$	$1 x 0 = 1$
$1 \& 1 = 1$	$1 1 = 1$	$1 x 1 = 0$

Study Table 3.2 carefully. The result of ANDing two bits equals 1 only if bit a and bit b also equal 1. The result of ORing two bits is 1 if bit a or bit b equals 1. The result of XORing two bits is 1 only if bit a or bit b exclusively equals 1.

Masking with AND

AND is most often used to mask (isolate) bits in byte and word values. Referring to the AND truth table in Table 3.2, you can see that a 1 passes through a a to c only if there is a corresponding 1 in column b . You can use this observation to create *filters* to extract bits from bytes. Here's a typical example:

```

0101 1101 (original value)
& 0000 1111 (AND mask)
-----
0000 1101 (result)

```

The mask is 0000 1111, of 0F hexadecimal. Because ANDing 2 bits gives a 1 only if both bits are 1, only the least significant 4 digits on the right pass through the mask unchanged. The most significant 4 digits on the left are masked out by the zeros in the AND mask. Perform the truth table operations on each column of this example to prove to yourself that the mask works.

Another typical use for AND masks is to test the value of single bits. First, create a mask with a 1 in the test bit position. Then, AND this mask with the test value, allowing a candidate bit to pass through. For example, suppose you want to test the leftmost bit, perhaps to determine whether a value is negative in two's complement notation:

0111 1010	1001 1111	(original values)
& 1000 0000	& 1000 0000	(AND masks)
0000 0000	1000 0000	(results)

The mask (80 hexadecimal) isolates the most significant digit—the one farthest to the left. If the original value has a 0 in this position, the result equals 0. If the original value has a 1 in this position, the result is not 0. Following the AND operation, testing if the result is 0 tells you whether the original value is negative (in two's complement notation). In 8086 programming, as you will learn, there are other ways to test for negative values. Even so, masking single bits this way is an important technique to know.

Setting Bits with OR

Contrasting the action of AND, logical OR is most often used to change the value of individual bits without affecting other bits in a byte. As Table 3.2 shows, a 1 bit in column *b* always results in a 1 bit in the result *c*, while a 0 in column *b* allows the original bit value from column *a* to pass through to the result. Notice that this pass-through action is the opposite of the AND operation, where a 1 bit in the mask allows bit values to pass through. These facts allow OR to set any bit in a byte, as this example demonstrates:

0010 1011	(original value)
1000 0000	(OR mask)
1010 1011	(result)

The OR mask (80 hexadecimal) changes the most significant digit in the original value from 0 to 1. (If that bit was already 1, then it passes through unchanged.) Referring to the OR truth table in Table 3.2, perform the OR operation on each column in this example to prove to yourself how this works.

Combined with AND, OR is frequently used to change the settings of a device's switches, economically represented as single bits in memory, perhaps stored in registers inside the device's interface card plugged into the computer. (A register is a small amount of special-purpose memory, usually inside an integrated circuit chip. The 8086 processor as well as other chips on your PC's circuit board have many such registers to hold meaningful values.) To see how AND and OR can be used to control devices, imagine a light attached to your computer and suppose that bit 3 of a certain register byte value represents the switch to turn the light on (1) and off (0). Bits 5, 6, and 7 represent the light's intensity in eight steps from

000 (dim) to 111 (bright). Other bits have other meanings and you must be careful not to change bits that are of no concern to you. Representing the taboo bits as question marks, the intensity as *v*, and the switch as *s*, the following operations turn on the light and change the intensity to 3:

```

7654 3210  (bit position numbers)
vvv? s???  (original settings)
& 0001 0111 (AND mask)
-----
000? 0???  (result of AND)
| 0110 1000 (OR mask)
-----
011? 1???  (result)

```

First, an AND mask strips the original value of any 1 bits in positions 7, 6, 5, and 3—the bits to be changed to the new settings. The ones in the AND mask preserve the original values in the forbidden positions—4, 2, 1, and 0—that must not be changed. After this, an OR mask sets bits 7, 6, and 5 to 011 (3 decimal) and also sets bit 3 to 1. Notice how zeros in the OR mask allow the values of the preserved bits (?) to pass through unharmed. Now, compare the bottom and top lines. The intensity value *vvv* is changed to 011 and the switch *s* to 1. The bits that control other devices are undisturbed.

NOTE

When setting individual bits in bytes, you'll almost always use an AND followed by OR. This is one assembly language's most fundamental sequences, and you should learn it by heart.

The Exclusive OR Club

The third common logical operator, XOR, is similar to OR but with one important difference. As you can see from Table 3.2, the result *c* equals 1 only when one but not both of the original two values is 1. If both of the original two bits are the same, then the result of XOR is 0. This property provides a handy tool for toggling individual bits on and off—without having to know beforehand what the original bit values are. As with OR, a 0 in the XOR mask allows an original bit value to pass through. This example helps explain the idea:

```

1010 0010 (original value)
⊕ 1110 1011 (XOR mask)
-----
0100 1001 (result)

```

Applying XOR to these two values, when both bits are equal, the result is 0. When both bits are different, the result is 1. Using Table 3.2 as a guide, verify that each of the columns in this example is correct. Then watch what happens when the XOR mask has a 1 bit in every position:

```

    1010 0101 (original value)
⊗ 1111 1111 (XOR mask)
-----
    0101 1010 (result)

```

Compare the top and bottom lines. Each bit in the original value is reversed in the result. All the ones are converted to zeros; all the zeros, to ones. (Adding 1 to this result gives the two's complement of the original value. How interesting.) What's more astounding about XOR is that, as if by magic, repeating the identical operation restores the original value:

```

    0101 1010 (result from previous example)
⊗ 1111 1111 (same XOR mask, too)
-----
    1010 0101 (original value!)

```

You can understand this apparent sleight of hand by observing that, if an XOR mask toggles every bit in the original for which there is a corresponding 1 in the mask, then reapplying that same mask to the result has to again toggle every bit back to its original value. This action—the ability to combine a value via XOR and then restore the original value with a second XOR—is frequently used in graphics software to allow objects, represented by bit patterns, to pass through each other harmlessly. Other uses for this property are found in communications and encryption software.

As a kind of side show effect—because of XOR's toggling action—every 1 bit in the mask toggles the corresponding bit in the original value on or off. Exclusively ORing any value with itself always gives 0. For example:

```

    0111 1101 (original value)
⊗ 0111 1101 (same value as an XOR mask)
-----
    0000 0000 (result)

```

Remember: The result is 0 when two exclusive-ORed bits have the same value. Obviously, XORing two identical values can have only one effect—all zeros in the result. By the way, you'll see this trick often in 8086 assembly language programs. There are other ways to change a byte to 0, but XORing a value with itself is one of the fastest methods available.

NOTE

Subtracting a value from itself also produces 0. For an interesting experiment, try adding the two's complement of a value to itself. What do you get for the result? As you can see, there is more than one way to skin a byte.

Returning to the example of a light attached to a computer, you could perform this XOR operation to toggle the light on and off without affecting the other bit values:

```

vvv? s??? (original settings)
⊗ 0000 1000 (XOR mask)
vvv? x??? (result)

```

A 1 bit in the XOR mask toggles the corresponding bit *s* in the original value to its opposite value *x* in the result without affecting any other bits. The importance of this operation is that the program doesn't have to know the original value *s* to toggle the value. All that's known is that the result is opposite of the original. If the light was on, now it's off. If it was off, now it's on.

Shifting and Rotating

Shifting bits left and right is another common operation performed on binary values. A shift to the left typically moves a 0 bit into the LSD position, pushing the former MSD off the edge of the cliff at the far left. A shift to the right does the same, but moves a 0 bit into the MSD position, losing the former LSD. Variations on this theme store the lost bit and move the value of another single-bit flag into the new LSD or MSD position. Other variations move the LSD or MSD around to the other end—or through a single-bit flag—causing the bits to rotate.

Because bit shifting is such a common operation in assembly language programming, we'll pick up this discussion again when meeting the 8086 shift and rotate instructions. But, for now, there are two concepts you should understand: multiplication by shifting left and division by shifting right. To understand how it is possible to multiply and divide by shifting, examine this addition:

```

0110 1011 (original value)
+ 0110 1011 (added to itself)
1101 0110 (shifts value left!)

```

As the top and bottom lines indicate, adding a value to itself causes the bits to shift one position to the left. Stated differently, a binary multiplication by 2 is equivalent to shifting the bits in the value once to the left. Continuing to shift the bits left multiplies the result again by 2, thus multiplying the original value by 4, or 2^2 . This leads to a general rule: To multiply any value by a power of 2, shift the value left by the exponent's value. To find x times 2^4 —that is, to multiply x by 16—shift x left 4 bit positions.

Obviously, if shifting left multiplies binary values by successive powers of 2, shifting right divides values by 2, 4, 8, and so on. To find the result of 1010 1111 (AF hexadecimal, or 175 decimal) divided by 4, just shift the bits right twice:

```
1010 1111 (original value)
0101 0111 (divided by 2)
0010 1011 (divided by 2 more)
```

The result, 0010 1011 (2B hexadecimal, or 43) equals the result of 175 divided by 4—throwing away any remainder, that is. Similar to multiplication, to divide by any power of 2, shift the original value right by the exponent's value.

There are several catches to these tricks. For one, you can multiply and divide only unsigned values by powers of 2. For another, the product must fit within the size of the destination. (Multiplying 1111 1111 by 2, for example, is *not* equal to 1111 1110—a ninth bit is needed to represent the correct result.) And, because bits are lost off the forward end of the shift—with 0 bits coming in from the leading edge—dividing ignores any remainder in the result. Despite these restrictions, because shifting bits is one of the fastest operations a digital computer processor can perform, whenever you can multiply or divide by shifting, it pays to do so. In future chapters, you'll see programming examples that prove this point.

Summary

Bits and bytes fuel the computer processor. There are 8 bits in a byte; 2 bytes in a word; 4 bytes in a doubleword; 6 bytes in a farword; and 8 bytes in a quadword. In memory, bytes are stored consecutively, each byte precisely located by a unique address. Word values are stored in byte-swapped order with the most significant bytes at higher addresses.

Well-dressed assembly language programmers need only four binary basics in their wardrobe: counting from 0 to 16 in binary; converting among binary, hexadecimal, and decimal values; understanding logical AND, OR, and XOR operations; and representing negative values in two's complement notation.

As in other positional number systems, columns from right to left in binary represent increasing powers of the number base. Because 16 is a power of 2, hexadecimal notation gives programmers a convenient way to represent binary values by substitution. Converting

between hexadecimal and binary is easy. Converting between decimal and hexadecimal is more difficult—probably best handled by a programmer’s calculator. Even so, you should learn how to do the conversion by hand, which is not so difficult once you know the tricks.

Negative values in binary are represented in two’s complement notation. A negative number’s MSD always equals 1. For simplicity, 0 is considered to be a positive value. Two’s complement notation allows processors to subtract by adding and also makes it easy to find the absolute value of any negative number expressed in two’s complement form.

The three logical operations AND, OR, and XOR are typically used to manipulate individual bits in binary values without disturbing other bits. AND masks combine with binary values to isolate one or more bits. OR masks can set individual bits to 1. XOR masks can toggle bits from 1 to 0 and back regardless of the original value. AND followed by OR is one of assembly language’s most common sequences and is typically used to change specific bit values without disturbing other bits in bytes.

Shifting bits left multiplies unsigned binary values by successive powers of 2. Shifting bits right divides unsigned binary values by powers of 2, throwing away any remainder. Because computers can shift bits very quickly, using these operations can help speed binary math in assembly language programs.

Exercises

- 3.1. What does the word “bit” stand for?
- 3.2. How many bits are there in a byte? How many bytes are in a word? How many words are in a quadword?
- 3.3. What do MSD, LSD, MSB, and LSB stand for?
- 3.4. What is the sum of the two binary values 0110 1011 1111 1001 and 1010 1011 1100 1000?
- 3.5. What are the hexadecimal equivalents of the binary values in question #4 (including the sum)?
- 3.6. How much in decimal does 2^7 represent? What column (bit number) in a binary value has the power of 2^7 ?
- 3.7. How much is 3ECA in decimal? How much is decimal 12,152 in binary? Try doing this by hand, even if you have a programmers calculator. (Hint: Convert the decimal value to hexadecimal and then to binary by substitution.)
- 3.8. What AND mask would you use to isolate bits 5, 3, and 2 in an 8-bit byte? What OR mask would you use to set bits 7 and 6 to 1? What XOR mask would you use to toggle a byte’s MSD on and off?

- 3.9. [Advanced] Given the job of setting bits 3 and 7 to 1 while toggling bit 2 on/off and preserving all other bits in a byte, what combination of masks and logical operators would you use?
- 3.10. How many bits are there in 2,048 farwords?
- 3.11. What are the one's and two's complements of the binary values 1011 1111, 0000 0001, 1000 0000, 1110 0001, and 1111 1111?
- 3.12. What is the decimal equivalent of the signed binary value 1111 1001? What is the decimal equivalent of these same bits as an unsigned binary value?
- 3.13. What is the maximum value that you can express in 6 bits? How many values can you express in 9 bits?
- 3.14. Multiply 0011 1001 by 4 using a bit shift. Divide 1001 1100 by 8 using bit shifts. Check your answers in decimal. Why can't you multiply 0101 0101 by 8 using bit shifting?

Projects

- 3.1. Count in binary and hexadecimal from 0 to 16 without referring to Table 3.1. Create your own binary-to-hex pocket reference.
- 3.2. Draw number circles similar to Figure 3.3 for 3- and 5-bit binary values.
- 3.3. Why do you suppose processors like the 8086 require words to be stored in byte-swapped order?
- 3.4. Write the bit numbers for a 16-bit word as depicted on the top of Figure 3.1.
- 3.5. Write the truth tables for AND, OR, and XOR without referring to Table 3.2.
- 3.6. Add several binary values to themselves. What do the results suggest?

4

CHAPTER

Programming in Assembly Language

- Memory Segmentation, 74
- 8086 Registers, 76
- Instruction Groups and Concepts, 80
- Arithmetic Instructions, 90
- Logic Instructions, 101
- Flow-Control Instructions, 110
- Processor Control Instructions, 126
- String Instructions, 131
- Summary, 139
- Exercises, 140
- Projects, 141

Memory Segmentation

Before learning about 8086 processor registers and the instruction set, it's helpful to understand how the 8086 addresses memory using a system of *segments* and *offsets*—two terms that have caused more than their fair share of confusion.

Representing address values internally in 20 bits, the 8086 processor can directly access up to 1 megabyte of memory. Because DOS, the ROM BIOS, and a few other items occupy some of that space in PCs, most software has to run in a smaller space of about 256K to 512K. If you want your programs to run on as many PCs as possible, limit your memory requirements to this range.

NOTE

Later model processors such as the 80386, 80486, and Pentium (also known as the 80586) emulate 8086 programming. The methods described in this chapter apply equally to all 80x86 CPUs.

No matter how much memory the processor can address, and no matter how many memory chips are installed inside the computer, the smallest memory unit remains the 8-bit byte. As mentioned earlier, each byte has a unique location, called the *physical address*, which programs specify to read and write the bytes they need. Obviously, you need a greater number of bits to represent the physical addresses of greater amounts of memory. If your computer had only 64K, then the address of any byte would comfortably fit in 16 bits, which can represent values from 0 to 65,535 ($2^{16} - 1$)—or 64K in round numbers. To address the PC's maximum 1 megabyte of memory requires a minimum of 20 bits. ($2^{20} - 1$ equals 1,048,575, or hexadecimal FFFFF.) The problem is: 8086 registers are only 16 bits wide. How is it possible for the 8086 processor to access the full megabyte of memory in a typical PC?

The answer is *memory segmentation*, a method the 8086 uses to divide its large address space into logical 64K chunks. With this method, the address of a specific byte can be expressed in two values: the address of the chunk, or segment, plus a 16-bit offset from the beginning of the segment. Together the combination of segment and offset values is called the *logical address*. The first byte in a segment is at offset 0000, the second at offset 0001, the third at 0002, and so on—no matter where the segment physically begins in memory. Figure 4.1 illustrates this idea, showing that each location in memory has both a physical address (right) and a logical address (left), expressed as an offset from the beginning of a segment boundary. With segmentation, the 8086 processor can efficiently address up to 1 megabyte of memory while using relatively small, 16-bit registers. As an additional benefit, segmentation makes it easy to move programs to new physical locations by changing only the segment base address. The offset values within a segment require no adjustments, allowing for *relocatable programs* that can run identically in different memory locations.

Figure 4.1.

Logical addresses all have equivalent physical addresses in memory.

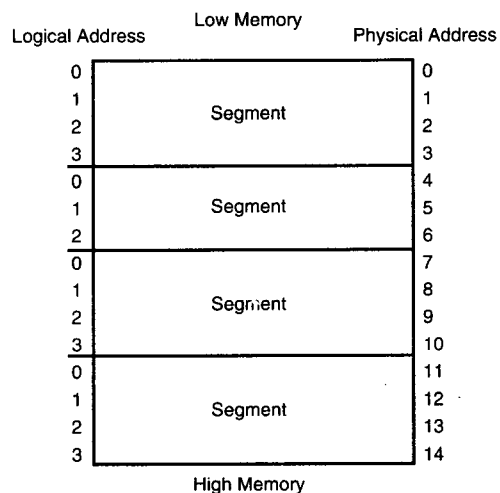

Paragraphs, Segments, and Offsets

To locate the beginnings of memory segments, the 8086 processor contains four 16-bit segment registers. Internally, the processor combines the value of one segment register with a 16-bit offset (the logical address) to create a 20-bit physical address. It does this by first multiplying the segment value by 16 and then adding the offset to the result. Because of the multiplication—equivalent to shifting the bits left four times, as you recall from Chapter 3—segment boundaries fall on physical address multiples of 16 bytes. Each of these 16-byte memory tidbits is called a *paragraph*. A simple calculation proves there are a maximum of 65,536 paragraphs—and, therefore, an equal number of segment boundaries—in the 8086’s 1-megabyte address space (1,048,576/16). (Notice that this also equals the number of values you can express in one 16-bit segment register.) Here are a few other important facts about segments to keep in mind:

- Segments are not physically etched in memory—a common misconception. A segment is a logical window through which programs view portions of memory in convenient 64K chunks.
- A segment’s starting location (that is, the segment’s logical address) is up to you and can be any value from 0000 to FFFF hex. Each logical segment value (0, 1, 2, ..., 65,535) corresponds to a physical paragraph boundary (0, 16, 32, ..., 1,048,560).
- Segments can be as small as 16 bytes or as large as 64K (65,536 bytes). The actual size of a segment is up to you and your program.
- Segments do not have to butt up against each other physically in memory, although they often do.

- Segments can overlap with other segments; therefore, the same byte in memory can have many different logical addresses specified with different but equivalent segment and offset pairs. Even so, each byte has one and only one 20-bit physical address.

This last point confuses almost everyone on their introduction to memory segmentation. Two different segment and offset pairs can (and often do) refer to the same byte in memory. If you remember how the processor creates a 20-bit physical address—multiplying the segment value by 16 and adding the offset—you can see that the segment:offset hexadecimal values 0000:0010 and 0001:0000 refer to the same physical location. Duplicating in decimal how the 8086 processor converts these logical addresses to physical addresses, each calculation— $(0000 \times 16) + 16$ and $(0001 \times 16) + 0$ —gives the same result, 16.

NOTE

By custom, a segment and offset logical address is written with two 4-digit hexadecimal numbers separated by a colon, for example, 0140:001A and F000:0010. When you see values like these, you should assume they are hexadecimal. This is easy to forget with addresses like 0100:1024 and 0000:0010, which are not obviously in hexadecimal.

8086 Registers

Figure 4.2 illustrates the 8086 registers. The same registers are available in all 80x86 models. (The 80386, 80486, and Pentium CPUs have additional registers and extensions that don't concern us here.) If you limit your register use to those listed in Figure 4.2, your programs are guaranteed to run on all PCs. The registers are grouped into five categories:

- General-purpose registers (ax, bx, cx, dx)
- Pointer and index registers (sp, bp, si, di)
- Segment registers (cs, ds, ss, es)
- Instruction pointer (ip)
- Flags (of, df, if, tf, sf, zf, af, pf, cf)

All 8086 registers are 16 bits wide. In addition, the four general-purpose registers—ax, bx, cx, and dx—are subdivided into high and low 8-bit halves. The 16-bit ax register, for example, is composed of two 8-bit parts, ah and al. Register bx is divided into bh and bl; cx, into ch and cl; and dx, into dh and dl. This flexible arrangement lets you operate directly on the full 16-bit register width or work separately with the register's two 8-bit halves. Remember that changing the value in the 16-bit ax also changes the register's two 8-bit halves al and ah. Likewise, changing the value in cl also changes the value of cx.

Figure 4.2.
8086 registers.

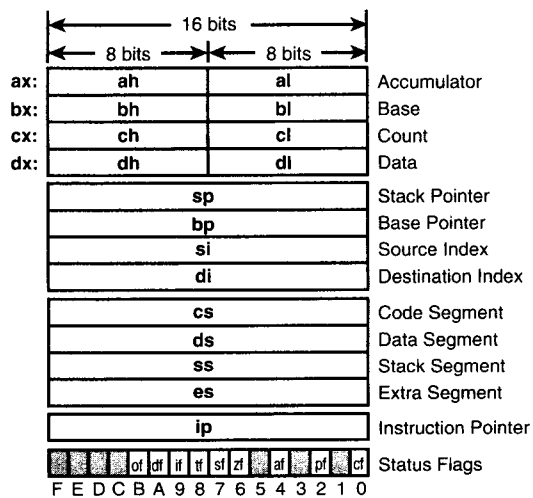

NOTE

In this text, registers are written in lowercase—`cs`, `ax`, `si`, and so on. In programs and in other references, you'll often see the same registers in uppercase, as `AX`, `BX`, `DH`. Both forms are correct.

General-Purpose Registers

Assembly language programs refer to registers by their mnemonics, `ax`, `cl`, `ds`, and the like. But the registers also have less familiar names as shown to the right of Figure 4.2. (The names are never used directly in programs, though.) The *accumulator* `ax` is usually used to accumulate the results of additions, subtractions, and so forth. The *base* register `bx` often points to the starting address (called the base) of a structure in memory. The *count* register `cx` frequently specifies the number of times some operation is to repeat. And the *data* register `dx` most often holds data, perhaps passed to a subroutine for processing. These definitions are by no means fixed, and most of the time it's up to you to decide how to use a general-purpose register. For example, just because `cx` is called the count register, there's no reason you can't count things using `bx`. In some cases, however, certain 8086 instructions require specific registers.

Pointer and Index Registers

Contrasting the four general-purpose registers, other 8086 registers in Figure 4.2 are closely related to specific operations. The *stack pointer* `sp` always points to the top of the processor's

stack. (We'll tackle stacks in detail a bit later.) The *base pointer* `bp` usually addresses variables stored inside the stack. *Source index* `si` and *destination index* `di` are known as *string registers*. Usually, `si` and `di` serve as workhorses for easing the load of processing byte strings.

NOTE

A byte string is not the same as a high-level language's character string data type. In assembly language, a string is simply a series of consecutive bytes. To avoid confusion, I'll use the term *character string* to refer to an ASCII string as found in most high-level languages. A plain string can be any sequence of bytes, which might also represent characters.

Segment Registers

The four segment registers—`cs`, `ds`, `ss`, and `es`—locate the start of four 64K segments in memory, as illustrated in Figure 4.3. A program is free to allocate more than four segments but, in that case, has to swap the correct values in and out of one or more segment registers to address the additional segments.

Segment registers are highly specialized. You can't directly perform math on segment registers or use them to hold the results of other operations. The *code-segment register* `cs` addresses the start of the program's machine code in memory. The *data-segment register* `ds` addresses the start of the program's variables. The *stack-segment register* locates the start of the program's stack space. The *extra-segment register* `es` locates an additional data segment if needed, although in many programs, `es` and `ds` address the same memory, facilitating some operations tied to these registers. Actual segment order does not have to match the order shown in Figure 4.3. As explained before, segments may be stored anywhere in memory and in any order.

Figure 4.3.
Segment registers address four memory segments.

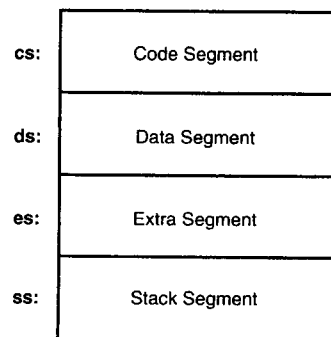

Instruction Pointer

The special-purpose *instruction pointer* `ip` specifies the next machine-code instruction to be executed, relative to the segment located by `cs`. You'll rarely (if ever) refer to `ip` directly. Instead, you'll use instructions that change `ip` (and possibly `cs`) to alter the location of the next instruction to be executed, thus changing the flow of the program. For example, calling a subroutine causes the address of that routine to be loaded into `ip` (or into the `cs:ip` pair).

Flags

Although the *status flags* register is 16 bits wide, only 9 bits are used. (See Figure 4.2.) The other 7 bits are of no use to programs. Individual flag bits are represented by single letters `o`, `d`, `i`, `t`, `s`, `z`, `a`, `p`, and `c`. Some references (including this one) frequently refer to these as `of`, `df`, `if`, and so on. Table 4.1 lists the full name of each flag bit.

Most of the time, the 8086 flag bits reflect the result of various instructions and operations. For example, after an addition, the carry flag `cf` indicates if the result generated a carry. The overflow flag indicates if the result of a signed addition cannot be represented correctly within a certain number of bits. Flags also serve multiple purposes. For instance, you might shift a register's bits left, transferring the former MSD into the carry flag `cf` for inspection. Other instructions can then take action based on the setting of this and other flag bits. Or you might use `cf` as a single-bit warning device to indicate that an error occurred, allowing other parts of the program to be aware that something is amiss. As you learn each assembly language instruction, you'll also learn the various roles that flags play in a program's actions.

Table 4.1. 8086 Flags.

<i>Symbol</i>	<i>Full Name</i>
<code>o</code> or <code>of</code>	Overflow flag
<code>d</code> or <code>df</code>	Direction flag
<code>i</code> or <code>if</code>	Interrupt enable flag
<code>t</code> or <code>tf</code>	Trap (single-step) flag
<code>s</code> or <code>sf</code>	Sign flag
<code>z</code> or <code>zf</code>	Zero flag
<code>a</code> or <code>af</code>	Auxiliary flag
<code>p</code> or <code>pf</code>	Parity flag
<code>c</code> or <code>cf</code>	Carry flag

Instruction Groups and Concepts

All 8086 instructions are divided by function into six categories. The rest of this chapter examines each of these groups and lists short programs that you can use to view the operation of many 8086 instructions. (Future chapters will introduce the remaining instructions.)

The six groups are:

- Data transfer instructions
- Arithmetic instructions
- Logic instructions
- Flow-control instructions
- Processor control instructions
- String instructions

NOTE

Chapter 16's 8086 reference lists each instruction with programming examples and full descriptions of the kinds of data elements that instructions can process. Please refer to Chapter 16 for additional details as you meet new 8086 instructions here.

Data Transfer Instructions

Table 4.2 lists the 8086 data transfer instructions. There are four subdivisions in this group: General, Input/Output, Address, and Flag. The operands to the right of each mnemonic specify the data elements required by the instruction. Most instruction mnemonics specify destination and source operands. Others require one or no operands.

Let's look at the first data transfer instruction `mov` and see how it works. Probably, `mov` appears in assembly language programs more frequently than any other instruction. From Table 4.2, you can see that `mov` requires a source and a destination operand. Notice that the source is written after the destination, implying that `mov` operates this way:

```
mov destination <-- source
```

Table 4.2. Data Transfer Instructions.

<i>Mnemonic/Operands</i>	<i>Description</i>
General Instructions	
<code>mov destination, source</code>	Move (copy) byte or word
<code>pop destination</code>	Pop data from stack
<code>push immediate</code>	Push data onto stack
<code>xchg destination, source</code>	Exchange bytes and words
<code>xlat/xlatb table</code>	Translate from table
Input/Output Instructions	
<code>in accumulator, port</code>	Input (get) byte or word
<code>out port, accumulator</code>	Output (put) byte or word
Address Instructions	
<code>lds destination, source</code>	Load pointer using ds
<code>lea destination, source</code>	Load effective address
<code>les destination, source</code>	Load pointer using es
Flag Instructions	
<code>lahf</code>	Load ah from (some) flags
<code>popf</code>	Pop flag register from stack
<code>pushf</code>	Push flag register onto stack
<code>sahf</code>	Store ah into (some) flags

The source data moves in the direction of the arrow, from right to left. Be careful not to reverse the operands, a typical and potentially disastrous mistake. In assembly language programs, the following instruction moves the value of the bx register into the ax register:

```
mov ax, bx ; ax <-- bx
```

If ax equals 0000 and bx equals 0123h, then this instruction sets ax equal to 0123h. The value of bx does not change. Some programmers like to use a comment to clarify the direction that the data moves. Here's an example:

```
mov cx, [numPages] ; cx <-- [numPages]
```

This mov instruction moves the value stored at numPages into the cx register. The brackets around numPages are important. The label numPages specifies a memory address. But, with brackets, [numPages] stands for the data stored at that address. This concept—that a label specifies the address of data stored in memory—is vital to your understanding of assembly language programming. At all times, you must be careful to specify whether an instruction is



to operate on an address value or on the data stored at that address. Brackets are simply tools for this purpose, but you must remember to use them correctly.

You can move data from registers to memory, too. For example, this copies the value in the 8-bit register `dl` to the address specified by `level`:

```
mov [level], dl ; [level] <-- dl
```

From the brackets, you know that the value of `dl` moves to the location to which `level` points. Moving data around this way—copying one register value to another and transferring data from a register to a location in memory—are some of the most common operations in assembly language programming. One thing `mov` can't do, however, is transfer data directly between two memory locations. This never works:

```
mov [count], [maxCount] ; ???
```

To move the value stored at `maxCount` into the location addressed by `count` instead requires two steps, using a register as an intermediate holding bin:

```
mov ax, [maxCount] ; ax <-- [maxCount]
mov [count], ax ; [count] <-- ax
```

A Moving Example

Listing 4.1 demonstrates how `mov` works. Assemble, link, and load the program into Turbo Debugger with the commands:

```
tasm /zi mov
tlink /v mov
td mov
```

Listing 4.1. MOV.ASM.

```
1: %TITLE "MOV demonstration -- by Tom Swan"
2:
3:     IDEAL
4:
5:     MODEL    small
6:     STACK   256
7:
8:     DATASEG
9:
10: exCode      DB    0
11: speed       DB    99 ; One-byte variable
12:
13:     CODESEG
14:
15: Start:
16:     mov     ax, @data ; Initialize DS to address
17:     mov     ds, ax ; of data segment
18:
```

```

19:      mov    ax, 1           ; Move immediate data into
20:      mov    bx, 2           ; registers
21:      mov    cx, 3
22:      mov    dx, 4
23:
24:      mov    ah, [speed]     ; Load value of speed into ah
25:      mov    si, offset speed ; Load address of speed into si
26:
27: Exit:
28:      mov    ah, 04Ch        ; DOS function: Exit program
29:      mov    al, [exCode]    ; Return exit code value
30:      int    21h            ; Call DOS. Terminate program
31:
32:      END    Start          ; End of program / entry point

```

Running MOV in Turbo Debugger

You should now have the MOV program loaded into Turbo Debugger. Follow these numbered steps for a few experiments that will help you to understand what the instructions do:

1. Press Alt-V-C to open the CPU window and press F5 to zoom the window to full screen. Because the CPU window shows many important details on one display—the stack, registers, flags, memory, and instructions—this is the window you should use to run most assembly language programs in this book.
2. Press F8 to run the program a single step (instruction) at a time as you read the following descriptions. (Line numbers reference each line from Listing 4.1.)
3. Lines 16–17 initialize the `ds` segment register, first assigning to `ax` the predefined value `@data` and then assigning this value to `ds`. (You can assign only values from a general-purpose register, a memory variable, or the stack to a segment register—you can't directly assign literal values to segment registers.)
4. Executing lines 19–22 assigns literal values 1, 2, 3, and 4 to the general-purpose registers `ax`, `bx`, `cx`, and `dx`. Stop pressing F8 when Turbo Debugger's instruction arrow (to the right of the addresses such as `cs:0011`) points to the `mov ah, [speed]` instruction. (If you accidentally go too far, press Ctrl-F2 to reset and then press F8 until you get back to the right spot.)
5. The `mov ah, [speed]` instruction at line 24 loads the value stored at the location addressed by `speed` into the 8-bit register half `ah`. Near the top of the display in the double-line border, look for the text that reads `ds:0001 = 63`. This tells you the value in hexadecimal (63) that is about to be loaded into `ah`. The `ds:0001` notation indicates the address at which this value is stored. Like all addresses, the address has two components: a segment value (held by register `ds`) and an offset 0001.
6. Press F8 to execute the instruction at line 24 and watch the value of the `ax` register change in the upper-right corner of the display. Notice that the `ds:0001=63` is now gone. To see this again, use the up and down arrow keys to move the highlighted

bar up and down. You can always move the bar to any individual instruction to see the effect of values about to be loaded into registers or written to memory.

7. Find register `si` near the upper-right third of the CPU window. Press F8 again, executing the instruction at line 25, `mov si, offset speed`. As you can see, this instruction sets register `si` to 0001, the offset value of the address in the previous step. The `OFFSET` keyword in the `mov` instruction tells the assembler you intend to use the offset address of a label. (`OFFSET` may be in lowercase—`offset`—on your screen.)
8. Continue to press F8 until the program ends. Lines 28–30 perform three steps that end every EXE program. First, the value of the DOS exit operation (04Ch) is loaded into `ah`. Then, `a1` is assigned the contents of variable `exCode`, which a program can pass back to DOS as an error indicator. A zero value means no error. The `int 21h` instruction at line 30 calls DOS with these parameters in `ah` and `a1`, ending the program.
9. Press Esc followed by Alt-X to quit Turbo Debugger.

NOTE

The lowercase *h* at the end of values such as 21h and 04Ch tells Turbo Assembler that these values are expressed in hexadecimal, always beginning with decimal digits. In other words, you cannot write FFFh. Instead, you must write OFFh.

Stacking the Deck

A stack is a special segment of memory that operates in conjunction with several 8086 instructions. As with all segments, the location of the stack and its size (up to 64K) are up to you and your program to determine. In assembly language programs, the easiest way to create a stack is to use the `STACK` directive, as in most example programs in this book. If you don't create a stack, you'll receive a warning from Turbo Linker. A stack has three main purposes:

- To preserve register values temporarily
- To store addresses to which subroutines return
- To store dynamic variables

The last of these comes into play more often in high-level language programming, where variables are passed via the stack to and from functions and procedures. Similarly, temporary variables may be stored on the stack. These uses are rare in pure assembly language programming, although you can certainly store variables in stack memory this way if you want.

How Stacks Operate

Conceptually, a stack is like a spring-loaded bin of dishes in a restaurant kitchen. The top dish on the stack is readily available, but to get to the dishes below, other dishes above must first be removed. Placing a new dish on the top of the stack is called a *push*. Removing a dish from the top of the stack, causing other dishes below to move up a notch, is called a *pop*. Because of the way the last dishes pushed onto the stack are the first dishes to be popped, this kind of a stack is called a LIFO stack, for “Last-In-First-Out.”

Unlike dishes, values in computer memory can’t physically move up and down. Therefore, to simulate the action of a moving stack of values requires using registers to locate the base address of the stack and the offset address of the top dish—that is, the location where the top value of the stack is stored. In 8086 programming, segment register *ss* addresses the stack segment base. Register *sp* addresses the top of stack offset in that segment.

Figure 4.4 illustrates how a small stack of 12 bytes appears in memory. Register *ss* addresses the base of the stack at segment address 0F00. Register *sp* addresses offsets from this starting address, ranging from 0000 to 000A. The last byte in the stack is at offset 000B (in the figure, just to the right of the byte at 000A). Items in the stack occupy 2-byte words. The program that prepares this stack would declare a `STACK 12` and let the assembler, linker, and DOS calculate exactly where in memory the stack will be stored. You don’t have to initialize registers *ss* and *sp*. DOS does that for you when it loads your assembled program. In the figure, *sp1* shows where *sp* points when the program begins running. Notice that the logical address in `ss:sp` points to the byte *below* the last byte in the stack.

NOTE

Because the bottom of an 8086 stack is at a higher memory address than the top of the stack, terms such as “bottom,” “above,” and “below” can be confusing. Because these terms are so common when discussing stacks, there’s nothing to do but live with the ambiguities. Just remember that in memory, stacks grow toward lower memory addresses and shrink toward higher ground.

Refer again to Figure 4.4. Several actions occur if you execute these instructions:

```
mov ax, 100
push ax          ; sp2
mov bx, 200
push bx         ; sp3
```

The push instruction performs two steps:

1. 2 is subtracted from *sp*.
2. The specified register value is copied to `[ss:sp]`.

Figure 4.4.
The stack segment.

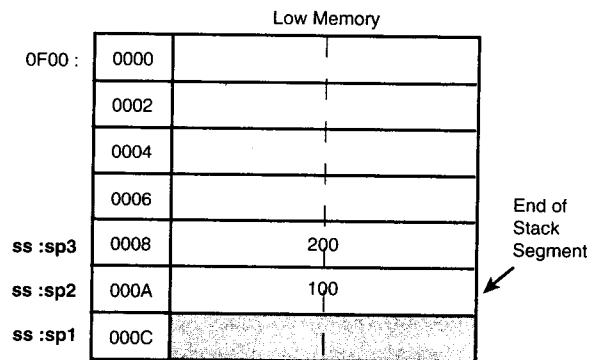

The order of these steps is important. A push first subtracts 2 (not 1) from *sp*. In Figure 4.4, the first such push leaves *sp* at *sp2*, where the value of register *ax* is then stored. Notice that this action leaves the stack pointer addressing the most recently pushed word value on the stack.

NOTE

Become familiar with the notation `[ss:sp]`, which refers to the contents at the offset of *sp* inside the stack segment. Remember that the brackets refer to the value in memory at a specified address.

A Stack Demo

You can use Turbo Debugger to watch a stack in action—a great way to learn how stacks operate. For this purpose, use Listing 4.2, which demonstrates one of the stack's most common uses—to preserve register values. Assemble, link, and load the program into Turbo Debugger with the commands:

```
tasm /zi pushpop
tLink /v pushpop
td pushpop
```

After the listing are step-by-step instructions for running the program under the control of Turbo Debugger.

Listing 4.2. PUSHPOP.ASM.

```
1: %TITLE "PUSH/POP demonstration -- by Tom Swan"
2:
3:     IDEAL
4:
5:     MODEL    small
6:     STACK   256
7:
8:     DATASEG
9:
10:  exCode      DB      0
11:
12:     CODESEG
13:
14:  Start:
15:     mov     ax, @data      ; Initialize DS to address
16:     mov     ds, ax        ; of data segment
17:
18:     push   ax             ; Save ax and bx
19:     push   bx             ; on the stack
20:
21:     mov     ax, -1        ; Assign test values
22:     mov     bx, -2
23:     mov     cx, 0
24:     mov     dx, 0
25:
26:     push   ax             ; Push ax onto stack
27:     push   bx             ; Push bx onto stack
28:     pop    cx             ; Pop cx from stack
29:     pop    dx             ; Pop dx from stack
30:
31:     pop    bx             ; Restore saved ax and bx
32:     pop    ax             ; values from stack
33:
34:  Exit:
35:     mov     ah, 04Ch      ; DOS function: Exit program
36:     mov     al, [exCode]  ; Return exit code value
37:     int     21h          ; Call DOS. Terminate program
38:
39:     END /   Start       ; End of program / entry point
```

Running the PUSHPOP Demo

You should have PUSHPOP running in Turbo Debugger. Follow these steps to see a stack in action:

1. Open and zoom the CPU window with Alt-V-C and F5. Press F8 twice, stepping to line 18. Note the values of the ax and bx registers.
2. Watch the stack values in the lower-right corner—the window with addresses that begin with ss:. Press F8 once to push the value of ax onto the stack. Press F8 again to push the value of bx. The top of the stack is marked with an arrow at the bottom

of the window. (Only Turbo Debugger's designers know why the "top" of the stack appears at the "bottom" of this window. I told you such terms tend to be confusing.)

3. Press F8 four times, executing lines 21–24 and loading registers `ax`, `bx`, `cx`, and `dx` with test values.
4. Press F8 again to execute line 26, pushing the value of `ax` onto the stack. Observe the stack's contents and the value of `sp` before and after the push. Press F8 once more to push `bx`.
5. Lines 28 and 29 pop the stack, removing the value at `[ss:sp]` and adding 2 to `sp`, addressing the next word. Press F8 twice to execute the two lines. Notice that you can pop values from the stack into registers other than the ones you pushed earlier.
6. Press F8 twice again to execute lines 31–32. These instructions restore the values of `bx` and `ax` to the values they had before executing lines 18–19.
7. Quit Turbo Debugger with Alt-X. You don't have to run the program to its completion.

Stack Management

The goal of good stack management is simple: For every push in a program, there must be a balancing pop. Matching your pops and pushes keeps the stack pointer right—in other words, in synch with the program's ability to store and retrieve the values it needs.

NOTE

There are exceptions to the rule that every push must be balanced with a pop. For example, you can add and subtract values from `sp`, perhaps to reserve stack space for storing temporary values. And you can end a program with DOS function 4C even if the stack is not in synch. But in general, try to keep the stack in a known state at all times. Careless stack management is one of the leading causes of serious bugs.

Consider what happens if you fail to execute a matching pop for every push. In this case, future pushes will cause the stack to grow larger and larger, eventually overflowing the segment space allotted by your program. This serious error usually results in a crash as areas in memory are overwritten by the runaway stack pointer. A similar error occurs if you execute more pops than pushes, causing a stack underflow and also usually resulting in a crash.

A good way to prevent such problems is to write your programs in small modules, or sub-routines. In each module, push onto the stack all the registers you plan to use. Then, just before this section of code ends, pop the same registers off the stack but in the reverse order.

For example, here's how you might construct a typical section:

```
push ax          ; Save ax, bx, dx on the stack
push bx
push dx

; ---- Programming goes here

pop dx          ; Restore dx, bx, ax from the stack
pop bx
pop ax
```

Presumably, the instructions between the push and pop instructions will use ax, bx, and dx; therefore, these registers are pushed onto the stack to preserve the register values. Later, the same registers are popped from the stack in reverse order, restoring the original register values and keeping the stack in synch. Recalling the analogy of the stack of dishes, you can see that popping in reverse order is necessary to restore the previously saved values to the correct registers. The last value pushed onto the stack (dx) is the first to be removed, while the first dish pushed (ax) is the last to be popped.

NOTE

After popping a value from the stack, don't attempt to subtract 2 from sp and reread that same value in the future. This is always illegal, even though you may notice while viewing the stack in Turbo Debugger that the popped values appear to remain in the stack memory at address offsets lower than sp. Only the values located from sp to the bottom of the stack are guaranteed to be preserved. All other values in the stack segment are subject to being overwritten, possibly by DOS and, even more likely, by interrupts that run concurrently with your program. (Chapter 10 explains more about interrupts and stack handling.) Breaking this rule is a sure way to break your code. Don't do it!

Exchanging Data

Let's examine another instruction from Table 4.2, xchg, which swaps two register values or a register value and a byte or word stored in memory. Suppose you want to exchange the values in dx and ax. With xchg, you simply write:

```
xchg ax, dx      ; ax <- dx; dx <- ax
```

Even though Table 4.2 lists source and destination operands for xchg, the order of operands doesn't matter as the instruction swaps the value of one operand with the other. Without

xchg, swapping two registers requires either a push onto the stack or a third register. For example, here's a less efficient method to exchange two 16-bit registers using the stack as an intermediate way station for one value:

```
push ax      ; stack <- ax
mov ax, dx   ; ax <- dx
pop dx       ; dx <- stack (original ax)
```

Swapping two 8-bit values takes a third register because you can't push bytes onto the stack—you can push and pop only 16-bit words. Without xchg, to swap two bytes in al and ah, you could write:

```
mov bh, ah   ; bh <- ah
mov ah, al   ; ah <- al
mov al, bh   ; al <- bh
```

Of course, with xchg, none of this is necessary. (It is instructive to understand how the stack and other registers can be used this way, however.) In addition to swapping register values, xchg can also swap the value in a register with a value stored in memory. Here are two examples:

```
xchg ax, [things] ; ax <--> [things]
xchg [oldCount], cx ; cx <--> [oldCount]
```

The first line swaps the value of ax with the value stored at things. The second line swaps cx and oldCount. Again, the order of operands is unimportant.

NOTE

Exchanging full 16-bit register values when one of those registers is the accumulator ax executes a tiny bit faster than instructions that exchange other registers. Turbo Assembler correctly assembles instructions such as xchg ax, bx and xchg cx, ax into fast, single-byte machine-code instructions. Other exchanges that don't involve ax take 2 bytes of machine code. Be aware that all assemblers are not as smart as Turbo. For example, the assembler in DOS DEBUG requires ax to be specified last to generate the single-byte machine-code form. Also, pure register exchanges are many times faster than exchanges between registers and values in memory. Paying attention to small details like these will help you to squeeze extra speed from your code.

Arithmetic Instructions

Most computers are great at math; therefore, it may come as a surprise that assembly language has only a few relatively primitive math operators. There is no exponentiation symbol, no floating point, no square root, and no SIN and COS functions built into the 8086

instruction set. Mathematics instructions in assembly language are restricted to adding, multiplying, dividing, and subtracting signed and unsigned binary integer values. Table 4.3 lists the 8086 math instructions.

There are two ways to increase the math power of assembly language programming. First, you can purchase (or write) a math package with routines that implement the high-level functions you need. Another solution is to purchase a math coprocessor chip for your PC, although this can be expensive if your computer has an 80286 or 80386 processor, which requires a complementary 80287 or 80387 math chip. The 80486 processor contains the built-in equivalent of an 80387 math chip. Third, and probably best, is to use a high-level language such as Turbo Pascal or Turbo C to code your floating-point expressions. These languages come with automatic detectors to sniff out the presence of a math coprocessor, and can switch to a software emulator for systems lacking the optional chip. After writing your program, you can combine the compiled high-level code with your assembly language program (see Chapters 12 and 13). Because math coprocessors have strict requirements about data and instruction formats, most compilers generate optimized machine code, and there's little advantage to writing floating-point expressions directly in assembly language.

But don't take this as a negative pronouncement on assembly language math. Even without a math library or coprocessor, you can do plenty with the 8086's built-in integer instructions. In fact, most programs get along just fine without any higher math capabilities. You certainly don't need floating-point numbers to total the bytes in a disk directory or to count the number of words in a text file. For these and other operations, integer math is more than adequate. In pure assembly language, such jobs frequently run more quickly than equivalent code of compiled high-level languages.

Table 4.3. 8086 Arithmetic Instructions.

<i>Mnemonic/Operands</i>	<i>Description</i>
Addition Instructions	
aaa	ASCII adjust for addition
adc <i>destination, source</i>	Add with carry
add <i>destination, source</i>	Add bytes or words
daa	Decimal adjust for addition
inc <i>destination</i>	Increment
Subtraction Instructions	
aas	ASCII adjust for subtraction
cmp <i>destination, source</i>	Compare
das	Decimal adjust for subtraction

continues

Table 4.3. continued

<i>Mnemonic/Operands</i>	<i>Description</i>
Subtraction Instructions	
<code>dec destination</code>	Decrement byte or word
<code>neg destination</code>	Negate (two's complement)
<code>sbb destination, source</code>	Subtract with borrow
<code>sub destination, source</code>	Subtract
Multiplication Instructions	
<code>aam</code>	ASCII adjust for multiply
<code>imul source</code>	Integer multiply
<code>mul source</code>	Multiply
Division Instructions	
<code>aad</code>	ASCII adjust for division
<code>cbw</code>	Convert byte to word
<code>cwd</code>	Convert word to doubleword
<code>div source</code>	Divide
<code>idiv source</code>	Integer divide

Addition Instructions

Table 4.3 lists five addition instructions. Two of these, `add` and `adc`, sum 2 bytes or words. `inc` (increment) is a fast instruction to add 1 to a register or value in memory. (The other two instructions, `aaa` and `daa`, make adjustments to values stored in *binary-coded-decimal* format, which you'll meet again later on.) To add an 8-bit value in `ah` to the 8-bit value in `bh`, you can write:

```
add ah, bh      ; ah <- ah + bh
```

As with `mov`, the `add` instruction requires source and destination operands. The instruction sums these two values and stores the result in the specified destination, replacing the original value. In this example, the result is stored in `ah`. The `adc` instruction operates similarly but adds in the value of the carry flag `cf` to the result:

```
adc ah, bh      ; ah <- ah + bh + cf
```

If `cf` equals 1, the result is the same as adding 1 to the sum of `ah` and `bh`. After a previous `add` operation, `cf` is set to 1 if an overflow occurred; therefore, `adc` is most often used after an

initial `add` when summing multibyte values, picking up the possible carries while individually adding each byte in turn. Although you can add words directly, you could use these instructions to add the individual bytes of a 16-bit value stored at `sum` to register `ax`. These instructions double the word at `sum`;

```
mov ax, [word sum]    ; Set ax to value of [sum]
add al, [byte sum]    ; Add LSBs
adc ah, [byte sum + 1] ; Add MSBs with possible carry
mov [word sum], ax    ; Store value back in memory
```

Remember that words are stored in byte-swapped order. In this sample, the first line loads the word value into `ax`. The second line adds the least significant bytes together, storing the result in `al` and setting `cf` to 1 if the addition generates a carry. The third line adds this possible carry to the sum of the most significant bytes. Finally, the fourth line stores the final result back in memory. Because the 8086 can manipulate word values directly, you can perform this same addition with the simpler instructions:

```
mov ax, [word sum]    ; Set ax to value of [sum]
add [word sum], ax    ; Add [sum] to itself
```

You must load `[sum]` into a register before adding because `add` cannot directly add two values stored in memory—at least one register must be specified. Notice that in these examples the word and byte operators tell the assembler what kind of data `sum` addresses. In some cases, the assembler can figure this out on its own. In others, you need to use the operators. There's no harm in using them, however. (Chapter 5 explains data formats and operators in more detail.)

Both `add` and `adc` can add immediate (literal) values to registers and values in memory. For example, this adds 5 to the current value of `bx`, storing the result in `bx`:

```
add bx, 5             ; bx <- bx + 5
```

When you need to add only 1 to a value, use `inc` instead of `add`—it's faster. Notice from Table 4.3 that `inc` requires only one operand. The following instructions increment four general purpose registers by 1:

```
inc ax                ; ax <- ax + 1
inc bx                ; bx <- bx + 1
inc cx                ; cx <- cx + 1
inc dh                ; dh <- dh + 1
```

The last of these samples increments `dh`, leaving the value of `d1` alone. The other three samples increment the full 16-bit registers specified. Remember that you can operate on either of a general-purpose register's 8-bit halves without affecting the other half.

Subtraction Instructions

Subtracting in assembly language is similar in form to adding. The `sub` instruction subtracts two byte or word values. The `sbb` instruction does the same but takes into account a possible

borrow from a previous subtraction of multibyte or multiword values. An example shows how to subtract `bx` from `ax` and store the result in `ax`:

```
sub ax, bx           ; ax <- ax - bx
```

As with `add` and `adc`, you can subtract two registers or a register and a value stored in memory. You can also subtract immediate values. You should be able to understand the following samples by reading the comments to the right of each line:

```
sub cx, 5           ; cx <- cx - 5
sub dx, [score]    ; dx <- dx - [score]
sub [answer], 3    ; [answer] <- [answer] - 3
sub ax, 1          ; ax <- ax - 1
```

You can replace the last of these samples with the faster `dec` instruction, which decrements by 1 a register or value in memory. You can decrement byte and word values, as these samples show:

```
dec ax             ; ax <- ax - 1
dec dl            ; dl <- dl - 1
dec si            ; si <- si - 1
dec [balance]    ; [balance] <- [balance] - 1
```

Add and Subtract Demonstration

Listing 4.3 demonstrates the four instructions `add`, `sub`, `inc`, and `dec`. Assemble, link, and run the program under control of Turbo Debugger with the instructions:

```
tasm /zi addsub
tlink /v addsub
td addsub
```

Listing 4.3. ADDSUB.ASM.

```
1: %TITLE "ADD, SUB, INC, DEC demo -- by Tom Swan"
2:
3:         IDEAL
4:
5:         MODEL    small
6:         STACK   256
7:
8:         DATASEG
9:
10: exCode          DB      0
11: count           DW      1
12:
13:         CODESEG
14:
15: Start:
16:         mov     ax, @data      ; Initialize DS to address
17:         mov     ds, ax        ; of data segment
18:
```

```

19:      mov     ax, 4
20:      mov     bx, 2
21:      add     ax, bx           ; ax <- ax + bx
22:
23:      mov     cx, 8
24:      add     cx, [count]     ; cx <- cx + [count]
25:
26:      add     [count], cx     ; [count] <- cx + [count]
27:
28:      inc     [count]         ; [count] <- [count] + 1
29:      dec     [count]         ; [count] <- [count] - 1
30:      inc     ax              ; ax <- ax + 1
31:      dec     cx              ; cx <- cx + 1
32:
33: Exit:
34:      mov     ah, 04Ch        ; DOS function: Exit program
35:      mov     al, [exCode]    ; Return exit code value
36:      int     21h            ; Call DOS. Terminate program
37:
38:      END     Start          ; End of program / entry point

```

Running the ADDSUB Demo

Press Alt-V-C and F5 to view the CPU window. Watch the register values change as you single step through the program by pressing F8 while reading the following descriptions. Try to predict register and memory values before executing each instruction.

Lines 19–21 show how to add the values in two registers `ax` and `bx`, storing the result in `ax`. Try changing the initial values (4 and 2) and rerun the program. Lines 23–26 add register `cx` and variable `[count]` together. Notice that you can store the result in a register (line 24) or back in memory (line 26). To experiment with `sub`, make a backup copy of `ADDSUB.ASM`, and then change all `add` instructions to `sub`, reassemble, link, and run under Turbo Debugger's control.

Lines 28–31 demonstrate how `inc` and `dec` increment and decrement variables and register values. To see the values in memory change, watch the upper middle of Turbo Debugger's CPU window. You should see the value stored at `[count]`. Unfortunately, after executing line 29, this value disappears (because the next instruction makes no reference to `count`'s location). The next section explains a method to make watching variables easier.

NOTE

Quit Turbo Debugger now with the command Alt-X.

Watching Out for Number One

Turbo Debugger has a “watch window” for viewing variables. As you execute instructions that change values in memory, the values listed in the watch window also change. This makes it easy to observe the effects of executing assembly language instructions that operate on variables. Load Listing 4.3 with the command `td addsub`, but don’t open the CPU window just yet. Then follow these steps to inspect the value of `count` (line 11):

1. Press Ctrl-F7, type `count`, and press Enter. Turbo Debugger locates the `count` variable in memory and shows `count`'s initial value in the watch window at the bottom of the display.
2. Press F8 until reaching line 26 (`add [count], cx`). Then press F8 again and watch the value of `count` in the watch window change.

NOTE

With the CPU window visible, you can also watch variables using these same techniques, but to make the watch window visible, you might have to press F6 several times or press Alt-2.

When running other example programs in this book, you can add variable names to the watch window. Also, there are other ways to view memory with Turbo Debugger—for example, the bottom-left corner of the CPU window shows successive bytes from any starting location. But the watch window is easy to use and has the advantage of showing variables by name. Even better, you can change the values of variables without having to reassemble the program. To try this, press Ctrl-F2 to reload `ADDSUB` (or start Turbo Debugger with `td addsub`) and follow these steps:

1. Press F6 until the watch window borders change to double lines, indicating this window is active. Type `count` and press Enter. This demonstrates another way to enter variable names to watch. (If `count` is already in the window, you can skip this step.)
2. Press Ctrl-C (the watch window’s Change command) and enter a new value for `count`. Instead of `count`'s initial value (1) as listed in the program (line 11), the program now begins with your new `count` value.
3. Step through the program with F8. The instructions use the new `count` value. Press Ctrl-F2 to reload the program, use F6 to make the watch window active if necessary, and enter new values for `count` until you’re familiar with this option.

These Turbo Debugger commands save time by giving you the ability to change variable values and run test programs without having to reassemble your code. When changing variable values, you can enter new numbers in hexadecimal, decimal, or binary. In all cases, the

first character must be a decimal digit. The last character can be *d* for decimal, *h* for hexadecimal, or *b* for binary. The default is hexadecimal. Here are a few sample values as you might enter them into the watch window:

```
100      hexadecimal (256 decimal)
0ffh    hexadecimal (255 decimal)
256d    decimal
1001b   binary (9 decimal)
FFh     error--first character must be 0-9
```

Sneaky Subtractions

From Table 4.3, you might think the instructions `neg` and `cmp` are out of place. `Neg` negates a binary value. `Cmp` compares two values. So, what do these instructions have to do with subtraction?

In the case of `neg`, the 8086 processor internally subtracts from 0 the value to be negated. This value might be stored in a register or in memory. Subtracting a value from 0, as you recall, forms the two's complement of that value—identical to toggling all the zeros to ones and the ones to zeros, and then adding 1. In 8086 assembly language, it's simpler just to use `neg` to do the same thing. Here are two samples:

```
neg ax      ; Form two's complement of ax
neg [value] ; Form two's complement of [value]
```

The relation between `cmp` and subtraction is not as obvious—that is, until you understand that most digital processors perform comparisons between two values by subtracting one value from the other and then throwing away the result. The reason for performing comparisons this way is to set various flag bits that indicate the condition of the result—for example, whether the result is zero, negative, or positive. `Cmp` performs a subtraction identically to `sub` but saves only the flag values, which other instructions can inspect. (Later in this chapter when we get to flow-control instructions, this will make more sense.) For now, just remember that a `cmp` is the same as a `sub` with no result, only a possible change to various flags.

Multiplying and Dividing Unsigned Values

Multiplication and division require extra care to perform properly. You must be certain to place values in the correct registers. After the operation, you must be careful to extract the answer from the right places. The best way to learn the ropes is to run an example program in Turbo Debugger and demonstrate how `mul`, `imul`, `div`, and `idiv` operate. Assemble and link Listing 4.4 and load the code into Turbo Debugger with the commands:

```
tasm /zi muldiv
tlink /v muldiv
td muldiv
```

Listing 4.4. MULDIV. ASM.

```

1: %TITLE "MUL, DIV, IMUL, IDIV demo -- by Tom Swan"
2:
3:     IDEAL
4:
5:     MODEL    small
6:     STACK   256
7:
8:     DATASEG
9:
10:  exCode      DB      0
11:  opByte      DB      8
12:  opWord      DW     100
13:  sourceByte  DB     64
14:  sourceWord  DW    4000
15:
16:     CODESEG
17:
18:  Start:
19:      mov     ax, @data      ; Initialize DS to address
20:      mov     ds, ax        ; of data segment
21:
22:      mov     al, [opByte]
23:      mul     [sourceByte]  ; ax <- al * [sourceByte]
24:
25:      mov     ax, [opWord]
26:      mul     [sourceWord]  ; ax,dx <- ax * [sourceWord]
27:
28:      mov     ax, [opWord]
29:      mul     ax             ; ax,dx <- ax * ax
30:
31:      mov     ax, [opWord]
32:      div     [sourceByte]  ; al <- ax div [sourceByte]
33:
34:      mov     ax, [opWord]
35:      mov     dx, [opWord]
36:      div     [sourceWord]  ; ax <- ax,dx div [sourceWord]
37:
38:  Exit:
39:      mov     ah, 04Ch      ; DOS function: Exit program
40:      mov     al, [exCode]  ; Return exit code value
41:      int     21h          ; Call DOS. Terminate program
42:
43:      END     Start       ; End of program / entry point

```

Running the MULDIV Demo

In addition to `exCode`, `MULDIV` declares four test variables at lines 11-14. Add these variable names to Turbo Debugger's watch window. (Quick tip: press F6 and type the variable names.) Then, open the registers window or view the CPU window, whichever you prefer. Press F8 to step through each instruction. To start over, press Ctrl-F2. Experiment with different values as you follow these suggestions:

1. Lines 22–23 multiply two unsigned bytes. One byte must be in register `al`. The other can be in memory, as in this example, or in another 8-bit register. The result of the multiplication is stored in the 16-bit register `ax`. Overflow is not possible as $255 * 255$ equals 65,025—well within the maximum range of a 16-bit word. Prove this to yourself by changing `opByte` and `sourceByte` to `0FFh` and rerun the program.
2. Lines 25–26 are similar but, this time, multiply two 16-bit word values. Two registers, `dx` and `ax`, hold the result, which can be up to 32 bits long. `dx` holds the most significant part of the result; `ax`, the least significant part. As with byte multiplication, overflow cannot occur.
3. Lines 28–29 square the value of a register, multiplying `ax` by itself. You can also square an 8-bit value by multiplying `al` by itself. You can't do this with any other registers—you can use only `ax` and `al`.
4. Lines 31–32 demonstrate unsigned division. The source data to the `div` instruction divides into the 16-bit dividend in `ax`. The whole number quotient is placed in `al` with any remainder in `ah`.
5. Lines 34–36 perform a similar division, this time dividing a 32-bit value in `dx` and `ax` by the 16-bit word value of `sourceWord`. Register `dx` holds the most significant word of the original value, and `ax` holds the least significant word. After the division, the whole number quotient is stored in `ax` with any remainder in `dx`.

NOTE

While experimenting with new values, don't attempt to divide by 0. Doing so causes the processor to generate a signal called the "divide-by-zero" interrupt (see Chapter 10), halting the program. Actually, this condition is misnamed as it can occur any time the result of a division is too large to fit in the specified destination. For example, the "divide-by-zero" interrupt occurs at lines 31–32 when `opword = 0F000h` and `sourcebyte = 1` because `0F000h` is larger than the maximum value that a single byte can express. If this condition occurs while running Turbo Debugger, try resetting with `Ctrl-F2` or quit and reload.

As you can see from these experiments, unsigned multiplication and division is somewhat unfriendly in 8086 assembly language. You must use only the specified registers, and you must be aware that 32-bit results and operands are stored in two registers `dx` and `ax`. The source operand to `mul` and `div` (see lines 23, 26, 29, 32, and 36) can be a memory location as in most of these examples or any general-purpose register. Because the size of the source operand determines the size of the result, you should also be aware that accidentally multiplying a word variable (as in line 26) when you think you are multiplying a byte variable will cause `dx` to change.

Multiplying and Dividing Signed Values

The signed multiply (`imul`) and divide (`idiv`) instructions operate similarly and use the same registers as `mul` and `div`. (The *i* in the mnemonics stands for integer, indicating that signed positive and negative values are allowed.) The only difference is in the range of values allowed:

- Signed bytes range from -128 to $+127$
- Signed words range from $-32,768$ to $32,767$

Try a few experiments by modifying Listing 4.4 to use `imul` in place of `mul` and `idiv` in place of `div`. Enter various positive and negative test values, either by editing lines 11–14 or by typing new values in Turbo Debugger’s watch window. As you will see from your tests, using signed multiplication and division requires some care. If you get stuck, the following notes should help:

- Remember that negative results are in two’s complement notation.
- Any remainder (ah for 8-bit divisions and dx for word divisions) has the same sign as the quotient.
- An interrupt 0 is generated, possibly halting the program, if you attempt to divide by 0 or by any divisor that produces a result larger than the specified destination can hold.

Converting Bytes, Words, and Doublewords

When using signed binary values, you often need to convert an 8-bit byte value to a 16-bit word, perhaps to prepare for a multiplication or division. Because the value may be a negative number in two’s complement notation, this can be tricky as you must take care to preserve the original value and its sign. To make this easy, use `cbw` (convert byte to word) and `cwd` (convert word to doubleword). For an example of how these instructions work, insert the following lines into Listing 4.4, replacing lines 22–36. Assemble and run under control of Turbo Debugger, experimenting with different values for `sourceByte` and `sourceWord`:

```
mov    al,[sourceByte]      ; Load source byte into al
cbw                    ; Extend sign to ax
mov    ax,[sourceWord]     ; Load source word into ax
cwd                    ; Extend sign to dx,ax
```

Try setting `sourceByte` to -3 decimal and executing the first two of these instructions. Before `cbw`, `al` equals hexadecimal `FD`. After, `ax` equals `FFFD`—the same value (-3 decimal) expressed in 16 instead of 8 bits. The `cbw` instruction *extends* the 8-bit value (including the sign) to the 16-bit destination. Similarly, `cwd` extends 16-bit values to 32-bit doublewords. Except for the number of bits involved, the two instructions perform the same job.

When using these instructions, you must observe a few restrictions. The source value for `cbw` must be in `al`. The 16-bit result always appears in `ax`. The source value for `cwd` must be in `ax`.

The 32-bit result always appears in `dx` and `ax`. Normally, you'll use `cbw` and `cwd` along with `imul` and `idiv` when you have byte values to multiply or divide into words. But you're certainly free to use these instructions in other ways, too.

Logic Instructions

Table 4.4 lists the 8086 logic instructions, organized in two subdivisions: Logical and Shift/Rotate instructions. Logical instructions combine bytes and words with AND, OR, and other logical operators. Shift/Rotate instructions shift and rotate bytes and words. These concepts were introduced in Chapter 3.

The simplest logical instruction, `not`, toggles the bits in a byte or word from ones to zeros and from zeros to ones. As you know, this is called the one's complement. (Adding 1 to this result forms the two's complement, although it's much easier to use `neg` for this purpose.) One way to use `not` is to toggle true and false values. If a zero value represents false and a nonzero value represents true, then the following instructions flop register `dh` from true to false and then back to true:

```
mov dh, -1      ; Set dh to true (non zero)
not dh         ; Set dh to "not true," i.e., false
not dh         ; Set dh to "not false," i.e., true
```

Table 4.4. 8086 Logic Instructions.

<i>Mnemonic/Operands</i>	<i>Description</i>
Logical Instructions	
<code>and destination, source</code>	Logical AND
<code>not destination</code>	Logical NOT (one's complement)
<code>or destination, source</code>	Logical OR
<code>test destination, source</code>	Test bits
<code>xor destination, source</code>	Logical Exclusive OR
Shift/Rotate Instructions	
<code>rcl destination, count</code>	Rotate left through carry
<code>rcr destination, count</code>	Rotate right through carry
<code>rol destination, count</code>	Rotate left
<code>ror destination, count</code>	Rotate right
<code>sar destination, count</code>	Shift arithmetic right
<code>shl/sal destination, count</code>	Shift left/arithmetic left
<code>shr destination, count</code>	Shift right

NOTE

Remember that `neg` subtracts a value from 0; `not` toggles the bits in a value on and off—two very different operations. Take care not to confuse the two instructions. A mixup is almost sure to lead to a hard-to-find bug.

Logical Combinations

Chapter 3 explains the ins and outs of the logical AND, OR, and XOR operations on binary values. The 8086 instructions of the same names perform these logical jobs, combining byte and word values according to the rules of the truth tables in Table 3.2. Listing 4.5 demonstrates how the instructions work in assembly language. Assemble, link, and run with Turbo Debugger using the commands:

```
tasm /zi andorxor
tlink /v andorxor
td andorxor
```

Listing 4.5. ANDORXOR.ASM.

```
1: %TITLE "AND, OR, XOR demonstration -- by Tom Swan"
2:
3:     IDEAL
4:
5:     MODEL    small
6:     STACK   256
7:
8:     DATASEG
9:
10: exCode      DB      0
11: sourceWord   DW      0ABh    ; 16-bit source value
12: wordMask     DW      0CFh    ; 16-bit mask
13:
14:     CODESEG
15:
16: Start:
17:     mov     ax, @data        ; Initialize DS to address
18:     mov     ds, ax          ; of data segment
19:
20:     mov     ax, [sourceWord] ; Set ax, bx, cx, and dx
21:     mov     bx, ax          ; to [sourceWord]
22:     mov     cx, ax
23:     mov     dx, ax
24:
25:     and     ax, [wordMask]   ; ax <- ax AND mask
26:
27:     or      bx, [wordMask]   ; bx <- bx OR mask
28:
```

```

29:      xor    cx, [wordMask]    ; cx <- cx XOR mask
30:
31:      xor    dx, dx              ; dx <- 0000
32:
33: Exit:
34:      mov    ah, 04Ch           ; DOS function: Exit program
35:      mov    al, [exCode]       ; Return exit code value
36:      int    21h               ; Call DOS. Terminate program
37:
38:      END    Start              ; End of program / entry point

```

Running the ANDORXOR Demo

With the assembled ANDORXOR program loaded into Turbo Debugger, follow these steps to see the 8086 and, or, and xor instructions in action:

1. Open Turbo Debugger's CPU window (Alt-V-C) and zoom to full screen (F5).
2. Watch (Ctrl-F7) variables sourceWord and wordMask to make it easy to enter new test values. Press F6 if necessary to bring the watch window into view.
3. Press F8 to step through the program, stopping after executing the xor instruction in line 31. Try to predict the results of the and, or, and xor instructions in lines 25-29, comparing your predictions with the register values ax for and, bx for or, and cx for xor.
4. To experiment with new test values, press Ctrl-F2 to reset the program. Then, with the watch window active, position the selector bar on the variable you want to change and press Ctrl-C. Enter a new value and press Enter. Then repeat from step 3.

The xor instruction in line 31 of Listing 4.5 sets register dx to 0, a frequently used trick in 8086 programming. Try line 31 with different test values in dx to prove that this line always produces a zero result.

Testing 0001 0010 0011

ANDing two bits produces 1 only if both bits equal 1; therefore, the and instruction is often used to test whether one or more bits equal 1 in a byte or word value. For example, if you need to determine whether bit 2 is set, you can use a mask of 4:

```

0011 0111 (Value to test)
0000 0100 (AND mask)
0000 0100 (Result)

```

If the result equals 0, then bit 2 in the original value must be 0. If the result does not equal 0 as in this sample, then bit 2 of the original value must equal 1. Unfortunately, the and

instruction destroys the original value in the process. To perform this operation while preserving the test value—perhaps to test several single bits in succession without having to reload a register—use the test instruction instead of and:

```

mov ah, [testValue]    ; Load [testValue] into ah
test ah, 04h          ; Test if bit 2 is set

;-----take action here on bit 2

mov dh, 80h           ; Load mask into dh
test ah, dh           ; Test if masked bit is set

;-----take action here on bit 7

test ah, [testBit]    ; Test bit with variable mask

;-----take action on the test bit

```

As these samples show, you can test literal (also called *immediate*) values such as 04h and 80h, values in registers, or values in memory. Test performs a logical and on the operands but throws away the result, leaving the destination operand unchanged but setting the flags exactly the same as and. After the test instruction, you would normally use a jump instruction (explained later) to take an appropriate action based on the test result. Note the similarity between test and cmp, which performs a subtraction but throws out the result. The test instruction performs an and but throws out the result.

Shifting Bits Around

Several shift-and-rotate instructions are available in the 8086 instruction set. As Table 4.4 shows, there are instructions to shift bits left and right and to rotate values through the carry flag cf. The instructions further divide into four subgroups:

- Plain shifts (shl, shr)
- Plain rotations (rol, ror)
- Rotations through cf (rc1, rcr)
- Arithmetic shifts (sal, sar)

Each of these groups follows a different rule for shifting the bits in bytes and words left or right. Despite their subtle differences, the instructions take the same number and types of operands. Once you learn how to use one, you know how to use them all. Let's use the most common shift shl for demonstration. It specifies a register or memory location plus a count, *n*:

```
shl ax, n    ; Shift ax left by n = 1 bits
```

Strangely enough, n must equal 1, or you'll receive an error. (On later-model processors such as the 80386, n may be an unsigned 8-bit constant.) The only legal form of this kind of shift in 8086 assembly language is:

```
shl ax, 1 ; Shift ax left by 1 bit
```

To shift values by more than 1 bit at a time on the 8086 requires two steps: first load a count value into `cl`, and then specify `cl` as the second operand to the shift instruction:

```
mov cl, 5 ; Load count into cl
shl ax, cl ; Shift ax left by cl bits
```

You must use `cl` for this—no other register will work as the second operand. You can also shift memory locations and 8-bit register halves. For example:

```
mov cl, 2 ; Load count into cl
shl bh, cl ; Shift bh left by cl bits
shl [seconds], 1 ; Shift [seconds] left by one bit
shl [minutes], cl ; Shift [minutes] left by cl bits
```

A few experiments and diagrams will clarify the differences between the various shift instructions. Use the following commands to assemble and run Listing 4.6 with Turbo Debugger:

```
tasm /zi shift
tlink /v shift
td shift
```

Listing 4.6. SHIFT.ASM.

```
1: %TITLE "Shift instruction demonstration -- by Tom Swan"
2:
3:         IDEAL
4:
5:         MODEL    small
6:         STACK    256
7:
8:         DATASEG
9:
10: exCode      DB      0
11: operand     DB      0AAh
12:
13:         CODESEG
14:
15: Start:
16:         mov     ax, @data ; Initialize DS to address
17:         mov     ds, ax    ; of data segment
18:
```

continues

Listing 4.6. continued

```

19:      shl     [operand], 1    ; Shift left
20:      shr     [operand], 1    ; Shift right
21:      rol     [operand], 1    ; Rotate left
22:      ror     [operand], 1    ; Rotate right
23:      rcl     [operand], 1    ; Rotate left through carry
24:      rcr     [operand], 1    ; Rotate right through carry
25:      sal     [operand], 1    ; Shift arithmetic left
26:      sar     [operand], 1    ; Shift arithmetic right
27:
28: Exit:
29:      mov     ah, 04Ch         ; DOS function: Exit program
30:      mov     al, [exCode]     ; Return exit code value
31:      int     21h             ; Call DOS. Terminate program
32:
33:      END     Start          ; End of program / entry point

```

Running the SHIFT Demo

The following steps assume you have assembled SHIFT.ASM and loaded the program into Turbo Debugger. These experiments will help clarify several tricky points about the 8086 shift instructions:

1. Listing 4.6 executes each of the seven 8086 shift instructions from Table 4.4. For reasons I'll explain later, `shl` and `sal` are two names for the identical instruction; therefore, although there are eight shift mnemonics, there are only seven actual shift instructions.
2. Figure 4.5 illustrates how the plain shift instructions `shl` and `shr` operate. Step through (F8) lines 19–20 to experiment with these. Each bit in the destination operand shifts one or `cl` positions to the left or right. For `shl`, bit 7 (MSD) moves into the carry flag (`cf`), while a 0 bit shifts in from the right. For `shr`, bit 0 (the LSD) moves into the carry flag, while a 0 bit shifts in from the left.

NOTE

Although Figures 4.5 through 4.8 show only 8-bit bytes, all shift instructions can operate on 16-bit values, too. For this reason, bit numbers are not shown in these diagrams.

3. Figure 4.6 shows how the rotation instructions `rol` and `ror` differ from plain shifts. They do not shift a 0 bit in from the right or left; instead, the MSD and LSD values rotate around to the opposite end. The other bits shift in the indicated direction. With `rol`, the original MSD rotates around to become the new LSD. With `ror`, the original LSD rotates around to the MSD position. These *same* bits also move into the carry flag, just as they do with `shl` and `shr`. Step through lines 21–22 to experiment with these instructions.

- Figure 4.7 illustrates the rotate-through carry instructions, `rc1` and `rcr`. For both of these instructions, the 1-bit carry flag serves as an extension to the register or memory location being rotated. With `rc1`, the MSD shifts into the carry flag while the old carry flag value moves into the LSD position. With `rcr`, the LSD shifts into the carry flag while the old carry flag moves into the MSD position. The other bits shift in the indicated direction. Step through lines 23–24 to experiment with `rc1` and `rcr`.
- Figure 4.8 illustrates the final shift instruction `sar`, which is a strange bird. `sar` operates identically to `shr` except that the MSD retains its original value. Additionally, the MSD is copied to the bit on the right. This is easier to see with a few example binary values:

```

10001000
11000100
11100010
11110001
11111000
    
```

Figure 4.5.
The `shl/sal` and `shr` plain shift instructions.

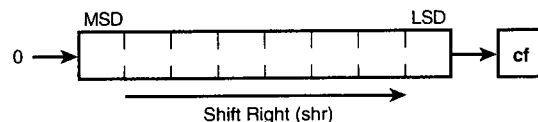

Figure 4.6.
The `rol` and `ror` rotate instructions.

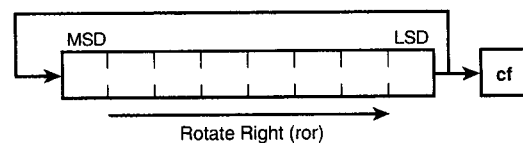
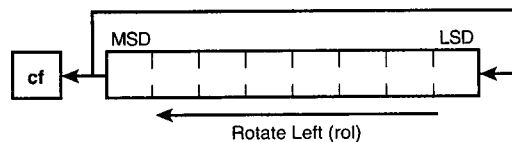

Figure 4.7.
The *rc1* and *rcr* rotate-through-carry instructions.

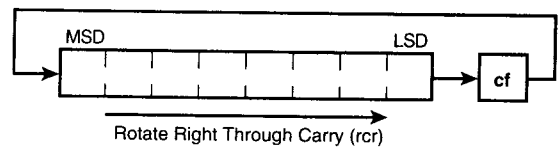
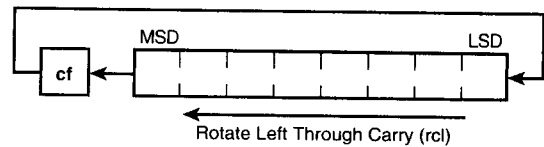
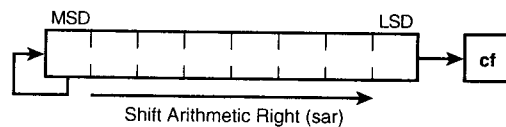

Figure 4.8.
The *sar* instruction.



Starting with the second value, each successive line shows the result of applying *sar* to the value above. The bits shift right just as with *shr*, but the MSD retains its value and is copied to the right. As a result, *sar* is useful for dividing two's complement negative numbers by powers of 2. For example, expressed in hexadecimal, successive *sar* instructions produce this sequence:

8000	-32768
C000	-16384
E000	-8192
F000	-4096
F800	-2048
:	
:	
FFFE	-2
FFFF	-1

Additional *sar* instructions have no effect on hexadecimal FFFF—unlike *idiv*, which if used to divide -1 by 2, gives 0, as you'd expect.

Unlike other shift-instruction pairs that match a right shift with a similar left shift, *sar* does not have a left-handed partner. Instead, the *shl* instruction is given a second mnemonic *sal*, making up for the deficiency. The reason that an arithmetic shift left is no different from a

logical shift left is evident by examining the previous hexadecimal sequence in reverse. If we work from the bottom up, these are the same values that applying `shl` would produce. (Try converting the hex values to binary if you have trouble visualizing this.) In a nutshell, `sar` is already balanced by `shl/sar`, which can multiply negative two's complement values by powers of 2, and there's no need for a separate instruction.

NOTE

When viewing `sal` instructions in Turbo Debugger, some of the CPU window options display this instruction as `shl`. This happens because the debugger can't know the context in which you are using one or the other mnemonic; therefore, it displays the more common name.

Why Shift?

There are many reasons for programs to employ shift instructions, although two reasons stand out:

- To move bits into specific positions
- To multiply and divide by powers of 2

Moving bits into specific positions and then using logical operators to pack the shifted result into other values is a typical assembly language operation. For example, suppose `dh` initially equals 3, `d1` equals 5, and the program requires these two numbers to be packed into `dh` with the 3 in the most significant bits and the 5 in the least significant portion of the byte. Here's how you might proceed:

```
mov dh, 3    ; dh <- 3
mov d1, 5    ; d1 <- 5
mov cl, 4    ; Load count into cl
shl dh, cl   ; Shift dh left four bits
or dh, d1    ; dh <- dh OR d1
```

NOTE

If you have trouble following the logic of this example, replace lines 19–26 in Listing 4.6 with these five instructions and run the program in Turbo Debugger. Watch register `dh` as you single step through each line. The `shl` instruction shifts `dh` left 4 bits, moving the lower 4-bit value to the upper position and shifting in zeros from the right. Then the `or` instruction combines the shifted value with `d1`, packing the two 4-bit values into one 8-bit byte.

Shifty Multiplies and Divides

A useful technique to know is how to multiply and divide by powers of 2 using only shift instructions. (You learned the basics of this in Chapter 3.) Most of the time, shifts are much faster than `mul`, `imul`, `div`, and `idiv` instructions; therefore, you should always use shifts when appropriate. To multiply a value by 8 (or 2^3), for example, you need only to shift that value left 3 times:

```
mov ax, 6      ; ax ← 6
mov cl, 3      ; Load count into cl
shl ax, cl     ; ax ← ax * 8
```

Or to divide by 16 (2^4), shift right 4 times:

```
mov cl, 4      ; Load count into cl
shr ax, cl     ; ax ← ax / 16
```

One problem with multiplication is the possibility of overflow, ignored in these samples. If the carry flag equals 1 after a `shl` by 1, then the result is too large to fit in the destination register or memory location. Overflows from shifting by more than 1 are difficult to detect. Also, with division, any remainder is lost—dividing 2 into 3 by shifting 3 right equals 1, and the remainder is nowhere to be found.

Flow-Control Instructions

Table 4.5 lists the 8086 flow-control or *jump* instructions, those that allow programs to change the address of the machine code to be executed next. Without flow-control instructions, a program would simply start at the top and run at breakneck speed toward the bottom, with no stops, loops, or side trips along the way. With flow-control, programs can make decisions, inspect flags, and take actions based on previous operations, bit tests, logical comparisons, and arithmetic. Also, flow-control instructions give programs the ability to repeat instructions based on certain conditions, conserving memory by looping through the same sections of code over and over.

Table 4.5. 8086 Flow-Control Instructions.

<i>Mnemonic/Operands</i>	<i>Description</i>
Unconditional Transfer Instructions	
<code>call target</code>	Call procedure
<code>jmp target</code>	Jump unconditionally
<code>ret value</code>	Return from procedure

<i>Mnemonic/Operands</i>	<i>Description</i>
<code>retn value</code>	Return from near procedure
<code>retf value</code>	Return from far procedure
Conditional Transfer Instructions	
<code>ja/jnbe short-target</code>	Jump if above/not below or equal
<code>jae/jnb short-target</code>	Jump if above or equal/not below
<code>jb/jnae short-target</code>	Jump if below/not above or equal
<code>jbe/jna short-target</code>	Jump if below or equal/not above
<code>jc short-target</code>	Jump if carry
<code>je/jz short-target</code>	Jump if equal/0
<code>jg/jnle short-target</code>	Jump if greater/not less or equal
<code>jge/jnl short-target</code>	Jump if greater or equal/not less
<code>jl/jnge short-target</code>	Jump if less/not greater or equal
<code>jle/jng short-target</code>	Jump if less or equal/not greater
<code>jnc short-target</code>	Jump if no carry
<code>jne/jnz short-target</code>	Jump if not equal/0
<code>jno short-target</code>	Jump if no overflow
<code>jnp/jpo short-target</code>	Jump if NOT parity/parity odd
<code>jns short-target</code>	Jump if NOT sign
<code>jo short-target</code>	Jump if overflow
<code>jp/jpe short-target</code>	Jump if parity/parity even
<code>js short-target</code>	Jump if sign
Loop Instructions	
<code>jcxz short-target</code>	Jump if cx equals 0
<code>loop short-target</code>	Loop while cx <> 0
<code>loope/loopz short-target</code>	Loop while equal/0
<code>loopne/loopnz short-target</code>	Loop while not equal/not 0
Interrupt Control Instructions	
<code>int interrupt-type</code>	Interrupt
<code>into</code>	Interrupt on overflow
<code>iret</code>	Interrupt return

Although there may seem to be an overwhelming number of jump instructions in Table 4.5, the forest has only a few easily identified species to memorize. This chapter concentrates on the first two categories: conditional and unconditional jumps. Later chapters introduce loops and the interrupt control instructions.

Unconditional Transfers

An *unconditional transfer* changes the address of the next instruction to be executed. It operates like an exit-only ramp on a highway—once you’re in the lane, you’re going that-a-way, whether you want to or not. And once the processor executes an unconditional transfer, the destination instruction will be the next to execute without exception. Unconditional transfers load new address values into the *ip* register and, in some cases, into the *cs* code-segment register, too. Together, *cs:ip* specify the address of the next instruction to execute. Changing either or both registers changes the address of this instruction, altering the normal top-to-bottom program flow.

Calling Subroutines

One of assembly language’s most useful devices is the *subroutine*, a collection of related instructions, usually performing one repetitive operation. A subroutine might display a character string on-screen, add a series of values, or initialize an output port. Some subroutines live grandiose lives: making a chess move or logging on to a remote computer. Others play more humble roles: displaying a single character or reading a key press from the keyboard.

Some programmers write long subroutines that perform many jobs on the theory that multiple subroutines can make a fast program run slowly. Don’t do this. You may gain a tiny bit of speed by combining operations into a massive subroutine, but you are more likely to end up with a buggy and hard-to-maintain program over which you will ponder your original intentions while questioning the sanity of your decision to become a programmer.

The best subroutine does one and only one job. The best subroutine is as short as possible and only as long as necessary. The best subroutine can be listed on one or two pages of print-out paper. The best subroutine begins, not with code, but with comments describing the subroutine’s purpose, results, input expected, and registers affected. The best subroutine can be understood out of context by someone who has no idea what the entire program is doing. In other words, the best subroutine is short and sweet and neat.

Listing 4.7 demonstrates how to write a subroutine in assembly language. Assemble, link, and load into Turbo Debugger as you have the other examples in this chapter, using the commands:

```
tasm /zi subdemo
tlink /v subdemo
td subdemo
```

Listing 4.7. SUBDEMO.ASM.

```

1: %TITLE "Subroutine demonstration -- by Tom Swan"
2:
3:     IDEAL
4:
5:     MODEL    small
6:     STACK   256
7:
8:     DATASEG
9:
10:  exCode      DB      0
11:
12:     CODESEG
13:
14:  Start:
15:     mov     ax, @data      ; Initialize DS to address
16:     mov     ds, ax        ; of data segment
17:
18:     mov     al, 1         ; Load AL-DL with values
19:     mov     bl, 2         ; to add
20:     mov     cl, 3
21:     mov     dl, 4
22:     call    AddRegisters  ; AX <- AL+BL+CL+DL
23:     call    AddRegisters  ; again
24:     call    AddRegisters  ; and again!
25:
26:  Exit:
27:     mov     ah, 04Ch      ; DOS function: Exit program
28:     mov     al, [exCode]  ; Return exit code value
29:     int     21h          ; Call DOS. Terminate program
30:
31: ;-----
32: ; AddRegisters      Sum al, bl, cl, and dl
33: ;-----
34: ; Input:
35: ;     al, bl, cl, dl = Four 8-bit values to add
36: ; Output:
37: ;     ax = al + bl + cl + dl
38: ; Registers:
39: ;     ax, bh, ch, dh changed
40: ;-----
41:  PROC     AddRegisters
42:     xor     ah, ah        ; Set ah equal to zero
43:     xor     bh, bh        ; Set bh equal to zero
44:     xor     ch, ch        ; Set ch equal to zero
45:     xor     dh, dh        ; Set dh equal to zero
46:     add     ax, bx        ; AX <- AX + BX
47:     adc     ax, cx        ; AX <- AX + CX + CF
48:     adc     ax, dx        ; AX <- AX + DX + CF
49:     ret                    ; Return to caller
50:  ENDP    AddRegisters
51:
52:     END     Start        ; End of program / entry point

```

Running the SUBDEMO Program

The main portion of the SUBDEMO program is at lines 14-29. The subroutine is at lines 31-50. There are several new items in the code:

- The comments at lines 31-40 describe the subroutine's name, purpose, input, output, and affected registers. The dashed outlines are optional, serving mostly to mark the beginnings of many subroutines in a long listing. For many programmers, a personal subroutine header style is a valued trademark. If you want to use your own format, that's fine—just be sure to include at least the information shown here.
- The PROC and ENDP directives (lines 41, 50) mark the subroutine's beginning and ending.
- The ret instruction (line 49) must be included in every subroutine, but not necessarily on the last line as in this example.

The PROC and ENDP directives are optional, but I strongly suggest you use them to mark the beginnings and endings of all your subroutines. PROC and ENDP are directives to Turbo Assembler—they are not 8086 instructions. The PROC directive comes first, followed by the subroutine's name, which labels the address of the first instruction, here at line 42. The ENDP directive comes last, optionally followed by the same label name as in the preceding PROC. Including the name here shows which subroutine is ending, but you can leave the name blank if you prefer. In line 22, the main program *calls* the subroutine by using the call instruction along with the label AddRegisters. Two important actions take place when call executes:

- The *return address* of the next instruction following the call is pushed onto the stack.
- The address of the subroutine is inserted into register ip or, in some cases, into register pair cs:ip.

Before starting to run the called subroutine, the 8086 processor pushes the address of the instruction following the call onto the stack. This address is called the *return address* because it marks the location to which the subroutine should eventually return control. In this example, the first such return address is that of the instruction at line 23, another call. After pushing this address, the processor jumps unconditionally to the called label, executing the instruction at line 42. The program then continues running from that point, executing the instructions in the subroutine.

The reason for pushing the return address onto the stack becomes clear when the subroutine's ret instruction at line 49 executes. Like call, ret causes two important actions to occur:

- The return address is popped from the stack into register ip (or into cs:ip).
- The program continues running with the instruction following the call that previously activated the subroutine.

Figure 4.9 illustrates the action of the three call instructions in lines 22-24 of Listing 4.7.

Each `call` causes the subroutine's instructions to begin running until reaching the `ret` instruction, which returns control to the instruction immediately after the `call`. Different places in the program can call the same subroutine. To view this action on your computer, load Listing 4.7 into Turbo Debugger and follow these steps:

1. From the CPU window, press F8 six times, stopping just before you execute the `call` instruction at line 22. Notice that registers `a1`, `b1`, `c1`, and `d1` are loaded with values to pass to the subroutine for processing.
2. Instead of pressing F8 to execute the `call` instruction, press F7, the "trace into" key. You should see the instruction marker jump to the `xor` instruction at line 42, indicating that the subroutine code is ready to run. If you're quick, you might also see the return address pushed onto the stack (lower-right corner of the screen).
3. Press F7 repeatedly until you get to the `ret` instruction in line 49. Then press F7 again, executing `ret` and returning control to the instruction following the `call` in line 22.
4. Press F7 to again call the same subroutine. And then press F7 repeatedly as you did before, stopping after executing the `ret` instruction for a second time.
5. The instruction marker should now be poised on line 24, ready to execute the final `call`. This time, instead of F7, press F8—the key you normally use to single-step through programs. F8, the "step over" key, executes the subroutine at full speed, stopping only after the subroutine returns rather than showing you the individual instructions. Remember, to step *through* a subroutine, press F7 at the `call` instruction. To step *over* a subroutine, press F8. F8 is useful when you're positive that a subroutine is functioning correctly and you don't want to waste time single-stepping through the routine's instructions.

Figure 4.9.
Subroutine calls and returns.

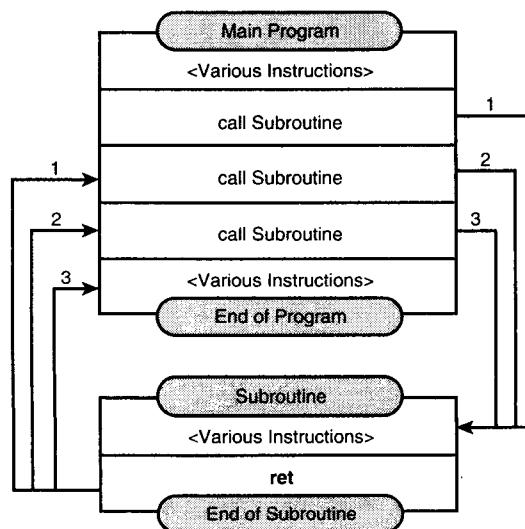

You should be able to understand how the `AddRegisters` subroutine works in Listing 4.7. Read the comments if you need help—there aren't any new instructions here. The `xor` instructions at lines 42–45 clear any extraneous values in the upper halves of the registers to be added. Then `add` and `adc` add the four values in `a1`, `b1`, `c1`, and `d1`, placing the sum in `ax`.

The Long and Short of It

Although Table 4.5 lists three return instructions—`ret`, `retf`, and `retn`—there actually are only two: `retf` and `retn`. The generic `ret` mnemonic allows Turbo Assembler to decide which of the other two returns is appropriate for the memory model in use. To understand the difference between `retf` and `retn`, you first have to understand the difference between an *intra*segment and *inter*segment subroutine call:

- An *intra*segment subroutine call activates a subroutine in the same code segment as the `call` instruction. In other words, upon transferring control to a new location, segment register `cs` remains unchanged; therefore, it's necessary to change only `ip` to run the subroutine. An *intra*segment return address is a 16-bit word.
- An *inter*segment subroutine call activates a subroutine in a different code segment from the segment containing the `call`. In this case, both `cs` and `ip` must be changed to the new location and the full 32-bit return address of the instruction following the call is pushed onto the stack.

There is only one `call` mnemonic because the assembler knows whether a called subroutine is near (in the same segment) or far (in a different segment) when it assembles the `call`. But there are two return mnemonics—`retn` for *near*, *intra*segment calls and `retf` for *far*, *inter*segment calls—to allow you to write near and far subroutines as you choose, changing the default instruction that Turbo Assembler generates for `ret`.

The best way to avoid confusion with these details is to let Turbo Assembler generate the correct codes for you. (After all, that's one reason for using an assembler in the first place.) To define a near subroutine, use the `NEAR` operator in the `PROC` definition:

```
PROC   SubName           NEAR
;----- insert subroutine instructions here
      ret
ENDP   SubName
```

To write an *inter*segment subroutine, change `NEAR` to `FAR`. Turbo Assembler will then assemble far calls to this subroutine and replace the `ret` instruction with `retf`.

NOTE

When using the small-memory model, as in most of this book's example programs, subroutines are assumed to be near (in the same code segment as calls to the subroutines). Consequently, specifying the `NEAR` operator in the `PROC` declaration is unnecessary.

Passing Values to and from Subroutines

From Listing 4.7, you can see that subroutine `AddRegisters` requires four 8-bit registers to hold values to add. The subroutine returns the sum of this addition in `ax`. Passing values in registers to subroutines is the most common method for giving subroutines data to process. Two other methods are:

- Storing data in global variables
- Passing data on the stack

Subroutines may operate directly on variables declared in the data segment, for example, the `exCode` byte at line 10. Usually, though, this is not a wise choice. Changing global variables from inside subroutines can lead to confusion over which subroutine changed which values when. In a complex program with hundreds or thousands of subroutines, many of which call each other in various sequences, two subroutines that affect the same global values may introduce a dangerous kind of bug called a *side effect* into your program. This problem develops when a program (or another subroutine) calls a subroutine that changes a global value currently used for other purposes.

Passing data on the stack is a good way to avoid side effects, especially when a subroutine requires many parameters. You could modify Listing 4.7 to follow this scheme. Before each call (lines 22–24), instead of loading registers `a1`, `b1`, `c1`, and `d1` with data to process, you might use these instructions:

```
mov ax, 1      ; First element
push ax       ; Push onto stack
mov ax, 2      ; Second element
push ax       ; Push onto stack
mov ax, 3      ; Third element
push ax       ; Push onto stack
mov ax, 4      ; Fourth element
push ax       ; Push onto stack
call AddValues
```

Notice that you must load a register (`ax` here) and then push that register onto the stack—you can't push literal values directly onto the stack. In the subroutine, you may think the first job is to pop the parameters from the stack. But this doesn't work:

```
PROC AddValues
  pop dx      ; ???
  pop cx
  pop bx
  pop ax
  :           ; Subroutine instructions
  ret
ENDP AddValues
```

The first `pop` accidentally removes the return address pushed by the `call` instruction, causing the subroutine to add the wrong values and to lose its ability to return to the calling place.

The solution is to remove the return address, pop the parameters, and then replace the return address back onto the stack. This takes another register:

```
PROC AddValues
    pop si      ; Save return address in si
    pop dx      ; Pop 4 parameters
    pop cx
    pop bx
    pop ax
    push si     ; Replace return address
    :          ; Subroutine instructions
    ret
ENDP AddValues
```

This works, but as you can see, passing values on the stack is not as easy as passing values directly in registers. It is possible to address parameters on the stack using a method employed in high-level languages, explained in Chapters 12 and 13. As you'll see, a special form of the `ret` instruction can remove the pushed parameters before popping the return address, eliminating some of the complexity of the method described here.

To Push or Not to Push

Listing 4.7's comment at line 39 tells you that `ax`, `bx`, `ch`, `sdh`, and various flags are changed by the subroutine. If the calling program uses any of these registers or flags for its own purposes, you now have a conflict to resolve. There are two solutions:

- Save the original register values before the `call`
- Save the original register values inside the subroutine

Ask six programmers, and you shall receive six opinions about which of these two methods for preserving registers is best. The first plan saves registers currently in use before calling subroutines that change those registers. In Listing 4.7, for example, if the calling program is using `bx` and `ch`, it might call the subroutine like this:

```
push bx          ; Save bx on the stack
push cx          ; Save cx, too
call AddRegisters ; Call subroutine
pop cx           ; Restore cx from the stack
pop bx           ; Restore bx, too
```

You must push the entire register (`ax`, `bx`, etc.), even if you need to preserve only the 8-bit halves (`ah`, `bl`, etc.). Pushing the registers onto the stack before the subroutine `call` saves the register values temporarily on the stack, from where the same register values are later restored after the subroutine finishes. Notice that the `pop` instructions must be in the reverse order from the `push` instructions.

The second school of thought on register preservation makes each subroutine responsible for saving and restoring the registers it changes—except, of course, for registers used to pass

values back to callers. With this approach, you could revise `AddRegisters` (lines 41–49) as follows:

```
PROC AddRegisters
    pushf      ; Save flags
    push bx   ; Save changed registers, too
    push cx
    push dx
    :         ; Subroutine instructions
    pop  dx   ; Restore registers
    pop  cx
    pop  bx
    popf      ; Also restore flags
    ret       ; Return to caller
ENDP AddRegisters
```

The calling program now can freely call the subroutine, which guarantees that, if it uses any registers for its own purposes, it will restore those registers to their original values before returning. This example also saves the flags with `pushf` and then restores the flags with `popf` just before the subroutine ends. This works because `call`, `push`, and `ret` (among others) do not change the flag values. Even so, saving and restoring flags this way is probably unnecessary, and few programs actually do this. If you need to save flag values, however, this is how to do it.

Which is the best method? Should the caller or the “callee” save registers affected by the subroutine? In practice, I usually make the subroutine responsible for saving the registers it changes—probably the preferred method of most assembly language programmers. This does entail some wasted effort, however, as the subroutine might needlessly save the value of a register that isn’t being used by the program that calls the subroutine. Even so, in a typical program with dozens of subroutines, many of which call each other in unpredictable sequences, it’s simply more practical, if not 100% efficient, to let the subroutines save and restore their modified registers. Sometimes, however, and especially where top speed is needed, I’ll ignore this rule of thumb and make the caller responsible for saving needed values. If you do this, be sure to carefully document which registers are changed inside the subroutine, or bugs are almost sure to surface later.

Jumping Unconditionally

The 8086 has well over a dozen different jump instructions (see Table 4.5). One of these, `jmp`, is an *unconditional jump*; the others are all *conditional jumps*. The difference between the two jump types is important:

- An unconditional jump always causes the program to start running at a new address.
- A conditional jump causes the program to start running at a new address only if certain conditions are satisfied. Otherwise, the program continues as though the conditional jump instruction did not exist.

The unconditional `jmp` works identically to `call`, except that the return address is not pushed onto the stack. The `jmp` instruction takes a single parameter: the label of the location where the program is to transfer control. For an example of how this works, modify Listing 4.7, inserting the following instruction between lines 21 and 22:

```
jmp Exit
```

When you single-step the modified program in Turbo Debugger, you'll see the `jmp` instruction skip the three `calls` in lines 22-24, jumping directly to the `mov` instruction at the `Exit` label. That's all `jmp` does. Use the instruction anytime you want to jump from somewhere to somewhere else. As with `call`, that somewhere else may be in the same code segment or in a different segment. Turbo Assembler implements the correct `jmp` for you, making either an intrasegment jump (to a different offset in the same code segment, changing only the `ip` register) or an intersegment jump (to a different segment and offset, changing both `cs` and `ip`). Most of the time, you'll use `jmp` to jump to locations in the same code segment—almost always the case with the small-memory model.

NOTE

Use `jmp` sparingly to avoid creating the well-known blue plate programmer's special, *spaghetti code*, where imaginary lines from numerous `jumps` to their target addresses entwine like pasta in a pot. You may as well play pickup sticks with wet noodles than figure out what such a program does.

Jumping Conditionally

Table 4.5 lists the 8086's 18 conditional jump instructions, many of which have two mnemonics representing the same instruction, for example, `je/jz` and `jg/jnl`, making a total of 30 mnemonics. This may seem to be an overwhelming number of conditional jumps to learn, but, like verb conjugations, the different forms are easy to remember if you separate the root (always *j* for jump) from the endings (*a*, *nbe*, *e*, *z*, etc.). Each of these endings represents a unique condition, as listed in Table 4.6. Once you memorize these meanings, you'll have little trouble differentiating among the many kinds of conditional jumps. In the table, the endings on the right are negations of the endings on the left. (Two conditional jump mnemonics, `jpe` and `jpo` do not have negative counterparts.)

All conditional jumps require a *target address*—a label marking the location where you want the program to continue running if the specified condition is met. For example, following a comparison of two registers with `cmp`, you might use `je` (jump if equal) to transfer control to a location if the values in the registers are equal. To demonstrate this, suppose you need a subroutine to return `cx` equal to 1 if `ax = bx` or to 0 if `ax <> bx`. This does the job:

```

PROC RegEqual
    mov cx, 1      ; Preset cx to 0001
    cmp ax, bx    ; Does ax equal bx?
    je Continue   ; Jump if ax = bx
    xor cx, cx    ; Else, set cx to 0000
Continue:
    ret           ; Return to caller
ENDP RegEqual

```

Table 4.6. Conditional Jump Endings.

<i>Ending</i>	<i>Meaning</i>	<i>Ending</i>	<i>Meaning</i>
a	above	na	not above
ae	above or equal	nae	not above or equal
b	below	nb	not below
be	below or equal	nbe	not below or equal
c	carry	nc	not carry
e	equal	ne	not equal
g	greater	ng	not greater
ge	greater or equal	nge	not greater or equal
l	less	nl	not less
le	less or equal	nle	not less or equal
o	overflow	no	not overflow
p	parity	np	not parity
pe	parity even	--	
po	parity odd	--	
s	sign	ns	not sign
z	zero	nz	not zero

First, `cx` is preset to 1, the result that indicates `ax` equals `bx`—a fact the subroutine doesn't know just yet. Next, a `cmp` compares `ax` and `bx`. Remember that `cmp` performs a subtraction (`ax - bx`) but throws away the result, setting the zero flag `zf` to 1 if the result is zero, or to 0 if the result is not zero. The `je` conditional jump tests the zero flag, transferring control to the `Continue` label if the condition is met—namely that `zf = 1`, indicating that `ax` equals `bx` and, therefore, preserving the preset value in `cx`. If the condition is not met (`zf = 0`), then the `xor` instruction sets `cx` to 0. In either case, the `ret` instruction executes last, returning control to the location after the `call` instruction that activated the subroutine.

A downward jump as in this example—skipping an assignment to a register or, perhaps, a call to another subroutine—is probably the most typical use for conditional jumps. But you can also jump up to create loops in programs. For example, this fragment increments `ax` by 1, calling a subroutine `Print` (not shown here) until `ax` equals 10:

```

    xor ax, ax      ; Preset ax to 0000
Count:
    inc ax         ; ax <- ax + 1
    call Print     ; Call subroutine
    cmp ax, 10    ; Is ax = 10?
    jne Count     ; Jump if ax <> 10
    :             ; Program continues here

```

The loop extending from `Count:` to `jne` executes repeatedly as long as `ax` is not equal (*ne*) to 10. As in the previous example, the `cmp` instruction sets the flags for the following conditional jump to test. If the condition is not met—in other words, if `ax` does not yet equal 10—control transfers back up to `Count`, starting the loop over from the `inc` instruction. When `ax` hits 10, the condition fails, and `jne` does not transfer control to the target label, continuing instead with the next instruction below.

Double Jumping

As you can see from Table 4.5, many conditional jumps have two names for the same instruction. In all cases, you can use either mnemonic interchangeably. For example `je` and `jz` assemble to the identical machine code.

Why, then, do you need the two different names? The answer is: Simply to make programming easier. Literally translated, `jz` means “jump if the zero flag equals 1” while `je` translates to “jump if equal.” The reason for the two different translations is more obvious when you consider how this jump instruction is used. After a `cmp` operation, if the result is 0, then the zero flag is set to 1. Knowing this, you could use `jz` to test the zero flag and jump to another location.

To avoid forcing you to perform similar mental gymnastics at every step in a program, the 8086 instructions set provides alternate mnemonics that make more sense in given situations. After a `cmp`, you simply use `je` to test if the operands were equal. Or you can use `jne` to test if the operands were not equal. In most cases, you don't even have to be aware of which flags are set and tested.

NOTE

Sometimes, of course, you'll want to know which flags are being tested by a conditional jump. At these times, look up the instruction's mnemonic in Chapter 16. Also listed in this chapter are the exact combinations of flag bits inspected by each conditional jump instruction.

Using Conditional Jumps

Learning which conditional jump to use in a given situation takes practice. Reading assembly language programs will help, and, as you read through this book, you'll see most of the conditional jumps in action. Be sure to memorize the endings in Table 4.6. Also, understand the difference between the two phrases, *above-below* and *less-greater*, as used in instructions such as `jb` and `jge`. Remember these two points:

- use above-below jumps such as `ja` and `jbe` with *unsigned* values
- use less-greater jumps such as `jle` and `jg` with *signed* values

Because of the wrap-around effect in arithmetic operations on binary values expressed within fixed numbers of bits, the difference between comparisons of signed and unsigned values is important. (Adding 1 to hexadecimal `FFFF`, for example, equals `0000` within 16 bits. In decimal, this is equivalent to the strange but true equation, $65,535 + 1 = 0$.) A few examples help clarify this important detail. Suppose you subtract two registers and want to jump to a certain location if the result is less than 0. This is the correct way to accomplish your goal:

```
sub ax, bx      ; ax ← ax - bx
jl  Negative   ; Jump if ax < bx
```

If the subtraction of `bx` from `ax` results in a negative value, then the condition of `j1` succeeds, and control transfers to the address of the `Negative` label. Obviously, if `ax` is less than `bx`, then the result of subtracting `bx` from `ax` will be negative. Replacing `j1` with `jb`, through, does not work:

```
sub ax, bx      ; ax ← ax - bx
jb  Negative   ; ???
```

The above-below conditional jumps test the results of comparisons and other operations on unsigned (positive) whole numbers. Even if `bx` is greater than `ax`, the result of subtracting unsigned `bx` from `ax` is still an unsigned value. To test whether the unsigned `ax` is greater than unsigned `bx`, you can write:

```
cmp ax, bx      ; Is unsigned ax > bx?
ja  Greater     ; Jump if ax > bx
```

The `ja` (jump if above) instruction correctly tests the result of a comparison between two unsigned values. Only if `ax` is greater than `bx` does the jump occur. If `ax` is below or equal to `bx`, then the jump does not occur. On the other hand, if `ax` and `bx` were signed values, then `ja` would not be appropriate here—instead, you'd probably want to use the signed conditional jump, `jg`.

NOTE

Get into the habit of using “above-below” for unsigned comparisons and “greater-less” for signed comparisons. Do this in your programs, in your speech, and in your notes and comments. There’s no easy trick to learning the differences—you just have to memorize the rules.

Conditional Restrictions

All conditional jumps have one major restriction: They can transfer control only a very short distance away—exactly 128 bytes back (to a lower address) or 127 bytes forward (to a higher address) from the first byte of the instruction immediately *following* the jump. Counting the 2 bytes that each conditional jump occupies, you can jump a tiny bit farther ahead than back—a small detail that rarely matters very much. Don’t worry. Turbo Assembler will tell you if you try to jump too far.

The conditional jump target in the range of -128 to 127 bytes is called the *displacement*, a value calculated for you by the assembler from the label you supply in your program’s text. The displacement—not the actual address of the target label—is inserted into the assembled machine code for this jump instruction. You never have to calculate the displacement manually, but you should be aware that because the target address is expressed as a displacement, conditional jumps have the marvelous property of executing identically at any memory location without change, leading to an interesting fact about 8086 programming:

NOTE

Code that uses only conditional jumps can execute anywhere in memory. Such code is relocatable—able to be relocated in memory and then executed without change.

Although relocatable conditional jumps are usually advantageous, when you absolutely must jump conditionally to a far-away location, the limited displacement range can be troublesome. To jump farther than about 127 bytes away requires a combination of conditional and unconditional jumps. For example, suppose you want the program to jump to an `Error` routine if `dx` equals 1, perhaps halting the program with a message. You could write:

```

    cmp dx, 1           ; Is dx = 1?
    jne Continue       ; Jump if dx <> 1
    jmp Error          ; Error, halt (dx = 1)
Continue:
    :                  ; No error, continue program

```

If `dx` equals 1, then the `jne` conditional fails, executing the unconditional `jmp`, which transfers control to `Error`, presumably out of range of `jne`. When combining jumps this way, carefully think through the logic—it's easy to pick the wrong conditional, a common source of bugs. To avoid confusion, remember this hint:

TIP

Use the opposite conditional jump than you normally would use if the target is within range. Then follow with an unconditional `jmp` to that target.

You can see how this hint works by examining the code for the previous example if the `Error` label is in range of the conditional jump. The much simpler program now becomes:

```
cmp dx, 1      ; Is dx = 1?
je  Error     ; Error, halt (dx = 1)
```

Obviously, this fragment jumps to `Error` if `dx` equals 1. To jump conditionally to an out-of-range label requires the opposite conditional (`jne` instead of `je`) followed by the unconditional `jmp` to the target.

Learning More About Conditional Jumps

To learn more about how each conditional jump instruction operates, try running some of the previous examples in Turbo Debugger. You should be able to do this on your own by now. Just take one of the test programs you entered earlier and replace the guts with the programming from this text—or, even better, make up your own examples. (You'll have to supply labels for any subroutine calls and jumps.)

Chapter 16 lists each conditional jump in detail. Refer to this chapter to learn which flag bits are affected by each instruction. Above all, think logically. After a comparison, question your motives. Do you want to jump if the result is less or greater (signed), or if the result is above or below (unsigned)? Keep your jumps to the minimum distances possible and avoid using too many jumps. A typical mistake is to write code like this:

```
    cmp bx, 5          ; Is bx = 5?
    jne Not5          ; No, jump to Not5
    mov ax, [count5]  ; Yes, Load ax with [count5]
    jmp Continue      ; Jump to skip next instruction
Not5:
    mov ax, [count]   ; Load ax with [count]
Continue:
    :                 ; Program continues here
```

This fragment requires two labels and two jump instructions just to load `ax` with a different value depending on whether `bx` equals 5. Try not to hop around so much. Preloading `ax` with one of the two possible results eliminates a label and the unconditional jump:

```

mov ax, [count 5] ; Preset ax <- [count5]
cmp bx, 5         ; Is bx = 5?
je Continue      ; Yes, ax is correct, so jump
mov ax, [count]  ; No, load ax with other value
Continue:
; Program continues here

```

Not only is this shorter and easier to read, the code operates more quickly when `bx` does not equal 5. (A `jmp` instruction as used here takes more processor time to execute than a `mov` between a register and memory location; therefore, the two `movs` are not as wasteful as you may think on a casual reading.)

Processor Control Instructions

The set of 8086 instructions listed in Table 4.7 directly operate on the processor. In all cases but one, these processor control instructions assemble to single-byte codes and require no operands. Most of the instructions set or clear individual flag bits. Others synchronize the processor with external events and, in one case, `nop` actually does nothing at all.

Table 4.7. 8086 Processor Control Instructions.

<i>Mnemonic/Operands</i>	<i>Description</i>
Flag Instructions	
<code>cld</code>	Clear carry
<code>cld</code>	Clear direction (auto-increment)
<code>cli</code>	Clear interrupt-enable flag
<code>cmc</code>	Complement carry
<code>stc</code>	Set carry
<code>std</code>	Set direction (auto-decrement)
<code>sti</code>	Set interrupt-enable flag
External Synchronization Instructions	
<code>esc immediate, source</code>	Escape to coprocessor
<code>hlt</code>	Halt processor
<code>lock</code>	Lock the bus
<code>wait</code>	Wait for coprocessor
Miscellaneous	
<code>nop</code>	No operation

This fragment requires two labels and two jump instructions just to load `ax` with a different value depending on whether `bx` equals 5. Try not to hop around so much. Preloading `ax` with one of the two possible results eliminates a label and the unconditional jump:

```

mov ax, [count 5]    ; Preset ax <- [count5]
cmp bx, 5            ; Is bx = 5?
je Continue         ; Yes, ax is correct, so jump
mov ax, [count]     ; No, load ax with other value
Continue:
; Program continues here

```

Not only is this shorter and easier to read, the code operates more quickly when `bx` does not equal 5. (A `jmp` instruction as used here takes more processor time to execute than a `mov` between a register and memory location; therefore, the two `movs` are not as wasteful as you may think on a casual reading.)

Processor Control Instructions

The set of 8086 instructions listed in Table 4.7 directly operate on the processor. In all cases but one, these processor control instructions assemble to single-byte codes and require no operands. Most of the instructions set or clear individual flag bits. Others synchronize the processor with external events and, in one case, `nop` actually does nothing at all.

Table 4.7. 8086 Processor Control Instructions.

<i>Mnemonic/Operands</i>	<i>Description</i>
Flag Instructions	
<code>clic</code>	Clear carry
<code>cld</code>	Clear direction (auto-increment)
<code>cli</code>	Clear interrupt-enable flag
<code>cmc</code>	Complement carry
<code>stc</code>	Set carry
<code>std</code>	Set direction (auto-decrement)
<code>sti</code>	Set interrupt-enable flag
External Synchronization Instructions	
<code>esc immediate, source</code>	Escape to coprocessor
<code>hlt</code>	Halt processor
<code>lock</code>	Lock the bus
<code>wait</code>	Wait for coprocessor
Miscellaneous	
<code>nop</code>	No operation

This fragment requires two labels and two jump instructions just to load `ax` with a different value depending on whether `bx` equals 5. Try not to hop around so much. Preloading `ax` with one of the two possible results eliminates a label and the unconditional jump:

```

mov ax, [count 5] ; Preset ax <- [count5]
cmp bx, 5         ; Is bx = 5?
je Continue      ; Yes, ax is correct, so jump
mov ax, [count]  ; No, load ax with other value
Continue:
                ; Program continues here

```

Not only is this shorter and easier to read, the code operates more quickly when `bx` does not equal 5. (A `jmp` instruction as used here takes more processor time to execute than a `mov` between a register and memory location; therefore, the two `movs` are not as wasteful as you may think on a casual reading.)

Processor Control Instructions

The set of 8086 instructions listed in Table 4.7 directly operate on the processor. In all cases but one, these processor control instructions assemble to single-byte codes and require no operands. Most of the instructions set or clear individual flag bits. Others synchronize the processor with external events and, in one case, `nop` actually does nothing at all.

Table 4.7. 8086 Processor Control Instructions.

<i>Mnemonic/Operands</i>	<i>Description</i>
Flag Instructions	
<code>clc</code>	Clear carry
<code>cld</code>	Clear direction (auto-increment)
<code>cli</code>	Clear interrupt-enable flag
<code>cmc</code>	Complement carry
<code>stc</code>	Set carry
<code>std</code>	Set direction (auto-decrement)
<code>sti</code>	Set interrupt-enable flag
External Synchronization Instructions	
<code>esc immediate, source</code>	Escape to coprocessor
<code>hlt</code>	Halt processor
<code>lock</code>	Lock the bus
<code>wait</code>	Wait for coprocessor
Miscellaneous	
<code>nop</code>	No operation

Flag Operations

The first group of instructions in Table 4.7 sets and clears individual flag bits. A flag is set when it equals 1. It's clear when it equals 0. You can set and clear the carry flag (`stc` and `c1c`), the direction flag (`std` and `c1d`), and the interrupt flag (`sti` and `c1i`). You can also complement the carry flag with `cmc`, toggling `cf` from 1 to 0 or from 0 to 1.

The direction flag instructions are used exclusively with the string instructions in Table 4.8. Chapter 5 explains how to use these instructions. The interrupt flag bit is normally set or cleared inside interrupt service routines, as Chapter 10 explains. In general, `sti` allows most kinds of interrupts to occur, while `c1i` prevents their occurrence.

One typical use for `stc` and `c1c` is to set the carry flag to pass back a result from a subroutine. For example, you could write a routine to test whether a certain bit is set in a value passed in register `d1`:

```
PROC TestBit
    test dl, 08h        ; Test bit 3
    jz  Exit           ; Exit if bit 3 = 0
    stc                ; Set carry flag
Exit:
    ret                ; Return to caller
ENDP TestBit
```

This procedure tests whether bit 3 equals 1, setting the carry flag to 1 only if it does. The `test` instruction resets the carry flag regardless of the operand values, but it also sets the zero flag to 1 only if the result is 0—indicating in this example that bit 3 in `d1` is 0. In that event, the `jz` instruction jumps directly to `Exit`, leaving `cf = 0`. Otherwise, the `stc` instruction sets the carry flag, returning `cf = 1`. The main program might call the subroutine this way:

```
mov  d1, [testvalue]  ; Load test value into d1
call TestBit          ; Call test subroutine
jc  BitIsSet          ; Jump if bit 3 = 1
:                    ; Program continues if bit 3 = 0
```

After calling `TestBit`, the `jc` instruction transfers control to `BitIsSet` only if `cf = 1`. Passing the carry flag back from a subroutine this way is common in assembly language programming. Also, you'll often see routines that use `cf` to indicate whether an error occurred. For example, to call a hypothetical routine `DiskRead` and check for an error, you might write something like this to jump to your error handler if the subroutine fails:

```
    call DiskRead      ; Read the disk (subroutine not shown)
    jnc Continue      ; Continue program if no error (CF = 0)
    jmp Error         ; Else, jump to error handler (CF = 1)
Continue:
:                    ; Program continues here
```

Getting in Synch

The 8086 external synchronization instructions are rare birds for which you'll probably have only occasional uses. `hlt` brings the processor to a screeching halt, continuing only after receiving one of two kinds of interrupts. (See Chapter 10 for more information about interrupts.) The most typical use for `hlt` is to force the processor to wait for a signal from an external device, continuing only when the device gives the processor the green light to proceed.

`wait` and `esc` are used to interface the 8086 with a math coprocessor. `Esc` is the only processor control instruction that requires operands.

`lock` causes the 8086 to assert (turn on) a signal that interface circuits can recognize as a notice that the *bus* is in use. (The bus is the collection of lines to and from the processor, memory and elsewhere, over which data bits travel their various routes.) `lock` is not really a separate instruction, but a prefix for another instruction, most often `xchg`. In a computer with multiple processors accessing the same memory locations, you can use `lock` to avoid the potential conflict of both processors writing to the same location simultaneously. If you need this capability, refer to Intel's documentation (see Bibliography). In most PC programming, `lock` isn't needed.

Something for Nothing

`Nop` is perhaps the strangest of all 8086 instructions. From the instruction's name, you may think that `nop` doesn't do anything. And so it doesn't! Executing `nop` is like accelerating a car in neutral—push the pedal to the floorboards and you're still going nowhere fast. But in the sometimes wacky world of assembly language programming, even nothing has its purposes. `Nop` comes in handy usually in two ways:

- To remove another instruction temporarily
- To save space for a forward `jmp`

`Nop` is most useful when you want to remove an instruction from a program without having to reassemble and link. Poking a few `nop` machine codes (hexadecimal 90) over other instructions is a useful debugging trick. When trying to locate the source of a bug, try replacing a suspect instruction or two with `nops` in the hope that this will reveal hidden mistakes. Often, removing instructions is good way to learn what effects those instructions have. For example, suppose you want to examine what happens in Listing 4.7 (SUBDEMO) if line 42 does not zero `ah`. You could remove the instruction in the text, reassemble, link, and test. Or you can just load the already assembled code into Turbo Debugger and follow these steps:

1. Open the CPU window and move the selector bar to the `xor` instruction at the beginning of `AddRegisters`. Note the address to the left, probably something like `cs:001D`.

2. Press Tab to move the cursor to the memory dump area in the CPU window's bottom-left corner.
3. Press Ctrl-G to select the Goto command. Then enter the address from step 1, for example, cs:001Dh. (Remember to add the *h* for hexadecimal!)
4. The cursor should now be positioned on the first of two bytes, 32 and E4, the binary machine codes for the `xor ah, ah` instruction. Verify this by comparing the bytes in the memory dump area with the disassembled code above.
5. Change the byte values by typing `090h 090h` and watch the disassembled code above when you press Enter. The 2-byte `xor` instruction instantly changes to two single-byte `nops`.
6. Use F7 to step through the modified program, observing what happens (or, rather, doesn't happen) to `ah` when the `nops` execute. When the subroutine ends (at the `ret` instruction), `ax` no longer correctly holds the sum of the four registers. As this test proves, zeroing `ah` is necessary to ensure an accurate result.
7. To reset the program, press Ctrl-F2 or replace the `nops` with their original machine codes, `032h` and `0E4h`.

Saving Jump Space

Turbo Assembler will occasionally insert a `nop` to reserve space for a `jmp` instruction. Earlier, you learned that `jmp` transfers control unconditionally to a target address. But, depending on how far away you are jumping, Turbo Assembler generates one of several machine code forms for `jmp`, adding from 2 to 5 bytes to the assembled program. Normally, you can ignore this fact and just let the assembler choose the most efficient form, which it will always do. Even so, because Turbo Assembler is a one-pass assembler—reading your source code only one time to generate object code—a problem develops with instruction sequences such as:

```

    or  ax, bx      ; Does ax = bx?
    jz  Skip       ; Jump if yes
    jmp Elsewhere  ; Else jump to Elsewhere
Skip:
    mov ax, 1      ; Set ax to 1 if ax = bx
    jmp Continue  ; Skip next command
Elsewhere:
    mov ax, 2      ; Set ax to 2 if ax <> bx
Continue:
    :              ; Program continues

```

Although this sequence has no practical purpose, it demonstrates a typical problem. When Turbo Assembler reaches the first `jmp` instruction—which in this case jumps forward to a higher memory location—the assembler doesn't yet know how far it is from the `jmp` to the target address at `Elsewhere`. Always the pessimist, Turbo Assembler assumes the worst—that `Elsewhere` will be greater than 127 bytes ahead. Therefore, the assembler reserves space for a 3-byte `jmp`, which has a reach of about +/-32K. Upon reaching `Elsewhere`, Turbo Assembler

realizes its error—Elsewhere is close enough for the shorter 2-byte `jmp` to reach, within 128 bytes back or 127 bytes forward. Because the 2-byte `jmp` operates more quickly than the 3-byte version, Turbo Assembler goes back and changes the `jmp` to the 2-byte model. To avoid having to reassemble the other instructions between this `jmp` and Elsewhere, the assembler changes the now extra third byte to a `nop`, then continues on with the rest of the program. If you assemble this short example, you'll see code that looks something like this:

```
cs:0000 EB 04      jmp Elsewhere
cs:0002 90          nop
```

The inserted `nop` does nothing but occupy space. Because of the preceding unconditional `jmp`, the `nop` never even executes. To get rid of the do-nothing `nop`, saving 1 byte, place a `SHORT` directive before the `jmp` target address:

```
jmp SHORT Elsewhere
```

This forces Turbo Assembler to use the 2-byte `jmp` version. Of course, if Elsewhere later turns out to be farther than 127 bytes away, you'll receive an error and will have to remove the `SHORT` directive.

Using the JUMPS Directive

If you insert a `JUMPS` directive on a line somewhere early in your program, Turbo Assembler allows you to use conditional jump instructions to locations that are farther away than the normal restriction of about 127 bytes. There's a catch with this directive, however. Suppose you write:

```
JUMPS
or ax, ax      ; Is ax = 0?
je There      ; Jump if ax = 0
mov ax, 5     ; Else set ax to 5
There:
```

With the `JUMPS` directive in effect, when Turbo Assembler assembles the `je` instruction, it actually inserts:

```
je There
nop
nop
nop
There:
```

The three `nops` reserve space for alternate code that the assembler inserts if the target label `There` is farther away than `je` can normally reach:

```
jne Temp
jmp There
Temp:
```

Instead of assembling the `je` that you wrote, Turbo Assembler inserts the opposite instruction `jne` followed by an unconditional `jmp`—exactly the same as explained earlier. The `Temp` label is just for illustration—a label isn't actually inserted into the program. The problem with `JUMPS` is those extra `nops`, which are inserted whether or not they are needed. For this reason, I prefer to write double jumps explicitly. The `JUMPS` directive does come in handy as a temporary tool, though. After finishing a program design, you can convert the long jumps to explicit double jump instructions and remove the `JUMPS` directive from the final assembly. This will eliminate the wasteful `nops`.

String Instructions

The 8086 string instructions in Table 4.8 are powerful little engines for processing all kinds of data—not just character strings. Remember that strings in assembly language are sequences of bytes that may or may not represent ASCII characters. Despite their suggestive names, the 8086 string instructions don't care what the bytes mean. String instructions divide into three groups:

- String transfer instructions
- String inspection instructions
- Repeat prefix instructions

Table 4.8. 8086 String Instructions.

<i>Mnemonic/Operands</i>	<i>Description</i>
String Transfer Instructions	
<code>lods source</code>	Load string bytes or words
<code>lodsb</code>	Load string bytes
<code>lodsw</code>	Load string words
<code>movs destination, source</code>	Move string bytes or words
<code>movsb</code>	Move string bytes
<code>movsw</code>	Move string words
<code>stos destination</code>	Store string bytes or words
<code>stosb</code>	Store string bytes
<code>stosw</code>	Store string words
String Inspection Instructions	
<code>cmps destination, source</code>	Compare string bytes or words
<code>cmpsb</code>	Compare string bytes

continues

Table 4.8. continued

<i>Mnemonic/Operands</i>	<i>Description</i>
<i>String Inspection Instructions</i>	
cmpsw	Compare string words
scas <i>destination</i>	Scan string bytes or words
scasb	Scan string bytes
scasw	Scan string words
<i>Repeat Prefix Instructions</i>	
rep	Repeat
repe/repz	Repeat while equal/0
repne/repnz	Repeat while not equal/0

String transfer instructions move bytes and words from memory to a register, from a register to memory, or directly from memory to memory. *String inspection instructions* let you compare and scan bytes and words, searching for specific values. *Repeat prefix instructions* can be attached as prefaces to other string instructions, creating single commands that repeat a number of times or cycle until a specified condition is met. A prefixed string instruction can quickly fill thousands of bytes with values, copy strings from one location to another, and search large memory blocks for values.

Despite the many mnemonics in Table 4.8, there are actually only five string instructions: `lodsb`, `stos`, `movsb`, `scas`, and `cmpsb`. The others are shorthand mnemonics for these same commands. As you can see in the table, the shorthand names such as `lodsb` and `cmpsw` require no operands and, therefore, are easier to use. Similarly, there are only two repeat prefixes: `rep` is identical to `repe` and `repz`. And `repne` and `repnz` represent the same prefix. The interchangeable names are provided merely to help you document exactly what your program is doing.

String Index Registers

All string instructions use specific registers to perform their duties. Unlike other instructions that let you decide which registers to use, string instructions are finicky, always operating with the same combination of registers `ds:si` and `es:di`—the source and destination string index registers, which specify offsets in the data and extra segments.

NOTE

If `ds` and `es` address the same data segment, as they often do, then you don't have to be concerned about addressing the correct memory segments during string operations. When `ds` and `es` address different segments, you must be careful to reference the correct segment for the operations you want to perform. Also, the destination index `di` is always relative to the segment addressed by `es`. The source index `si` is normally relative to the segment addressed by `ds` unless you override this by using `es` explicitly as in `es:si`.

The five string instructions load, store, move, compare, and scan bytes and words. While performing these jobs, each string instruction also increases or decreases the registers they use. Byte operations subtract or add 1 to `si` or `di` (or both); word operations add or subtract 2. For example, if `si` equals 0010 hexadecimal, then after a `lodsw` operation, `si` would be advanced to 0012 (or retarded to 000E, depending on the direction of the string operation). Because of this effect on the index registers, by adding a repeat prefix to a string instruction, programs can process whole sequences of data with a single command.

The direction flag `df` specifies whether string instructions should increase or decrease `si` and `di`. If `df = 1`, then the indexes are decreased toward lower addresses. If `df = 0`, then the indexes are increased toward higher addresses. Use `cld` to clear `df`, automatically incrementing `si` and `di` toward higher addresses. Use `std` to set `df`, automatically decreasing `si` and `di` toward lower addresses.

NOTE

Although you can set or clear `df` at the beginning of a program, because `df` could be changed by another routine, the safest course is always to set or clear the direction flag immediately before every string operation. This wastes very little time and is good preventive medicine against bugs.

Loading Strings

The `lods` instruction loads data addressed by `ds:si` or `es:si` into `al` for byte operations or onto `ax` for word operations. After this, `si` is increased or decreased, depending on the setting of the direction flag `df`. Byte operations adjust `si` by 1; word operations, by 2. With this instruction, you can construct a simple loop to search for a byte value:

```

    cld                ; Auto-increment si
Repeat:
    lods [byte ptr ds:si] ; al <- [ds:si]; si <- si + 1
    or  al, al          ; Is al = 0?
    jne Repeat         ; Repeat if al <> 0

```

First, `cld` clears `df`, preparing to auto-increment `si` after each `lods`, which copies into `al` the byte addressed by `ds:si`. Then `si` is advanced to address the next byte in memory. After loading each byte, an `or` instruction tests if `al` equals 0. If not, the `jne` jumps back to label `Repeat:`, thus repeating this sequence until finding a zero byte. (If no zero byte exists in the segment at `ds`, by the way, this loop will repeat “forever.” Take care that you don’t introduce a bug into your programs with loops such as this.)

NOTE

Auto-incrementing or decrementing `si` and `di` past the edge of a segment causes the registers to “wrap around” to the other segment end. In other words, if `si` or `di` are equal to `0FFFFh`, adding 1 “advances” the registers to `0000`. Likewise, if the registers equal `0000`, subtracting 1 “retards” the registers to `0FFFFh`.

Using Shorthand String Mnemonics

Because `lods` normally operates on the value addressed by `ds:si`, Turbo Assembler gives you two shorthand mnemonics that do not require operands, `lods b` and `lods w`. The *sb* in this and other shorthand string mnemonics stands for *string byte*. The *sw* stands for *string word*. Table 4.9 lists the equivalent longhand forms for all the shorthand mnemonics.

Table 4.9. String Instruction Shorthand.

<i>Shorthand</i>	<i>Equivalent String Instruction</i>
<code>lods b</code>	<code>lods [byte ptr ds:si]</code>
<code>lods w</code>	<code>lods [word ptr ds:si]</code>
<code>stos b</code>	<code>stos [byte ptr es:di]</code>
<code>stos w</code>	<code>stos [word ptr es:di]</code>
<code>movsb</code>	<code>movs [byte ptr es:di], [byte ptr ds:si]</code>
<code>movsw</code>	<code>movs [word ptr es:di], [word ptr ds:si]</code>
<code>scas b</code>	<code>scas [byte ptr es:di]</code>
<code>scas w</code>	<code>scas [word ptr es:di]</code>
<code>cmpsb</code>	<code>cmps [byte ptr ds:si], [byte ptr es:di]</code>
<code>cmpsw</code>	<code>cmps [word ptr ds:si], [word ptr es:di]</code>

Addressing String Labels

Turbo Assembler allows you to specify data labels in the long forms of the string instructions in Table 4.9. For example, to load into `al` the first byte of a string `s1`, you can write:

```

DATASEG
string db 'This is a string', 0

CODESEG
mov si, offset string      ; Assign address of string to si
lods [string]              ; Get first byte of string

```

But the instruction `lods [string]` does not assemble as you may think. Instead, Turbo Assembler converts this instruction to `lodsb`, assuming that you previously loaded the offset address of `string` into `si`. Remember that all string instructions require specific registers to address the data on which the instructions operate. Even when you specify a variable by name as in this example, you still have to load `si` or `di` with the appropriate addresses for the instruction. Specifying a variable by name merely lets Turbo Assembler verify that this variable is probably addressable by the appropriate registers. The assembler doesn't initialize the index registers for you.

Storing Data to Strings

`stos` and the shorthand mnemonics `stosb` and `stosw` store a byte in `al` or a word in `ax` to the location addressed by `es:di`. As with `lods`, `stos` increments or decrements `di` by 1 or 2, depending on the setting of `df` and whether the data is composed of bytes or words. Combining `lods` and `stos` in a loop can transfer strings from one location to another:

```

    cld                ; Auto-increment si and di
Repeat:
    lodsw              ; ax <- [ds:si]; si <- si + 2
    cmp ax, 0FFFFh    ; Is ax = 0FFFFh?
    je  Exit          ; Jump if ax = 0FFFFh
    stosw              ; [es:di] <- ax; di <- di + 2
    jmp Repeat        ; Repeat until done
Exit:

```

In this example, first the `cld` instruction prepares to auto-increment `si` and `di`. Then, `lodsw` loads into `ax` the word addressed `ds:si`, also incrementing `si` by two. If `ax` equals the value `0FFFFh`—presumably placed into memory by another routine as an end-of-data marker—the `je` instruction exits the loop. Otherwise, `stosw` stores the word in `ax` to the location addressed by `es:di`, also incrementing `di` by 2. The final `jmp` repeats these actions until detecting the `0FFFFh` marker. Once again, the danger here is that `0FFFFh` does not exist in the data segment. As you'll learn later, there are other ways to code this operation that eliminate this problem.

Moving Strings

Use `movs` or the shorthand forms `movsb` and `movsw` to move bytes and words between two memory locations. Because these instructions do not require an intermediate register to hold data on its way from and to memory, they are the fastest tools available by moving data blocks. As with other string instructions, you can use the longhand form along with operands, or, as most programmers prefer, you can use the simpler shorthand mnemonics.

`movsb` moves 1 byte from the location addressed by `ds:si` or `es:si` to the location addressed by `es:di`, incrementing or decrementing both index registers by 1. `movsw` moves a word between the two locations, incrementing or decrementing the registers by 2. Although you can use these instructions alone to transfer one byte or word—or construct a loop to transfer many successive values—you'll most often add a repeat prefix as in this sample:

```
cld                ; Auto-increment si, di
mov cx, 100        ; Assign count to cx
rep movsb          ; Move 100 bytes
```

These three little instructions move 100 bytes of memory starting at `ds:si` to the location starting at `es:di`. The repeat prefix `rep` repeatedly executes `movsb`, subtracting 1 from `cx` after each repetition, and ending when `cx` equals 0. You must use `cx` for this purpose. Without a repeat prefix, you'd have to write the instructions this way:

```
    cld                ; Auto-increment si, di
    mov cx, 100        ; Assign count to cx
Repeat:
    movsb              ; [es:di] <- [ds:si]; advance si & di
    dec cx              ; Count number of Loops done
    jnz Repeat        ; Repeat Loop if cx <> 0
```

But, with a repeat prefix, there's no need to go to all this trouble; furthermore, handling the counting chores yourself results in slower code.

NOTE

Strange-but-True Department: Some perfectly valid repeated string instructions produce senseless code. For example, you can write `rep lodsb`, loading `cx` successive bytes into `al`. Because each new value erases the previous value in `al`, there's never a good reason to perform such a wasteful instruction.

Filling Memory

The `stos` instruction makes filling memory with a byte or word value easy. Be careful with this one. It can erase an entire memory segment in a flash. For example, this stores bytes equal to 0 in a 512-byte block of memory, starting at the label `Buffer`:

```

mov ax, SEG Buffer      ; Assign segment address of Buffer
mov es, ax              ; to extra segment register es
mov di, OFFSET Buffer   ; Assign offset address to di
xor al, al              ; Assign value to store in memory
mov cx, 512             ; Assign count to cx
cld                     ; Prepare to auto-increment di
rep stosb               ; Set 512 bytes to zeros

```

First `es` is assigned the segment address of the variable to be erased to all zeros. The `SEG` operator returns the segment portion of a variable, here `Buffer`. This value is first assigned to `ax`, which is then assigned to `es`. (The two steps are necessary because of the restriction against moving literal values directly into segment registers such as `es`.) After this, `di` is initialized to address the beginning of `Buffer`, `al` is set to the value to store in memory, and the number of bytes is loaded into `cx`. Finally, after `cld` sets `df` to 1, preparing to auto-increment `di`, the repeated `stosb` instruction fills `Buffer` with zeros. By changing only the value assigned to `cx`, this same sequence can fill up to 65,535 bytes. (Set `cx` to `0FFFFh` to repeat a string instruction this maximum number of times. To fill 65,536 bytes, add an additional `stosb` instruction after `rep stosb`.)

Scanning Strings

Use `scas` to scan strings for specific values. As with other string instructions, you can use the longhand or shorthand forms `scasb` and `scasw`. Each repetition of `scas` compares the byte value in `al` or the word value in `ax` with the data addressed by `es:di`. Register `di` is then incremented or decremented by 1 or 2.

Because you can compare single bytes and words with a `cmp` instruction, the scan instructions are almost always prefaced with `repe` (repeat while equal) or `repne` (repeat while not equal)—or with the mnemonic aliases `repz` (repeat while `zf = 1`) and `repnz` (repeat while `zf = 0`). For each repetition, these prefixes decrement `cx` by 1, ending if `cx` becomes 0. (Remember that `repe`, `repz`, and `rep` are the same instruction.) When these prefixes are used with `scas` or `cmps` (or any of their shorthand equivalents), repetitions also stop when the zero flag `zf` indicates the failure of the scan or the compare. For example, a simple sequence scans 250 bytes looking for a 0:

```

cld                     ; Auto-increment di
mov di, OFFSET Start   ; Address starting Location with es:di
mov cx, 250             ; Set cx to maximum count
xor al, al              ; Set al = 0, the search value
repne scasb            ; Scan memory for a match with al
je MatchFound          ; Jump if a 0 was found at es:di - 1

```

After clearing `df` with `cld`, causing `scasb` to auto-increment `di`, which is initialized to address the label `Start`, `cx` is loaded with the maximum number of bytes to scan, 250. Then, `al` (holding the search value) is zeroed with an `xor` instruction. The `repne scasb` instruction scans up to 250 bytes decrementing `cx` after each repetition, and cycling while `cx` is not 0

and while `zf` indicates that a match has *not* been found. (You would use `repe` or `repz` to cycle until a mismatch is found.) After the repeated scan, an original `je` jumps to `MatchFound` (not shown) only if the search byte was located. The address of that byte is at `es:di-1`.

When Zero Means Zero

If `cx` equals 0, repeated string instructions cycle 65,536 times. But when you want 0 to mean “perform this operation zero times,” you must test whether `cx` is 0 before starting the repeated string instruction. You could do this with an `or` followed by a jump:

```

    or  cx, cx      ; Does cx = 0?
    jz  Skip       ; Jump if yes (cx = 0)
    rep stosb     ; Else repeat stosb

```

`Skip:`

This sequence jumps to label `Skip` if `cx` is 0. Only if `cx` is not 0 does the `rep stosb` instruction execute. This prevents accidentally repeating the string operation 65,536 times—unless, of course, that’s what you want to do. Instead of this sequence, however, you can use a special conditional jump instruction provided for this purpose.

```

    jcxz Skip      ; Jump if cx = 0
    rep stosb     ; Else repeat stosb

```

`Skip:`

The `jcxz` instruction performs the same function as the `or` and `jz` instructions in the previous example.

Comparing Strings

To compare two strings, use `cmps` or the shorthand forms `cmpsb` and `cmpsw`. The instructions compare two bytes or words at `es:di` and `ds:si` or `es:si`. As Table 4.9 shows, the operands are reversed from the similar operands for `movs`—an important distinction to keep in mind. The `cmps` comparison subtracts the byte or word at `es:di` from the byte or word at `ds:si` or `es:si`, saving the flags of this subtraction but not the result—similar to the way `cmp` works. After the comparison, both `si` and `di` are incremented or decremented by 1 for byte compares and by 2 for word compares. These instructions are almost always prefaced with a repeat prefix as in this sample:

```

cld                ; Auto-increment si, di
mov  si, OFFSET s1 ; Address first string with ds:si
mov  di, OFFSET s2 ; Address second string with es:di
mov  cx, strlen    ; Assign string length to cx
repe cmpsb        ; Compare the two strings
jb  Less          ; Jump if s1 < s2
ja  Greater       ; Jump if s1 > s2
je  Equal         ; Jump if s1 = s2

```

This sequence assumes that string `s1` is stored in the segment addressed by `ds` and that string `s2` is stored in the segment addressed by `es`. If `ds = es`, then the two strings would have to be stored in the same segment. After the initializing steps—clearing `df` with `cld`, assigning the

string addressed to `si` and `di`, and setting `cx` to the maximum number of bytes to compare—the `repe cmpsb` repeated string instruction compares the two strings, ending on the first mismatched byte found. (You could also use `repne` here to compare two strings, ending on the first match found.) After the repeated instruction, the flags indicate the final result, which you can test by any of the three conditional jumps as shown here.

NOTE

The string comparison method shown in the previous sample requires knowing the length of the strings being compared. If the strings are of different lengths, you must set `cx` to the number of characters in the shorter string. When it's not practical to calculate the string lengths ahead of time, different methods are required to compare strings. Chapter 5 describes these techniques in more detail.

Summary

Segments divide the 8086's large address space into manageable 64K-maximum size chunks, allowing programs to address memory using efficient 16-bit pointers. Segment registers point to the start of segments in memory. Segments can overlap and can begin at any 16-byte paragraph boundary.

There are five categories of registers in the 8086 design: the general-purpose registers (`ax`, `bx`, `cx`, `dx`), the pointer and index registers (`sp`, `bp`, `si`, `di`), the segment registers (`cs`, `ds`, `ss`, `es`), the instruction pointer (`ip`), and the flags (`of`, `df`, `if`, `tf`, `sf`, `zf`, `af`, `pf`, `cf`). Some registers have specific purposes; others are free to be used however you wish.

Six main groups divide the 8086 instruction set into data transfer instructions, arithmetic instructions, logic instructions, flow-control instructions, processor control instructions, and string instructions. Many instructions require one or two operands, usually labeled the destination and the source. Other instructions require no operands.

Stacks in memory resemble a stack of dishes where the last dish placed onto the stack is the first to be removed. This is known as a LIFO (Last-In-First-Out) structure. In the 8086 the `ss:sp` register pair locates the base and top of stack in memory. Programs use the `STACK` directive to allocate stack space at run time.

Subroutines help divide a large program into modules. Programs run subroutines with `call` instructions. Subroutines must end with a `ret` instruction to return to the instruction following the `call`. By using the `PROC` and `ENDP` directives around subroutine code, Turbo Assembler automatically assembles the correct calls and returns for intrasegment (same `cs`) and intersegment (different `cs`) subroutines.

Jump instructions change program flow, altering which instruction is to execute next. There are two kinds of jump instructions, conditional and unconditional. Conditional jump target addresses are limited to about 127 bytes away. The unconditional `jmp` instruction has no range limit.

Exercises

- 4.1. What are the minimum and maximum sizes of a memory segment for the 8086 processor?
- 4.2. List several ways to set register `ax` equal to 0.
- 4.3. Using `push` and `pop`, how can you duplicate the effect of the instruction `mov ax, dx`?
- 4.4. Describe the difference between `neg` and `not`.
- 4.5. What combination of instructions can rotate a 16-bit register enough times to restore completely the original value in that register? Which shift or rotate instructions will also preserve the value of the carry flag?
- 4.6. Write a routine to unpack two 4-bit values from an 8-bit byte into two 8-bit bytes. For example, if the original value equals 5F hexadecimal, then the two results should equal 05 and 0F. Assume that the original value is in register `ah` and that the result is to be stored in `dh` and `d1`.
- 4.7. How might you use a shift instruction to test whether a certain bit, say number 5, is set in register `dh`?
- 4.8. Suppose that the label `Target` is farther away than the conditional jump `j1` can reach. How can you recode the following instruction to avoid an error from Turbo Assembler?

```
j1 Target ; Jump to Target if Less
```
- 4.9. Without using `neg` or `not`, write instructions to form the one's and two's complements of values in `bx`.
- 4.10. Write your own `nop` instruction. No registers or flags should change by executing your custom `nop`. Can you find more than one way to do nothing? (Your answer can take more than a single byte of assembled code.)
- 4.11. What do string repeat prefixes do?
- 4.12. What instructions would you use to scan 65,536 bytes of memory?

Jump instructions change program flow, altering which instruction is to execute next. There are two kinds of jump instructions, conditional and unconditional. Conditional jump target addresses are limited to about 127 bytes away. The unconditional `jmp` instruction has no range limit.

Exercises

- 4.1. What are the minimum and maximum sizes of a memory segment for the 8086 processor?
- 4.2. List several ways to set register `ax` equal to 0.
- 4.3. Using `push` and `pop`, how can you duplicate the effect of the instruction `mov ax, dx`?
- 4.4. Describe the difference between `neg` and `not`.
- 4.5. What combination of instructions can rotate a 16-bit register enough times to restore completely the original value in that register? Which shift or rotate instructions will also preserve the value of the carry flag?
- 4.6. Write a routine to unpack two 4-bit values from an 8-bit byte into two 8-bit bytes. For example, if the original value equals 5F hexadecimal, then the two results should equal 05 and 0F. Assume that the original value is in register `ah` and that the result is to be stored in `dh` and `d1`.
- 4.7. How might you use a shift instruction to test whether a certain bit, say number 5, is set in register `dh`?
- 4.8. Suppose that the label `Target` is farther away than the conditional jump `j1` can reach. How can you recode the following instruction to avoid an error from Turbo Assembler?

```
j1 Target      ; Jump to Target if Less
```
- 4.9. Without using `neg` or `not`, write instructions to form the one's and two's complements of values in `bx`.
- 4.10. Write your own `nop` instruction. No registers or flags should change by executing your custom `nop`. Can you find more than one way to do nothing? (Your answer can take more than a single byte of assembled code.)
- 4.11. What do string repeat prefixes do?
- 4.12. What instructions would you use to scan 65,536 bytes of memory?

Jump instructions change program flow, altering which instruction is to execute next. There are two kinds of jump instructions, conditional and unconditional. Conditional jump target addresses are limited to about 127 bytes away. The unconditional `jmp` instruction has no range limit.

Exercises

- 4.1. What are the minimum and maximum sizes of a memory segment for the 8086 processor?
- 4.2. List several ways to set register `ax` equal to 0.
- 4.3. Using `push` and `pop`, how can you duplicate the effect of the instruction `mov ax, dx`?
- 4.4. Describe the difference between `neg` and `not`.
- 4.5. What combination of instructions can rotate a 16-bit register enough times to restore completely the original value in that register? Which shift or rotate instructions will also preserve the value of the carry flag?
- 4.6. Write a routine to unpack two 4-bit values from an 8-bit byte into two 8-bit bytes. For example, if the original value equals 5F hexadecimal, then the two results should equal 05 and 0F. Assume that the original value is in register `ah` and that the result is to be stored in `dh` and `d1`.
- 4.7. How might you use a shift instruction to test whether a certain bit, say number 5, is set in register `dh`?
- 4.8. Suppose that the label `Target` is farther away than the conditional jump `j1` can reach. How can you recode the following instruction to avoid an error from Turbo Assembler?

```
j1 Target          ; Jump to Target if Less
```
- 4.9. Without using `neg` or `not`, write instructions to form the one's and two's complements of values in `bx`.
- 4.10. Write your own `nop` instruction. No registers or flags should change by executing your custom `nop`. Can you find more than one way to do nothing? (Your answer can take more than a single byte of assembled code.)
- 4.11. What do string repeat prefixes do?
- 4.12. What instructions would you use to scan 65,536 bytes of memory?

Projects

- 4.1. Write a subroutine to unpack any number of bits from a word, returning those bits in the lower portion of a register. In other words, the caller to this subroutine should be able to pass a value containing bits, say, in positions 4, 5, and 6. The subroutine should return those bits in positions 0, 1, and 2, setting all other bits to 0.
- 4.2. Write a subroutine to do the reverse of Project 4.1. That is, the routine should be able to pack any number of bits into a certain position in a word, without disturbing other bits already there.
- 4.3. Create templates on disk for your future programs and procedures. Decide what information you will place in your subroutine headers.
- 4.4. Write a subroutine to scan memory for a specific byte value, stopping if that byte is not found within a certain number of memory locations. Use string instructions from Table 4.8.
- 4.5. Write subroutines to copy blocks of memory from one location to another, correctly handling variables in the same or in different segments. Use string instructions in your answer.
- 4.6. Write a routine to change all the characters in an ASCII string to uppercase or lowercase. Write your answer with and without string instructions.

5

CHAPTER

Simple Data Structures

- Addressing Data in Memory, 144
- Memory-Addressing Modes, 145
- Expressions and Operators, 152
- Simple Variables, 152
- Initialized vs Uninitialized Data, 155
- String Variables, 157
- Local Labels, 159
- An ASCIIZ String Package, 160
- Programming in Pieces, 170
- A String I/O Package, 173
- Linking Modules into a Program, 179
- Exploring the Strings Module, 182
- Summary, 193
- Exercises, 194
- Projects, 195

Addressing Data in Memory

Of all the subjects in 8086 assembly language programming, the many ways of addressing data in memory are probably some of the most difficult to learn. But you'll avoid a lot of head scratching if you remember that all data references take one of these three forms:

- Immediate data references
- Register data references
- Memory data references

Immediate data are values stored directly in the machine code of an instruction. For example, when you write:

```
mov ax, 5 ; ax <- 5
```

the assembler generates a machine-code variant of the `mov` instruction that loads the *immediate* value 5 into `ax`. The 5 is stored directly in the `mov` instruction's assembled machine code. In most cases, immediate data is the only operand or is the second of two operands. (An exception is `out`, which allows immediate data as the first of two operands.) You can never change the value of immediate data when the program runs.

NOTE

You can, of course, write programs to change machine-code instructions stored in memory. Using this technique, you could locate the place where an immediate value is stored and change it before the instruction operates. Pulling this trick is generally considered to be bad form. Such *self-modifying* code is often difficult to debug and, worse, cannot be stored in ROM, where memory values are permanently etched in silicon. Also, because the 8086 family processors preloads several instructions at once into a small amount of internal memory called the *instruction cache*, modifying code on-the-fly is unreliable at best. Resist the temptation to write self-modifying programs. There are few times (if any) when the results are worth the risks.

Register data refers to data held in processor registers. You've already seen many examples of this kind of data reference. The machine code generated by the assembler for register data includes appropriate values to cause the instruction to operate on the specified registers, as in:

```
add ax, bx ; ax <- ax + bx
```

Memory data is the third kind of data reference, of which there are several variations. To avoid confusion when learning these variants, remember that the goal is to help the processor calculate a 16-bit, unsigned value called the *effective address*, or EA. The EA represents an offset

starting from the base of a segment addressed by one of the four segment registers: `cs`, `ds`, `es`, and `ss`. As you recall from Chapter 4, “Programming in Assembly Language,” a segment register and offset form a 32-bit logical address, which the 8086 further translates into a physical 20-bit address, uniquely locating any byte in memory.

You never have to be concerned about calculating an EA or forming the physical 20-bit address—these are the processor’s jobs. Your responsibility is to give the processor the data necessary to calculate the EA, locating your variables in memory. To do this, you can use one of seven memory modes, as described next.

NOTE

Chapter 16’s Assembly Language reference lists the memory-addressing modes available for each instruction. Consult this reference when you are unsure whether an instruction recognizes a specific mode.

Memory-Addressing Modes

Table 5.1 lists the seven memory-addressing modes available in 8086 programming. Except for string and I/O port addressing, which have special requirements, these addressing modes can be used in all instructions that allow referencing data in memory. For instance, although the `mov` instruction is used in the examples in Table 5.1, you can use similar references with other instructions such as `add`, `inc`, and `xor`. The following sections describe the first five addressing modes, leaving string and I/O port addressing for later.

Table 5.1. 8086 Addressing Modes.

<i>Addressing Mode</i>	<i>Example</i>
Direct	<code>mov ax, [count]</code>
Register-indirect	<code>mov ax, [bx]</code>
Base	<code>mov ax, [record + bp]</code>
Indexed	<code>mov ax, [array + si]</code>
Base-indexed	<code>mov ax, [recordArray + bx + si]</code>
String	<code>lodsw</code>
I/O Port	<code>in ax, dx</code>

Direct Addresses

A *direct address* is the literal offset address of a variable in memory, relative to any segment base. For example, to refer to variables in the data segment, you can write instructions such as:

```
inc    [MyMoney]          ; Add 1 to value of [MyMoney]
```

The notation `[MyMoney]` is assembled to the offset address where the variable `MyMoney` is stored. All such direct address references are permanently fixed in the assembled code and can't be changed by a running program. (Self-modifying programs can change a direct address reference, but, for the reasons already described, this is a poor and unreliable technique.)

NOTE

Only the offset address of a direct memory reference is cut into stone. The segment in which the variable `MyMoney` is stored may begin at any paragraph boundary; therefore, there's no guarantee that `MyMoney` will be stored at a specific physical address.

Overrides

Direct address references are normally relative to the segment addressed by `ds`. To change this, you can specify a *segment override* as in:

```
mov    ch, [es:OverByte]
```

This instruction loads a byte at the label `OverByte` stored in the segment addressed by `es`. The override instruction `es:` is required to defeat the processor's normal use of the default segment base in `ds`. You can apply similar overrides to access data in other segments, too. Here are three more examples:

```
mov    dh, [cs:CodeByte]    ; dh ← byte in code segment
mov    dh, [ss:StackByte]   ; dh ← byte in stack segment
mov    dh, [ds:DataByte]    ; dh ← byte in data segment ???
```

The first line loads into `dh` a byte located in the code segment. Because most variables will be in a data segment, referring to data stored in the code segment is only occasionally useful. The second line loads a byte located in the stack segment. While permissible, this is rarely done in practice. The third line unnecessarily specifies `ds`—direct data references normally refer to the segment addressed by `ds`. Here are a few additional hints that will help you to use overrides correctly:

- Even though you specify an override as part of the data reference, an override actually occupies a byte of machine code and is inserted just before the affected instruction. Overrides are instruction prefixes that change the behavior of the next instruction to be executed.
- The effect of an override lasts for only one instruction. You must use an override in every reference to data in a segment other than the default segment for this instruction.
- In Turbo Assembler's Ideal mode, the entire address reference including the segment override must be in brackets. Although MASM mode allows a more free-form style, Ideal mode's clearer syntax requirements are fully compatible with MASM mode.
- It is your responsibility to ensure that variables are actually in the segments you specify and that segment registers `es` and `ds` are initialized to address those segments. Stack `ss` and code segment `cs` registers do not require initialization.

Register-Indirect Addresses

Instead of referring to variables in memory by name, you can use one of three registers as a pointer to data in memory: `bx`, `si`, and `di`. Because a program can modify register values to address different memory locations, *register-indirect addressing* allows one instruction to operate on multiple variables. After loading an offset address into an appropriate register, you can refer to the data stored in memory with instructions such as:

```
mov cx, [WORD bx]      ; Copy word at [bx] into cx
dec [BYTE si]         ; Decrement byte at [si]
```

The `WORD` and `BYTE` operators are required when Turbo Assembler is unable to determine whether the register addresses a word or a byte in memory. In the first line here, data addressed by `bx` is moved into the 16-bit register `cx`; therefore, the `WORD` operator is not needed because the assembler knows the size of the data reference from the context of the instruction. Specifying the operator as in this sample does no harm, though. In the second line, the `BYTE` operator must be included because the assembler has no other way of knowing whether `dec` is to decrement a byte or a word.

NOTE

In instructions such as `inc [si]`, Turbo Assembler displays a warning but still assembles the program, assuming that `si` addresses a word in memory even if this is not what you intend. Always use the `WORD` and `BYTE` operators to remove all addressing ambiguities and to reduce the likelihood of introducing hard-to-find bugs.

Register-indirect addressing defaults to the segment addressed by `ds`. As with direct addressing, you can use overrides to change this default to any of the other three segments. A few examples make this clear:

```
add  [WORD es:bx], 3      ; Add 3 to word at es:bx
dec  [BYTE ss:si]        ; Decrement the byte at ss:si
mov  cx, [cs:di]         ; Load a word from code segment
```

As explained earlier, when using overrides this way, you must be sure that the data you are addressing actually exists in the segments you specify. And, even though overrides to the stack segment as in the second sample are allowed, they are rarely of much practical use.

NOTE

String instructions use `es` as the default segment register for index `di`. Register-indirect addressing uses `ds` as the default segment for `di`. Don't confuse those two completely different addressing modes, even though they use the same index register.

Base Addresses

Base addressing employs the two registers `bx` and `bp`. References to `bx` are relative to the data segment addressed by `ds`. References to `bp` are relative to the stack segment `ss` and are normally used to read and write values stored on the stack. You can use segment overrides as previously described to refer to data in any of the other segments.

Base addressing adds a *displacement* value to the location addressed by `bx` or `bp`. This displacement is a signed 16- or 8-bit value representing an additional offset above or below the offset in the specified register. A typical use for base addressing is to locate fields in a data structure. For example:

```
mov  bx, OFFSET Person      ; Point to start of Person
mov  ax, [bx + 5]           ; Get data 5 bytes beyond
```

After assigning to `bx` the offset address of a variable named `Person` (not shown), a second `mov` loads into `ax` a value stored 5 bytes from the start of `Person`. Similarly, you can use instructions to reference variables on the stack, as in:

```
inc  [WORD bp + 2]          ; Increment word on stack
dec  [BYTE bp - 8]         ; Decrement byte on stack
```

Remember that references to `bp` are relative to the stack segment `ss`. (Chapters 12, "Mixing Assembly Language with Pascal," and 13, "Mixing Assembly Language with C and C++," describe in more detail how to use `bp` and base addressing to access stacked variables.) The displacement value may also be negative as the second line shows. Because displacements are 16-bit values, the effective range is $-32,768$ to $32,767$ bytes away from the offset addressed by `bx` or `bp`.

NOTE

When the displacement is 0, base addressing is identical to register-indirect addressing for register *bx*. Knowing this, Turbo Assembler reduces references such as `[bx + 0]` to the more efficient `[bx]` (no displacement). The same is not true for references that use *bp* as in `[bp + 0]` for which `[bp]` is merely a synonym, not a different addressing mode. (Some references confuse this point and list *bp* as a register-indirect mode register, although this is technically incorrect.)

Indexed Addresses

Indexed addressing is identical to base addressing except that *si* and *di* hold the offset addresses. Unless you specify a segment override, all indexed address references are relative to the data segment addressed by *ds*. Normally, indexed addressing is used to access simple arrays. For example, to increment the fifth byte of an array of 8-bit values, you can write:

```
inc [BYTE si + 4] ; Add 1 to array element number 5
```

Because `si + 0` locates the first array element, a displacement of 4 and not 5 must be used to locate the fifth byte in the array. Also, as with base addressing, displacements are signed values and, therefore, can be negative:

```
mov dx, [WORD di - 8] ; Load word 8 bytes before di
```

NOTE

When the displacement is 0, base addressing is identical to register-indirect addressing for the two registers *si* and *di*. Knowing this, Turbo Assembler reduces references such as `[si + 0]` and `[di + 0]` to the more efficient register-indirect equivalents, `[si]` and `[di]`.

Base-Indexed Addresses

Base-indexed addressing combines two registers and adds an optional displacement value to form an offset memory reference—thus coupling the features of the base- and indexed-addressing modes. The first register must be either *bx* or *bp*. The second register must be *si* or *di*. Offsets in *bx* are relative to the *ds* data segment; offsets in *bp* are relative to the *ss* stack segment. As with other addressing modes, you can use overrides to alter these defaults. A few examples help explain this valuable addressing technique:

```
mov ax, [bx + si] ; Load data segment word into ax
mov ax, [bx + di] ; " " " " " "
```

```
mov ax, [bp + si] ; Load stack segment word into ax
mov ax, [bp + di] ; " " " "
```

Turbo Assembler allows you to reverse the order of the registers, for example, writing `[si + bx]` and `[di + bp]`. But these are not different addressing modes—just different forms of the same references. You can also add an optional displacement value to any of the four previous variations:

```
mov ax, [bx + si + 5] ; Load displaced data segment word into ax
mov ax, [bx + di + 5] ; " " " "
mov ax, [bp + si + 5] ; Load displaced stack segment word into ax
mov ax, [bp + di + 5] ; " " " "
```

In addition, you can add overrides to any of these eight basic base-indexed addressing variants to refer to data in segments other than the defaults:

```
mov ax, [es:bx + si + 8] ; Use es instead of ds default
mov ax, [cs:bp + di] ; Use cs instead of ss default
```

Base-indexed addressing is the 8086's most powerful memory reference technique. With this method, you can specify a starting offset in `bx` or `bp` (perhaps the address of an array), add to this an index value in `si` or `di` (possibly locating one element in the array), and then add a displacement value (maybe to locate a record field in this specific array element). By modifying the base and index register values, programs can address complex data structures in memory.

NOTE

In MASM mode, base-indexed address references (and other addressing methods) can have a more free-form appearance such as `5[bx + si]` and `5[bp][di]`, leading many people to assume that these are unique and mysterious addressing forms. This is not so. There are only eight basic forms of base-indexed addressing, as listed earlier. You'll avoid much confusion (and lose nothing in the process) if you stick to the standard forms described here and required by Ideal mode.

Using the ASSUME Directive

An `ASSUME` directive tells Turbo Assembler to which segment in memory a segment register refers. The purpose of `ASSUME` is to allow the assembler to insert override instructions automatically when needed. Always remember that `ASSUME` is a command to the assembler and does not generate any code.

When using simplified segment addressing—as in most of this book's examples—you'll rarely need to use `ASSUME`. And, by explicitly using segment overrides, you can eliminate the need for `ASSUME` altogether. Even so, it pays to understand how this directive works. Suppose you write:

```
CODESEG
    jmp There ; Skip declaration of v1
v1 db 5 ; Store a 5 in the code segment
There:
    mov ah, [cs:v1] ; Load 5 into ah
```

This code snippet illustrates one way to store data inside the code segment—an unusual but allowable practice. The `jmp` instruction skips over the declaration of a byte variable `v1`. (When mixing data and code, you certainly don't want to accidentally execute your variables as though they were instructions.) The `mov` instruction uses a segment override (`cs:`) to load the value of `v1` into `ah`. The override is required because direct data references normally default to the `ds` data segment.

Because Turbo Assembler knows that `cs` refers to the code segment, it allows you to replace the `mov` instruction with the simpler instruction:

```
mov ah, [v1] ; Load 5 into ah from code segment
```

Even though an explicit override is not used, Turbo Assembler checks its list of variables, detects that `v1` is stored in the code segment, and *automatically inserts the required override*. In other cases when Turbo Assembler doesn't know which segment registers refer to which memory segments, you must either use an explicit override or tell the assembler what's going on with an `ASSUME` directive. Here's another example:

```
CODESEG
    jmp There ; Skip declaration of v1
v1 db 5 ; Store a 5 in this Location
There:
    mov ax, @code ; Assign address of code segment
    mov es, ax ; to es register
ASSUME es:_TEXT
    mov ah, [v1] ; Load 5 into ah from extra segment
```

Again, a 5 byte is stored directly in the code segment. In this example, segment register `es` is initialized to address the code segment, assigning the predefined symbol `@code` to `ax` and then assigning this value to `es`. The `ASSUME` directive tells Turbo Assembler where `es` now points, using the small memory model's name for the code segment `_TEXT`. Finally, the `mov` loads the value of `v1` into `ah`. Although this appears identical to the earlier example, because of the `ASSUME` directive, the actual instruction assembled is:

```
mov ah, [es:v1]
```

Because `v1` is stored in the code segment, however, both `[es:v1]` and `[cs:v1]` correctly locate the same variable. All that `ASSUME` does is allow the assembler to insert the override instructions automatically.

NOTE

Segment names such as `_TEXT` are listed with the `MODEL` directive in your Turbo Assembler Reference Guide. Using simplified memory models as explained in Chapter 2, "First Steps", usually makes it unnecessary to refer to these names or to use `ASSUME` directives.

Expressions and Operators

Expressions in assembly language have one purpose: to make programs easy to understand and, therefore, easy to modify. For example, you might have several equates, associating optional values with symbols such as:

```
RecSize EQU 10
NumRecs EQU 25
```

Elsewhere you can use the equated symbols in expressions, perhaps to store in memory a value equal to `RecSize` times `NumRecs`:

```
BufSize dw RecSize * NumRecs
```

When Turbo Assembler processes this directive, it multiplies `RecSize` by `NumRecs` and stores the resulting constant (250) in the word variable `BufSize`. It's important to understand that this calculation occurs during assembly—not when the program runs. All expressions evaluate to constants in the assembled code. In high-level languages, expressions such as `(Columns * 16)` are evaluated at runtime, possibly with a new value for a variable named `Columns` entered by an operator. In assembly language, expressions reduce to constant values when you assemble the program text, not when the program runs. The difference can be confusing at first, especially if you're more accustomed to high- than low-level programming.

Table 5.2 lists Turbo Assembler's Ideal-mode expressions operators, which you can use to calculate constant values of just about any imaginable type. MASM-mode operators (listed in Turbo Assembler's Reference Guide) are similar. Don't confuse operators such as `AND`, `OR`, `XOR`, and `NOT` with the assembly language mnemonics of the same names. The assembly language mnemonics are instructions that operate at runtime. The operators are for use in expressions, calculated at assembly time. In this and in other chapters, you'll meet many of these operators in action.

Simple Variables

Earlier program examples in this book created simple variables with `db` and `dw` directives. These directives belong to a family of similar commands, all having the same general purpose: to define (meaning to reserve) space for values in memory. The directives differ only in how much space they can define and the types of initial values you can specify. Table 5.3 lists all seven of these useful directives ranked according to the minimum amount of space each reserves. Also listed are typical examples, although the directives are not limited to the uses shown here. You can type any of these directives in uppercase or lowercase. `DB` and `db` have the same meaning.

Wide Open Spaces

To create large amounts of space, you can string together several `db`, `dw`, or other define-memory directives, or you can use the `DUP` operator, which is usually more convenient. `DUP` has the following form:

```
[Label] directive count DUP (expression [,expression]...)
```

Table 5.2. Expression Operators.

<i>Operator</i>	<i>Description</i>	<i>Operator</i>	<i>Description</i>
()	Parentheses	LT	Less than
*	Multiply	MASK	Record-field bit mask
/	Divide	MOD	Division remainder
+	Add/unary plus	NE	Not equal
-	Subtract/unary minus	NEAR	Near code pointer
.	Structure member	NOT	One's complement
:	Segment override	OFFSET	Offset address
?	Uninitialized data	OR	Logical OR
[]	Memory reference	PROC	Near/far code pointer
AND	Logical AND	PTR	Expression size
BYTE	Force byte size	PWORD	32-bit far pointer
CODEPTR	Procedure address size	QWORD	Quadword size
DATAPTR	Model-dependent size	SEG	segment address
DUP	Duplicate variable	SHL	Shift left
DWORD	Force doubleword	SHORT	Short code pointer
EQ	Equal	SHR	Shift right
FAR	Far code pointer	SIZE	Size of item
FWORD	Farword size	SMALL	16-bit offset
GE	Greater than or equal	SYMTYPE	Symbol type
GT	Greater than	TBYTE	Ten-byte size
HIGH	Return high part	THIS	Refer to next item

continues

Table 5.2. continued

<i>Operator</i>	<i>Description</i>	<i>Operator</i>	<i>Description</i>
LARGE	Force 32-bit offset	TYPE	Type of item
LE	Less than or equal	UNKNOWN	Remove type info
LENGTH	Number of elements	WIDTH	Bit field width
LOW	Low part	WORD	Word size
		XOR	Exclusive OR

Table 5.3. Define-Memory Directives.

<i>Directive</i>	<i>Name</i>	<i>Minimum Bytes Allocated</i>	<i>Typical Use</i>
db	Define byte	1	Bytes, strings
dw	Define word	2	Integers
dd	Define doubleword	4	Long integers
dp	Define pointer	6	32-bit pointer
df	Define far pointer	6	48-bit pointer
dq	Define quadword	8	Real numbers
dt	Define ten bytes	10	BCD numbers

To create a multibyte space, start with an optional label and a define-memory directive from Table 5.3. Follow this with a count equal to the number of times you want to duplicate an expression, which must be in parentheses. The DUP keyword goes between the count and the expression. For example, each of these directives reserves a 10-byte area in memory, setting all 10 bytes to 0:

```
Ten1   dt   0           ; Ten zero bytes
Ten2   db  10 DUP (0)  ; Same as above
```

Separating multiple expressions or constant values with commas duplicates each value in turn, increasing the total size of the space reserved by the count times the number of items. Despite a count of 10, therefore, the following directive creates a 20-byte variable—ten repetitions of the two bytes 1 and 2.

```
Twenty1 db 10 DUP (1,2) ; 20 bytes--1, 2, 1, 2, ..., 2
```

You can also nest DUP expressions to create large buffers initialized to a constant value. For example, each of the following directives reserves a 20-byte area with all bytes equal to 255:

```
Twenty2 db 10 DUP (2 DUP (255)) ; 20 bytes of 255
Twenty3 db 20 DUP (255) ; Same as above
```

These same examples work with any of the define-memory directives to reserve different amounts of space. Most often, though, you'll use `db` and `dw` for integer, string, and byte variables, putting the other directives to work only for the special purposes listed in Table 5.3. But you are free to use these directives as you please. To create a 20-byte variable of all zeros, for example, you could use `db` as before or `dt` like this:

```
Twenty4 dt 2 DUP (0)
```

Of all the define-memory directives, only `db` has the special ability to allocate space for character strings, storing one ASCII character per byte in memory. Here's a sample, ending in a zero byte, a typical construction called an *ASCII string*:

```
Astring db 'String things', 0
```

Combining `db`'s string ability with the DUP operator is a useful trick for filling a buffer with text that's easy to locate in Turbo Debugger's dump window. You might code a 1,024-byte buffer as:

```
Buffer db 128 DUP ('=Buffer=') ; 1024 bytes
```

DUP repeats the 8-byte string in parentheses 128 times, thus reserving a total of 1,024 bytes. In Turbo Debugger, use the `view-Dump` command, zoom to full screen with F5, press Alt-F10, and select Goto to view the program's data segment at DS:0000. Then use the PgDn key to hunt for this or a similar buffer in memory. There are other ways to find variables with Turbo Debugger, but this age-old debugging method is still a useful trick.

Initialized Versus Uninitialized Data

When you know your program is going to assign new values to variables and, therefore, don't care what the initial values are, you can define uninitialized variables—those that have no specific values when the program runs. To do this, use a question mark (?) in place of the define-memory constant:

```
stuff db ? ; Byte of unknown value
moreStuff dw ? ; Word of unknown value
anyStuff dt ? ; Ten bytes of unknown values
```

To create larger uninitialized spaces, use a question mark inside a DUP expression's parentheses, a useful technique for creating big buffers such as:

```
BigBuf db 8000 DUP (?) ; 8000-byte buffer
```

The 8,000-byte buffer created by this command contains bytes of no specific values when the program runs. Whatever was in the memory occupied by the buffer when DOS loads your program is what the buffer will contain.

NOTE

When assembling and linking programs with the commands `tasm /zi <filename>` and `tlink /v <filename>`, Turbo Debugger fills uninitialized data with zero bytes. Do not rely on this in the final program. When assembling and linking without these switches, uninitialized variables have indeterminate values.

The main reason for declaring uninitialized variables is to reduce the size of the assembled code file. Instead of storing useless bytes on disk, uninitialized space is allocated at run time. For this to work, you must follow one of two rules:

- Place all uninitialized variables last in the data segment
- Or preface uninitialized variables with `UDATASEG`

Usually, the easiest plan is to place uninitialized variables last in the data segment, after variables with initial values. When this isn't practical, use the `UDATASEG` directive to tell Turbo Assembler to relocate an uninitialized variable to the end of the last initialized variable in the data segment even though the uninitialized variable appears elsewhere in the program text. For example, you can write:

```
DATASEG
var1      db    1
var2      db    2
UDATASEG
array     db    1000 DUP (?)
DATASEG
var3      db    3
```

The `UDATASEG` directive places `array` after `var3` in memory, just as though you had declared the large uninitialized variable last instead of between the two initialized variables `var2` and `var3`. Without `UDATASEG`, the large array would be “trapped” between `var2` and `var3`, unnecessarily increasing the size of your code file by 1,000 bytes.

NOTE

Many public domain assembly language source-code listings contain uninitialized variables between other initialized variables. When you find such a program, try relocating the uninitialized variables to the end of the data segment. Chances are this will reduce the size of the assembled code file, sometimes dramatically.

Be careful when using `UDATASEG` not to assume that one variable physically follows another in memory, as variables normally do. Some programs expect variables to be ordered in memory the way they are declared in the program text and, in these cases, relocating the variables is a big mistake. Avoid this problem in your own programs—and add clarity to your source code—by organizing your data segment like this:

```
DATASEG
; initialized variables
UDATASEG
; uninitialized variables
```

String Variables

While `db` can create character-string variables, assembly language has no built-in character-string commands to read and write strings, to delete characters, or to compare one string with another. Listing 5.1 adds these and other routines to assembly language programs. But first, let's examine a few typical string formats.

Probably the most common string format is the *ASCII\$ string*—a series of ASCII characters ending in a dollar sign. Use `db` this way to create an ASCII\$ string:

```
myString    db    'Welcome to my program', '$'
```

You don't have to separate the dollar sign from the main string—you could just add `$` between the "m" and the closing single quote. Separating the characters as shown here emphasizes that the dollar sign is a string terminator—not just another character. To display this string, use DOS function `09`:

```
mov  dx, OFFSET myString    ; Address string with ds:dx
mov  ah, 09                 ; Specify DOS function 09
int  21h                    ; Call DOS to display string
```

The first line assigns the offset address of `myString` in the program's data segment addressed by `ds`. The `09` assigned to `ah` is the value of the DOS "Output character string" function, which `int 21h` activates. The `int` (software interrupt) instruction operates similarly to a subroutine `call` and, after DOS finishes executing the function specified in `ah`, returns control to your program starting with the instruction that follows `int 21h`. Chapter 10, "Interrupt Handling," discusses this and other kinds of interrupts in more detail.

NOTE

Consult the Bibliography for references that list other DOS functions that you can call in assembly language programs.

The major problem with ASCII\$ strings is obvious—there's no easy way to display a dollar sign! Also, it's difficult to read characters from the keyboard or from disk files into such strings. For these reasons, I rarely use ASCII\$ strings. Instead, I prefer ASCIIZ strings ending in a zero byte—the same format used by most high-level language C and C++ compilers. With ASCIIZ strings, you might create an error message by writing:

```
diskErr    db    "Disk read error!", 0
```

ASCIIZ strings can be as long as you need—from a single character up to thousands. The first byte at the string label is either an ASCII character or a zero byte, also called an ASCII *null character*. If the first is 0, then the string is empty. This fact leads to an easy way to create zero-length string variables with the DUP operator:

```
stringVar db    81 DUP (0)    ; 80-character string + null
```

When creating strings this way, always set the DUP count to one more than the maximum number of characters you plan to store in the string, leaving room for the null, which must always end the string. The only disadvantage of ASCIIZ strings is that DOS has no standard routines for reading and writing string variables in this format. The string packages later in this chapter fix this deficiency with routines that you can use to read and write ASCIIZ strings.

Quoting Quotes

For all strings declared with db, you can surround characters with either apostrophes (') or double quotes (") as long as you begin and end with the same symbols. In the ASCII character set, an apostrophe and a closing single quote are the same characters. On your keyboard and in this book, the symbols are printed with straight up and down lines. But on your display, depending on your operating system and text-editor character set, the single quote apostrophe symbol may hook down to the left.

NOTE

Don't surround strings with opening single quotes ('), usually created by pressing the key in the upper left corner of most PC keyboards. (On my laptop, however, this key is to the right of the space bar.) Opening quotes are not allowed as string delimiters.

To include a quote mark inside a string, you have several options. The easiest method is to use one type of quote mark around the character string containing the other type:

```
Quote     db    'When "quoting" speech, you can surround', 0
Unquote   db    "the text with 'quote marks' like this.", 0
```

The double quotes in the first string are inserted as characters. The single quotes in the second string are also inserted as characters. Another method is to repeat the same quote used as the string delimiter. This is useful for creating strings that contain both single and double quotes:

```
CrazyQuotes db 'This "string" contains four "quote" marks', 0
```

The repeated single quotes around the word *string* are inserted as single quote mark characters even though the entire string is delimited by these same characters. You can do the same with double quotes, too.

Local Labels

Up until now, program examples used code segment labels like `Start:` and `Repeat:`. Such labels are global to the entire program that declares them. In other words, if you label an instruction `Here:` at the beginning of the program, that label is available to `call`, `jmp`, and other instructions anywhere else throughout the code. One problem with this is that you constantly have to think up new names to avoid conflicts with labels you've already used. For short hops, this is a major inconvenience, as in this short sample:

```
    cmp ax, 9      ; Does ax = 9?
    je  SkipIt    ; Skip and below if ax = 9
    add cx, 10    ; Else add 10 to cx
SkipIt:
```

Short jumps such as the `je` to label `skipIt:` are common in assembly language programming. Most probably, no other instruction will need to jump to this same label; therefore `skipIt:` isn't needed beyond this one place. A large program might make hundreds or thousands of similar hops, requiring you to invent new names for each one! To reduce this burden, Turbo Assembler lets you create *local labels*, which exists only in the sections of code that need them.

A local label is identical to any other code label but begins with two *at-signs*, `@@`. Examples of local labels include such names as `@@10:`, `@@Here:`, `@@Tempo:`, and `@@x:`. The life of a local label extends only forward and back to the next nonlocal label. Because this includes labels defined in `PROC` directives, if you surround your procedures with `PROC` and `ENDP`, local labels in subroutines are visible only inside the routine's code. You can then reuse the same local labels elsewhere without conflict. An example helps make this clear:

```
    jmp There      ; Jump to global label
@@10:
    inc ax
    cmp ax, 10
    jne @@10      ; Jump to local label above
There:
    cmp ax, 20
    je  @@10      ; Jump to local label below
    xor cx, cx
@@10:
```

Don't try to run this example—it's just for illustration. The first `jmp` jumps to the global label `There:`—you can jump to global labels from anywhere in a program. The next `jne` jumps to local label `@@10:`. But, which one? There are two. The answer is, the first `@@10:`, which extends only down to the global label `There:`. Consequently, the `jne` can “see” only the first `@@10:`. For the same reason, the later `je` instruction jumps down to the second `@@10:` because the global `There:` above blocks the view of the first local label. Some advantages of local labels are:

- Local labels save memory by letting Turbo Assembler reuse RAM for other local labels. Global labels are permanently stored in memory during assembly, even if the labels are used only once. Local labels are thrown away every time a new nonlocal label is encountered.
- Local labels improve program clarity. For example, a quick scan of a program easily picks out the global and local labels.
- Local labels help reduce bugs by making it more difficult to write long-distance hops from one place in a program to another. If you surround your procedures with `PROC` and `ENDP` directives, you won't be tempted to jump to a temporary label in the midsection of a subroutine—a generally recognized source of bugs.

NOTE

Like global labels, local labels must end with colons as in `@@ABC:`. When an instruction refers to a local label, the label must not have a colon, as in `jmp @@ABC`.

An ASCIIZ String Package

Chapter 4 introduced the 8086 string instructions. Listing 5.1 (`STRING.ASM`) is a package of 12 ASCIIZ string routines, many of which put these string instructions to good use. Lines 18-29 list the names and give brief descriptions of the routines in the package, which is organized a little differently from listings you've seen up to now. `STRINGS.ASM` is a *library module* that you must assemble separately and then link with another program. Unlike previous program examples, the `STRINGS` module does not run on its own. Instead, as later examples demonstrate, `STRINGS` requires a host program to use the subroutines in the module. To assemble `STRINGS`, use the command:

```
tasm strings
```

Or, if you plan to use Turbo Debugger to examine programs that use the string package, use the command:

```
tasm /zi strings
```

Be aware that using the `/zi` option adds debugging information to the assembled code and, for this reason can make the finished code file swell—often enormously. Use the former command (without the `/zi` option) to reduce code-file size.

Whichever of the two commands you use, the result is a file named `STRINGS.OBJ`, containing the raw assembled code, ready to be linked into a host program. After the `STRINGS.ASM` listing are suggestions that describe how to do this. But, for the purposes of running other programs in this book, many of which require the `STRINGS` package, you need to store the `STRINGS.OBJ` code in a *library file*. Enter the following command, ignoring a probable warning that “`STRINGS [was] not found in [the] library:`”

```
tlib /E mta --strings
```

NOTE

If you don't have a hard disk drive, you might want to store `MTA.LIB` on your Turbo Assembler disk. If this disk is in drive A:, use the name `a:mta` instead of `mta` here and from now on. You can then assemble other programs and modules that require the code in `MTA.LIB` without worrying whether the necessary `.OBJ` files are available.

The result of the `tlib` command is a file named `MTA.LIB` (for “Mastering Turbo Assembler Library”) containing the `STRINGS` package. The `/E` option stores an *extended dictionary* in the library file, which helps to speed linking by providing `TLINK` with additional information about the library's symbols. The `--strings` command tells `TLIB` to replace any previous version of `STRINGS` with the new `.OBJ` code file. Later on, you'll add new object-code files to `MTA.LIB`, which will greatly reduce the complexity of assembling and linking programs that use routines in `STRINGS` and in other separately assembled modules. If you make any changes to the `STRINGS.ASM` listing, repeat the `tasm` and `tlib` commands to replace the old object code in the `MTA.LIB` file with the updated programming.

Listing 5.1. `STRINGS.ASM`.

```
1: %TITLE "String Procedures--Copyright 1989,1995 by Tom Swan"
2:
3:         IDEAL
4:
5:         MODEL    small
6:
7:         CODESEG
8:
9:         PUBLIC  MoveLeft, MoveRight, StrNull, StrLength
10:        PUBLIC  StrUpper, StrCompare, StrDelete, StrInsert
11:        PUBLIC  StrConcat, StrCopy, StrPos, StrRemove
12:
```

continues

Listing 5.1. continued

```

13: ;-----
14: ; Assemble with the command TASM STRINGS to create STRINGS.OBJ. To use
15: ; the procedures, add EXTRN <procedure>:PROC statements where
16: ; <procedure> is one of the following identifiers:
17: ;
18: ;      MoveLeft      -- memory move with increasing indexes
19: ;      MoveRight     -- memory move with decreasing indexes
20: ;      StrNull       -- erase all chars in string
21: ;      StrLength     -- return number of chars in string
22: ;      StrUpper      -- convert chars in string to uppercase
23: ;      StrCompare    -- alphabetically compare two strings
24: ;      StrDelete     -- delete chars from string
25: ;      StrInsert     -- insert chars into string
26: ;      StrConcat     -- attach one string to another
27: ;      StrCopy       -- copy one string to another
28: ;      StrPos        -- find position of substring in a string
29: ;      StrRemove     -- remove substring from a string
30: ;
31: ; After assembling your program, link with STRINGS.OBJ. For example,
32: ; if your program is named MYPROG, first assemble MYPROG to MYPROG.OBJ
33: ; and link with the command TLINK MYPROG+STRINGS to create MYPROG.EXE.
34: ;
35: ; STRING VARIABLES:
36: ; A string is a simple array of characters with one character per
37: ; eight-bit byte. A null character (ASCII 0) must follow the last
38: ; character in the string. An empty string contains a single null.
39: ; Declare string variables this way:
40: ;
41: ;      STRING DB      81 DUP (0)      ; 80-character string + null
42: ;
43: ; STRING CONSTANTS:
44: ; Always allow one extra byte for the null terminator. Character
45: ; constants (which may be used as variables) must be properly
46: ; terminated. For example:
47: ;
48: ;      C1      db      'This is a test string.', 0
49: ;
50: ; SEGMENT REGISTERS:
51: ; Routines in this package assume that ES and DS address the
52: ; same segment. Set ES=DS before calling any of these routines.
53: ;-----
54: ;
55: ASCNull      EQU      0              ; ASCII null character
56:

```

```

57: %NEWPAGE
58: ;-----
59: ; MoveLeft      Move byte-block left (down) in memory
60: ;-----
61: ; Input:
62: ;     si = address of source string (s1)
63: ;     di = address of destination string (s2)
64: ;     bx = index s1 (i1)
65: ;     dx = index s2 (i2)
66: ;     cx = number of bytes to move (count)
67: ; Output:
68: ;     count bytes from s1[i1] moved to the location
69: ;     starting at s2[i2]
70: ; Registers:
71: ;     none
72: ;-----
73: PROC      MoveLeft
74:     jcxz   @@99          ; Exit if count = 0
75:     push   cx           ; Save modified registers
76:     push   si
77:     push   di
78:
79:     add    si, bx       ; Index into source string
80:     add    di, dx       ; Index into destination string
81:     cld                    ; Auto-increment si and di
82:     rep    movsb        ; Move while cx <> 0
83:
84:     pop    di           ; Restore registers
85:     pop    si
86:     pop    cx
87: @@99:
88:     ret                    ; Return to caller
89: ENDP      MoveLeft
90: %NEWPAGE
91: ;-----
92: ; MoveRight     Move byte-block right (up) in memory
93: ;-----
94: ; Input:
95: ;     (same as MoveLeft)
96: ; Output:
97: ;     (same as MoveLeft)
98: ; Registers:
99: ;     none
100: ;-----
101: PROC      MoveRight
102:     jcxz   @@99          ; Exit if count = 0
103:     push   cx           ; Save modified registers
104:     push   di
105:     push   si
106:
107:     add    si, bx       ; Index into source string
108:     add    di, dx       ; Index into destination string
109:     add    si, cx       ; Adjust to last source byte
110:     dec    si
111:     add    di, cx       ; Adjust to last destination byte
112:     dec    di

```

Listing 5.1. continued

```

113:      std                ; Auto-decrement si and di
114:      rep   movsb        ; Move while cx <> 0
115:
116:      pop   si           ; Restore registers
117:      pop   di
118:      pop   cx
119: @@99:
120:      ret                ; Return to caller
121: ENDP   MoveRight
122: %NEWPAGE
123: ;-----
124: ; StrNull      Erase all characters in a string
125: ;-----
126: ; Input:
127: ;     di = address of string (s)
128: ; Output:
129: ;     s[0] <- null character (ASCII 0)
130: ; Registers:
131: ;     none
132: ;-----
133: PROC   StrNull
134:      mov   [byte ptr di], ASCNull ; Insert null at s[0]
135:      ret                ; Return to caller
136: ENDP   StrNull
137: %NEWPAGE
138: ;-----
139: ; StrLength    Count non-null characters in a string
140: ;-----
141: ; Input:
142: ;     di = address of string (s)
143: ; Output:
144: ;     cx = number of non-null characters in s
145: ; Registers:
146: ;     cx
147: ;-----
148: PROC   StrLength
149:      push  ax           ; Save modified registers
150:      push  di
151:
152:      xor   al, al       ; al <- search char (null)
153:      mov   cx, 0ffffh   ; cx <- maximum search depth
154:      cld                ; Auto-increment di
155:      repnz scasb        ; Scan for al while [di]<>null & cx<>0
156:      not   cx           ; Ones complement of cx
157:      dec   cx           ; minus 1 equals string length
158:
159:      pop   di           ; Restore registers
160:      pop   ax
161:      ret                ; Return to caller
162: ENDP   StrLength
163: %NEWPAGE

```

```

164: ;-----
165: ; StrUpper      Convert chars in string to uppercase
166: ;-----
167: ; Input:
168: ;     di = address of string to convert (s)
169: ; Output:
170: ;     lowercase chars in string converted to uppercase
171: ; Registers:
172: ;     none
173: ;-----
174: PROC      StrUpper
175:     push   ax           ; Save modified registers
176:     push   cx
177:     push   di
178:     push   si
179:     call  StrLength    ; Set cx = length of string
180:     jcxz  @@99         ; Exit if length = 0
181:     cld           ; Auto-increment si, di
182:     mov   si, di      ; Set si = di
183: @@10:
184:     lodsb           ; al <- s[si]; si <- si + 1
185:     cmp   al, 'a'    ; Is al >= 'a'?
186:     jb   @@20        ; No, jump to continue scan
187:     cmp   al, 'z'    ; Is al <= 'z'?
188:     ja   @@20        ; No, jump to continue scan
189:     sub   al, 'a'-'A' ; Convert lowercase to uppercase
190: @@20:
191:     stosb          ; s[di] <- al; di <- di + 1
192:     loop  @@10     ; cx <- cx - 1; loop if cx <> 0
193: @@99:
194:     pop   si           ; Restore registers
195:     pop   di
196:     pop   cx
197:     pop   ax
198:     ret            ; Return to caller
199: ENDP      StrUpper
200: %NEWPAGE
201: ;-----
202: ; StrCompare     Compare two strings
203: ;-----
204: ; Input:
205: ;     si = address of string 1 (s1)
206: ;     di = address of string 2 (s2)
207: ; Output:
208: ;     flags set for conditional jump using jb, jbe,
209: ;     je, ja, or jae.
210: ; Registers:
211: ;     none
212: ;-----
213: PROC      StrCompare
214:     push   ax           ; Save modified registers
215:     push   di
216:     push   si
217:     cld           ; Auto-increment si
218: @@10:
219:     lodsb          ; al <- [si], si <- si + 1
220:     scasb         ; Compare al and [di]; di <- di + 1

```

Listing 5.1. continued

```

221:         jne    @@20          ; Exit if non-equal chars found
222:         or     al, al         ; Is al=0? (i.e. at end of s1)
223:         jne    @@10          ; If no jump, else exit
224: @@20:
225:         pop    si             ; Restore registers
226:         pop    di
227:         pop    ax
228:         ret                    ; Return flags to caller
229: ENDP   StrCompare
230: %NEWPAGE
231: ;-----
232: ; StrDelete   Delete characters anywhere in a string
233: ;-----
234: ; Input:
235: ;         di = address of string (s)
236: ;         dx = index (i) of first char to delete
237: ;         cx = number of chars to delete (n)
238: ; Output:
239: ;         n characters deleted from string at s[i]
240: ;         Note: prevents deleting past end of string
241: ; Registers:
242: ;         none
243: ;-----
244: PROC    StrDelete
245:         push   bx             ; Save modified registers
246:         push   cx
247:         push   di
248:         push   si
249:
250: ; bx = SourceIndex
251: ; cx = Count / Len / CharToMove
252: ; dx = Index
253:
254:         mov    bx, dx         ; Assign string index to bx
255:         add    bx, cx         ; Source index <- index + count
256:         call   StrLength     ; cx <- length(s)
257:         cmp    cx, bx         ; Is length > index?
258:         ja     @@10          ; If yes, jump to delete chars
259:         add    di, dx         ; else, calculate index to string end
260:         mov    [byte ptr di], ASCNull ; and insert null
261:         jmp    short @@99     ; Jump to exit
262: @@10:
263:         mov    si, di         ; Make source = destination
264:         sub    cx, bx         ; CharToMove <- Len - SourceIndex
265:         inc    cx             ; Plus one for null at end of string
266:         call   MoveLeft      ; Move chars over deleted portion
267: @@99:
268:         pop    si             ; Restore registers
269:         pop    di
270:         pop    cx
271:         pop    bx
272:         ret                    ; Return to caller
273: ENDP   StrDelete
274: %NEWPAGE

```

```

275: ;-----
276: ; StrInsert      Insert a string into another string
277: ;-----
278: ; Input:
279: ;     si = address of string 1 (s1)
280: ;     di = address of string 2 (s2)
281: ;     dx = insertion index for s2 (i)
282: ;     NOTE: s2 must be large enough to expand by length(s1)!
283: ; Output:
284: ;     chars from string s1 inserted at s2[i]
285: ;     s1 not changed
286: ; Registers:
287: ;     none
288: ;-----
289: PROC      StrInsert
290:     push   ax           ; Save modified registers
291:     push   bx
292:     push   cx
293:
294: ; ax = LenInsertion
295: ; cx = CharsToMove
296:
297:     xchg   si, di       ; Exchange si and di
298:     call   StrLength    ; and find length of s1
299:     xchg   si, di       ; Restore si and di
300:     mov    ax, cx       ; Save length(s1) in ax
301:
302:     call   StrLength    ; Find length of s2
303:     sub    cx, dx       ; cx <- length(s2) - i + 1
304:     inc    cx           ; cx = (CharsToMove)
305:
306: ; bx = s1 index
307:
308:     push   dx           ; Save index (dx) and si
309:     push   si
310:     mov    si, di       ; Make si and di address s2
311:     mov    bx, dx       ; Set s1 index to dx (i)
312:     add    dx, ax       ; Set s2 index to i+LenInsertion
313:     call   MoveRight    ; Open a hole for the insertion
314:     pop    si           ; Restore index (dx) and si
315:     pop    dx
316:
317:     xor    bx, bx       ; Set s1 (source) index to zero
318:     mov    cx, ax       ; Set cx to LenInsertion
319:     call   MoveLeft     ; Insert s1 into hole in s2
320:
321:     pop    cx           ; Restore registers
322:     pop    bx
323:     pop    ax
324:     ret                ; Return to caller
325: ENDP      StrInsert
326: %NEWPAGE
327: ;-----
328: ; StrConcat      Concatenate (join) two strings
329: ;-----

```

continues

Listing 5.1. continued

```

330: ; Input:
331: ;     si = address of source string (s1)
332: ;     di = address of destination string (s2)
333: ;     Note: s2 must be large enough to expand by length(s1)!
334: ; Output:
335: ;     chars from s1 added to end of s2
336: ; Registers:
337: ;     none
338: ;-----
339: PROC     StrConcat
340:         push    bx                ; Save modified registers
341:         push    cx
342:         push    dx
343:
344: ; dx = s2 destination
345:
346:         call    StrLength         ; Find length of destination (s2)
347:         mov     dx, cx            ; Set dx to index end of string
348:         xchg   si, di            ; Exchange si and di
349:         call    StrLength         ; Find find length of source (s1)
350:         inc     cx                ; Plus one includes null terminator
351:         xchg   si, di            ; Restore si and di
352:         xor     bx, bx           ; Source index = 0
353:         call    MoveLeft         ; Copy source string to destination
354:
355:         pop     dx                ; Restore registers
356:         pop     cx
357:         pop     bx
358:         ret                     ; Return to caller
359: ENDP   StrConcat
360: %NEWPAGE
361: ;-----
362: ; StrCopy      Copy one string to another
363: ;-----
364: ; Input:
365: ;     si = address of source string (s1)
366: ;     di = address of destination string (s2)
367: ; Output:
368: ;     Chars in s1 copied to s2
369: ;     Note: s2 must be at least Length(s1)+1 bytes long
370: ; Registers:
371: ;     none
372: ;-----
373: PROC     StrCopy
374:         push    bx                ; Save modified registers
375:         push    cx
376:         push    dx
377:
378:         xchg   si, di            ; Swap si and di
379:         call    StrLength         ; Find length of source string (s1)
380:         inc     cx                ; Plus one includes null terminator
381:         xchg   si, di            ; Restore si and di
382:         xor     bx, bx           ; Source string index = 0
383:         xor     dx, dx           ; Destination string index = 0
384:         call    MoveLeft         ; Copy source to destination

```

```

385:
386:     pop    dx            ; Restore registers
387:     pop    cx
388:     pop    bx
389:     ret                ; Return to caller
390: ENDP   StrCopy
391: %NEWPAGE
392: ;-----
393: ; StrPos      Search for position of a substring in a string
394: ;-----
395: ; Input:
396: ;     si = address of substring to find
397: ;     di = address of target string to scan
398: ; Output:
399: ;     if zf = 1 then dx = index of substring
400: ;     if zf = 0 then substring was not found
401: ;     Note: dx is meaningless if zf = 0
402: ; Registers:
403: ;     dx
404: ;-----
405: PROC   StrPos
406:     push  ax            ; Save modified registers
407:     push  bx
408:     push  cx
409:     push  di
410:
411:     call  StrLength    ; Find length of target string
412:     mov   ax, cx        ; Save length(s2) in ax
413:     xchg  si, di       ; Swap si and di
414:     call  StrLength    ; Find length of substring
415:     mov   bx, cx        ; Save length(s1) in bx
416:     xchg  si, di       ; Restore si and di
417:     sub   ax, bx        ; ax = last possible index
418:     jb   @@20          ; Exit if len target < len substring
419:     mov   dx, 0ffffh   ; Initialize dx to -1
420: @@10:
421:     inc   dx            ; For i = 0 TO last possible index
422:     mov   cl, [byte bx + di] ; Save char at s[bx] in cl
423:     mov   [byte bx + di], ASCNull ; Replace char with null
424:     call  StrCompare   ; Compare si to altered di
425:     mov   [byte bx + di], cl ; Restore replaced char
426:     je   @@20          ; Jump if match found, dx=index, zf=1
427:     inc   di            ; Else advance target string index
428:     cmp   dx, ax        ; When equal, all positions checked
429:     jne  @@10          ; Continue search unless not found
430:
431:     xor   cx, cx        ; Substring not found. Reset zf = 0
432:     inc   cx            ; to indicate no match
433: @@20:
434:     pop   di            ; Restore registers
435:     pop   cx
436:     pop   bx
437:     pop   ax
438:     ret                ; Return to caller
439: ENDP   StrPos
440: %NEWPAGE

```

Listing 5.1. continued

```

441: ;-----
442: ; StrRemove      Remove substring from a string
443: ;-----
444: ; Input:
445: ;     si = address of substring to delete
446: ;     di = address of string to delete substring from
447: ; Output:
448: ;     if zf = 1 then substring removed
449: ;     if zf = 0 then substring was not found
450: ;     Note: string at si is not changed
451: ;     Note: if zf = 0 then string at di is not changed
452: ; Registers:
453: ;     none
454: ;-----
455: PROC      StrRemove
456:     push   cx           ; Save modified registers
457:     push   dx
458:
459:     call   StrPos       ; Find substring, setting dx=index
460:     jne   @@99         ; Exit if substring not found
461:     pushf                ; Save zf flag
462:     xchg  si, di       ; Swap si and di
463:     call   StrLength    ; Find length of substring
464:     xchg  si, di       ; Restore si and di
465:     call   StrDelete    ; Delete cx chars at di[dx]
466:     popf                ; Restore zf flag
467: @@99:
468:     pop    dx           ; Restore registers
469:     pop    cx
470:     ret                    ; Return to caller
471: ENDP      StrRemove
472:
473:     END                ; End of STRINGS.ASM module

```

Programming in Pieces

Before jumping into a description of the routines in the STRINGS module, you should know some of the ways that you can combine STRINGS with programs and with other object-code modules. Modules like STRINGS can declare subroutines, variables, and constants to be shared with programs and other modules. An object-code module is a self-contained package, assembled apart from other code, and then linked to a host program, creating the finished executable disk file.

Dividing large programs into modules is a great time saver. Instead of reassembling the identical code over and over, you can store that code in a separate module, assemble to disk, and then link with your program. When modifying existing programs, you have to reassemble only the modules that you modify. Modules also help simplify complex programs by letting

you concentrate on smaller and easier to digest chunks of code. In addition, you can store object-code modules in library files, making your favorite subroutines instantly available to new programs.

In the source-code text, a separate module differs only slightly from the text of a main program. Referring to Listing 5.1, you can see that the initial lines are the same as in previous listings (for example, see Listing 4.7) but do not include a `STACK` directive. Only the main program can declare a stack segment—separate modules never need to do this.

Another difference is that separate modules lack the steps in a main program to initialize data-segment registers and to return control to DOS when the program ends. Instead, as you can see, Listing 5.1 contains a series of procedures, marked by the `PROC` and `ENDP` directives. A final `END` directive ends the text but does not add an entry-point label to `END` as must be done in a main program file (for example, see line 52 in Listing 4.7). Only the main program can specify an entry point.

Public Policy

Lines 9-11 in `STRINGS` declare several symbols in `PUBLIC` directives. These symbols are the same names used as labels in `PROC` procedure headers. (For example, see line 73.) Every symbol that you want a module to export to the outside world must be declared in a `PUBLIC` directive as shown here. You can use individual `PUBLIC` directives to declare symbols one at a time or string them together with commas as in this example. Symbols can be the names of numeric constants declared with equal signs (`=`), variables, or code labels. Constants declared with `EQU` cannot be exported.

NOTE

In Ideal mode, `EQU` constants are treated during assembly as *text*, while equal sign (`=`) constants are treated as *values*. In MASM mode, some `EQU` constants are numeric and, therefore, can be exported. Other kinds of `EQU` constants must remain private. This does not mean that Ideal mode imposes additional limits on exporting symbols. It just means that, in Ideal mode, you always know which constants are exportable. In both modes, only the same types of numeric constants can be shared with the outside world.

All other symbols not declared `PUBLIC` (`ASCNU11` at line 55, for instance) are private and cannot be used by other programs. Private symbols may be repeated by modules and programs without conflicting with the symbols declared private in other modules. Only symbols in `PUBLIC` directives are visible outside of the module. Notice that the symbols in the `PUBLIC` directive have no data-type identifiers—nothing to indicate what the symbols are. As later examples demonstrate, this is the responsibility of the program that imports the symbols.

NOTE

Some programmers declare separate `PUBLIC` directives just above each `PROC` header. I prefer to collect all `PUBLIC` symbols into one place at the beginning of the file, where I can easily find and modify the list. Both methods are correct and have the same effects.

Assembling and Linking Separate Modules

Assembling separate modules is easy. Just type `tasm module` where *module* is the name of the text file to assemble. You do not have to specify the `.ASM` extension after the filename. To assemble the module for use with Turbo Debugger, use the command `tasm -zi module`, which adds extra information to the `.OBJ` file so that Turbo Debugger can locate variables and subroutines by name.

To assemble a program that uses the code in separate modules, use either of these same commands. You can assemble the main program and all its modules in any order, and none of the module's `.OBJ` files needs to be on disk during assembly of any other modules. After assembling all modules, you'll have a series of `.OBJ` files on disk. The next step is to link these separate pieces together to create the finished code. For example, if your main program is `THEMEAT.ASM` and your modules are `LETTUCE.ASM` and `MUSTARD.ASM`, you would first assemble each module:

```
tasm lettuce
tasm themeat
tasm mustard
```

You can perform these steps in any order. Or, if these are the only `.ASM` files in the current directory, you can use the simpler command `tasm *.ASM` to assemble all three files. After assembling, you'll have `THEMEAT.OBJ`, `LETTUCE.OBJ`, and `MUSTARD.OBJ` on disk. You then link these object-code files with the command:

```
tlink themeat lettuce mustard
```

The first name after `tlink` must refer to the main program. Subsequent names refer to the separate modules used in the program. Multiple module names may be listed in any order and are separated by spaces. (You can also use plus signs as in `tlink themeat+lettuce+mustard`.) The result of linking is a sandwich of all modules plus the main program in one finished code file, in this example, `THEMEAT.EXE`. The name of the result is the same as the name of the first object file after `TLINK` but with the extension changed to `.EXE`. To specify a different name, `SANDWICH.EXE` for instance, add a comma and the new name after the object-file list:

```
tlink themeat lettuce mustard, sandwich
```

A comma must separate the object-file list from the new .EXE filename. During linking, TLINK creates a map file containing a report of the symbols and their addresses in the finished code. The map file has the same name as the default .EXE file but ends in .MAP, unless you specify a different name. This assembles the object files (represented here as <obj-files>), and creates both SANDWICH.EXE and SANDWICH.MAP:

```
tlink <obj-files>, sandwich, sandwich
```

If you don't want a map file, use the /x option before the object-file list. This saves disk space and speeds linking a tiny bit by reducing TLINK's work load. Turbo Debugger does not require the map file, but some other debuggers and source-code utility products from other companies do. You may also want to save the map file as part of your program's documentation. This command specifies no map file:

```
tlink /x <obj-files>
```

The final option you can specify with TLINK is the name of one or more library files, which contain separately assembled object modules in one disk file. Put spaces between multiple library filenames. For example, if you have two libraries, BUTTER.LIB and BREAD.LIB, the complete linking command might be:

```
tlink <obj-files>,,,butter bread
```

You don't have to specify the .LIB extension. Notice the three commas after the object-file list. These commas tell Turbo Assembler to use the default names for the missing items. Without the commas, Turbo Linker can't know that BUTTER and BREAD are library files—it would mistake them for .OBJ files. You must add the commas to hold the places for optional items you don't specify. With square brackets representing optional items, the complete syntax for TLINK 6.0 is:

```
tlink [options] objfiles, exefile, mapfile, libfiles, deffile, resfiles
```

In this command, *objfiles* refers to assembled object code files; *exefile* is the name of the final output code file, *mapfile* lists public symbols and other information, *libfiles* refers to libraries such as MTA.LIB (provided on disk) that contain multiple object-code files, *deffile* is a linker definition file, and *resfiles* refers to resources combined into the finished code. The last two items, *deffile* and *resfiles*, are required only for Windows programs.

A String I/O Package

Although the STRINGS module can be used alone, another module is needed to display strings and to read new strings from the keyboard. This second module makes it easy to experiment with STRINGS and also serves as a useful module on its own. Assemble Listing 5.2, STRIO.ASM, and add the object code to your MTA.LIB library file with the commands:

```
tasm /zi strio
tlib /E mta --strio
```

For running host programs in Turbo Debugger, you must use the /zi option both here and when assembling STRINGS. To reduce code-file size, assemble with tasm strio and reinstall STRIO in the library. At the tlib command, ignore the probable warning that STRIO was not found in the library. You'll see this warning only the first time you add STRIO to MTA.LIB. At this point, you now have two modules in MTA.LIB: STRINGS and STRIO. To see a list of the symbols in the library file, enter:

```
tlib mta, con
```

Or, replace con with prn to send output to the printer. You can also store tlib's output in a disk file with a command such as tlib mta,temp.txt. Be careful—TLIB won't warn you before erasing an existing file of the same name.

Listing 5.2. STRIO.ASM.

```
1: %TITLE "String Input/Output Routines -- by Tom Swan"
2:
3:         IDEAL
4:
5:         MODEL    small
6:
7:
8: ;----- Equates
9:
10: BufSize      EQU    255           ; Maximum string size (<=255)
11: ASCnull      EQU    0             ; ASCII null
12: ASCcr        EQU    13           ; ASCII carriage return
13: ASClf        EQU    10           ; ASCII line feed
14:
15:
16: ;----- String buffer structure for DOS function 0Ah
17:
18: STRUC StrBuffer
19: maxlen       db BufSize           ; Maximum buffer length
20: strlen       db 0                 ; String length
21: chars        db BufSize DUP (?)   ; Buffer for StrRead
22: ENDS StrBuffer
23:
24:
25:         DATASEG
26:
27: buffer StrBuffer <>                ; Buffer variable for ReadStr
28:
29:
30:         CODESEG
31:
32: ;----- From: STRINGS.OBJ
33:
34:         EXTRN  StrLength:proc, StrCopy:proc
```

```

35:
36:     PUBLIC StrRead, StrWrite, StrWrite2, NewLine
37:
38: %NEWPAGE
39: ;-----
40: ; StrRead           Read string with editing keys
41: ;-----
42: ; Input:
43: ;     di = address of destination string
44: ;     cx = maximum string length EXCLUDING null terminator
45: ;     Note: if cx = 0, StrRead does nothing
46: ;     Note: actual variable must be cx+1 bytes long
47: ;     Note: string length is limited to 255 characters
48: ; Output:
49: ;     String copied from standard input into your buffer
50: ; Registers:
51: ;     none
52: ;-----
53: PROC   StrRead
54:     or     cx, cx           ; Is cx = 0?
55:     jz     @@99           ; If yes, jump to exit
56:
57:     push  ax               ; Save modified registers
58:     push  bx
59:     push  dx
60:     push  si
61:
62:     mov   [buffer.maxlen], cx ; Set maxlen byte
63:     mov   ah, 0ah          ; DOS Buffered-Input function
64:     mov   dx, offset buffer.maxlen ; Address struc with ds:dx
65:     int   21h             ; Call DOS to read string
66:     xor   bh, bh          ; Zero high byte of bx
67:     mov   bl, [buffer.strlen] ; bx = # chars in buffer
68:     mov   [bx+buffer.chars], ASCnull ; Change cr to null
69:     mov   si, offset buffer.chars ; Address buffer with si
70:     call  StrCopy         ; Copy chars to user string
71:
72:     pop   si               ; Restore registers
73:     pop   dx
74:     pop   bx
75:     pop   ax
76: @@99:
77:     ret                   ; Return to caller
78: ENDP   StrRead
79: %NEWPAGE
80: ;-----
81: ; StrWrite/StrWrite2 Write string to standard output
82: ;-----
83: ; Input:
84: ;     di = address of string (s)
85: ;     cx = number of chars to write (StrWrite2 only)
86: ; Output:
87: ;     string s copied to standard output
88: ;
89: ; Registers:
90: ;     cx (StrWrite only)

```

continues

Listing 5.2. continued

```

91: ;-----
92: PROC    StrWrite
93:         call    StrLength        ; Set cx=length of string
94:
95: PROC    StrWrite2                ; Alternate entry point
96:         push   ax                ; Save modified registers
97:         push   bx
98:         push   dx
99:
100:        mov    bx, 1              ; Standard output handle
101:        mov    dx, di             ; ds:dx address string
102:        mov    ah, 40h            ; DOS write to file or device
103:        int    21h                ; Call DOS (on ret ax=# chars written)
104:
105:        pop    dx                ; Restore registers
106:        pop    bx
107:        pop    ax
108:        ret                       ; Return to caller
109: ENDP    StrWrite2                ; End of alternate procedure
110: ENDP    StrWrite                ; End of normal procedure
111:
112: %NEWPAGE
113: ;-----
114: ; NewLine      Start new line on standard output file
115: ;-----
116: ; Input:
117: ;     none
118: ; Output:
119: ;     carriage return, line feed sent to standard output
120: ; Registers:
121: ;     ah, dl
122: ;-----
123: PROC    NewLine
124:        mov    ah, 2              ; DOS write-char routine
125:        mov    dl, ASCCr          ; Load carriage return into dl
126:        int    21h                ; Write carriage return
127:        mov    dl, ASCLf          ; Load line feed into dl
128:        int    21h                ; Write line feed
129:        ret                       ; Return to caller
130: ENDP    NewLine
131:
132:        END                       ; End of STRIO module

```

Procedures in STRIO

There are three procedures in the STRIO module, which many programs in this book use. The three routines are:

- StrRead—Read an ASCIIZ string
- StrWrite—Write an ASCIIZ string
- NewLine—Start a new output line

The first two procedures require strings in ASCIIZ form—the same form used by the STRINGS module. All three routines use the standard DOS input and output files—usually the keyboard and display. As future programs demonstrate, there are faster ways to display text on screen than `StrWrite`. But even so, this small module comes in handy for reading and writing string data.

Using the STRIO Module

The three procedures in `STRIO.ASM` (Listing 5.2) should be easy for you to understand. Except for a data structure at lines 18–22, you have already met most of the elements in this listing elsewhere. This section explains how to use `STRIO`'s routines in your own programs to read and write ASCIIZ strings to the standard input and output files, normally the keyboard (input) and display (output). (We'll return to this program again in Chapter 6, "Complex Data Structures," which explains complex data structures.)

StrRead (39–78)

Assign to `es:di` the address of any ASCIIZ variable, which can be from 1 to 255 characters long plus 1 byte for the null terminator. Normally, ASCIIZ strings can be just about any length. But, due to limitations of DOS, you can read strings up to a maximum of only 255 characters. Also set `c1` to the maximum number of characters you want people to be able to enter. If `c1` equals 0, `StrRead` does nothing. Here's how you might use `StrRead` to prompt for some data to be entered at the keyboard:

```

DATASEG
response db 81 dup (0) ; 80-character string + null
CODESEG
mov di, OFFSET response ; Address response with es:di
mov c1, 80 ; Allow 0 to 80 characters
call StrRead ; Read string

```

Notice that `c1` is set to 80 even though the string variable is 81 bytes long. This allows 1 byte for the null terminator at the end of the string. Don't forget this all important rule—you must leave room for `StrRead` to insert the string-terminator byte. `StrRead` calls DOS function 0Ah at line 65, which requires the string structure defined at lines 18–22 (further explained in Chapter 6).

StrWrite (80–110)

To pass an ASCIIZ string to the standard output (usually the display), call `StrWrite` with `es:di` addressing the string. If you already know the string length, you can assign the length value to `cx` and call `StrWrite2` instead—an example of a *nested procedure*. Notice how the procedure at lines 95–109 nests inside the outer procedure at lines 92–110. The difference

between the two procedures is that, after calling `StrWrite2`, `cx` is not changed. After calling `StrWrite`, `cx` equals the string length. The nested procedure defines an *alternate entry point* into the subroutine.

NOTE

You don't have to define alternate entry points as nested procedures—you can simply add a new label and call or jump to that address. Using nested procedures makes the intention of the program perfectly clear—always a good plan, even when other strategies are available.

A typical use for `StrWrite` is to display a program's welcome message:

```
cr EQU 13 ; ASCII carriage return
lf EQU 10 ; ASCII line feed
DATASEG
welcome db cr, lf, 'Welcome to Noware Land'
         db cr, lf, '(C) 1998 by Nobody, Inc.', cr, lf, lf, 0
CODESEG
mov ax, @data
mov ds, ax ; Initialize ds
mov es, ax ; Initialize es = ds
mov di, OFFSEET welcome ; Address string with di
call StrWrite ; Display string
```

There are several interesting points here that deserve a closer look. First, two equates assign the ASCII values of a carriage return and line feed to symbols `cr` and `lf`. In the data segment, a string variable is then created, adding `cr` and `lf` as needed. In assembly language, the flexible `db` operator lets you easily add control characters this way directly to strings. Also, because variables are stored consecutively in memory, only one string variable is actually here—despite the fact that the string is declared in two separate `db` directives. Only one null terminator is at the end of the second line; therefore, this is one string, not two. Notice also how the string ends with a carriage return and two line feeds. The first carriage return sends the cursor to the far left of the display. After that, successive line feeds send the cursor down (or scroll the display up) twice. There's no need to add another carriage return. The ability to handle such flexible data structures is one of assembly language's most welcome features.

In the code segment of this sample, the first three instructions initialize `ds` and `es` to address the program's data segment. Always perform these steps in programs that use the `STRIO` module (as well as other modules in this book). After this, a `mov` instruction assigns the address of string `welcome` to `di`. A single `call` to `StrWrite` then displays the two-line string.

The code for `StrWrite` in `STRIO` is fairly simple. Lines 102–103 call DOS function 40h with `cx` equal to the string length, `bx` equal to 1 (representing DOS's standard output file), and `ds:dx` equal to the string address. The other instructions save and restore modified registers (except for `cx` when calling the `StrWrite` entry point).

NewLine (113–130)

The final procedure in STRIO is `NewLine`. Call this procedure to start a new line on the display. The procedure works by passing carriage-return and line-feed control codes in register `d1` to DOS function 2, which writes single characters to the standard output. Note that the procedure changes `ah` and `d1`.

Linking Modules into a Program

The good news is: You now possess two useful packages to manipulate, read, and write ASCII strings—routines that other programs in this book use heavily and that you'll find many uses for in your own code. The bad news is: You have to enter one more program to demonstrate how to use routines in separate modules. For this purpose, assemble and link Listing 5.3, `ECHOSTR.ASM`, creating `ECHOSTR.EXE`, with the command:

```
tasm /zi echostr
tlink echostr,,mta
```

As described earlier, the three commas hold the places of missing items in the `tlink` command, telling Turbo Linker that `mta` is the name of a library file. Also, you need to use the `/zi` option only if you want to run `ECHOSTR` in Turbo Debugger. To run the program from DOS, just type `echostr`. Then, type any string of characters and press Enter. You should see the same string repeated below your typing—proof that the STRIO module is working. Admittedly, this is a very simple example. But, as you will soon see, there's much more that you can do with STRINGS and STRIO.

Listing 5.3. ECHOSTR.ASM.

```
1: %TITLE "String Read Test -- by Tom Swan"
2:
3:         IDEAL
4:
5:         MODEL    small
6:         STACK   256
7:
8: MaxLen  EQU     128      ; 128-character string
9: cr      EQU     13      ; ASCII carriage return
10: lf     EQU     10      ; ASCII line feed
11:
12:
13:         DATASEG
14:
15: exCode  db      0
16: welcome db      'Welcome to Echo-String', cr, lf
17:         db      'Type any string and press Enter', cr,lf,lf, 0
18: testString db    MaxLen DUP (0), 0      ; MaxLen chars + null
19:
20:
```

continues

Listing 5.3. continued

```

21:          CODESEG
22:
23: ;----- From STRIO.OBJ:
24:
25:          EXTRN  StrRead:proc, StrWrite:proc, NewLine:proc
26:
27: Start:
28:          mov    ax, @data                ; Initialize DS to address
29:          mov    ds, ax                  ; of data segment
30:          mov    es, ax                  ; Make ds=es
31:
32:          mov    di, offset welcome      ; Display welcome message
33:          call   StrWrite
34:
35:          mov    di, offset testString   ; di = address of testString
36:          mov    cx, MaxLen              ; cx = maximum len
37:          call   StrRead                 ; Read string from keyboard
38:          call   NewLine                 ; Start a new display line
39:          call   StrWrite                 ; Echo string to display
40:
41: Exit:
42:          mov    ah, 04Ch                ; DOS function: Exit program
43:          mov    al, [exCode]            ; Return exit code value
44:          int    21h                    ; Call DOS. Terminate program
45:
46:          END    Start                  ; End of program / entry point

```

New Features in ECHOSTR.ASM

The STRINGS and STRIO packages require `ds` and `es` to address the same data segment. Line 30 in ECHOSTR satisfies this requirement by assigning the same value to `es` as assigned to `ds` in the previous line. EXESHELL.ASM (Listing 2.3) contains this instruction so you don't forget this important step when needed.

Line 25 in ECHOSTR shows how to import symbols that are declared in another module's PUBLIC directives. The EXTRN directive tells Turbo Assembler that various symbols are *external* to this program and that the actual addresses and values for these items will be supplied later when the program and all its modules are linked together. There are several things to keep in mind when using EXTRN:

- Every symbol in an EXTRN directive must eventually be resolved to a like symbol declared in a PUBLIC directive in a module linked to the program. Otherwise, you'll receive an error from Turbo Linker.
- EXTRN directives must specify the *type* of the symbol. In line 25, all three symbols are type *proc*, which tells the assembler that these are subroutine labels and, therefore, can be used as targets in `call` and `jmp` instructions. You can also declare code labels

as near and far, forcing the assembler to generate either intersegment or intrasegment subroutine calls. (It's still your responsibility to ensure that the correct `ret` instructions are used in the external routines.)

- When declaring external variables, allowable types are: `byte`, `word`, `dword`, `fword`, `pword`, `dataptr`, `qword`, and `tbyte`, corresponding to the data directives in Table 5.3. You must insert `EXTRN` directives for variables in the proper data segment, usually just after `DATASEG`. If you accidentally declare external variables inside the `CODESEG`, the linker will be unable to calculate the correct addresses for your external data.
- External numeric equates are always type `abs` (for absolute value). A good place for these `EXTRN` symbols is before the `DATASEG` directive.
- Object-code modules can declare `EXTRN` directives, too. For example, see line 34 in `STRIO.ASM` (Listing 5.2), which imports two procedures from the `STRINGS` module. Any module can export its own symbols in `PUBLIC` directives and import external symbols from any other module in `EXTRN` directives.
- When multiple modules (including the main host program) refer to the same `EXTRN` symbols, only one copy of the object-code module containing those symbols is linked into the finished code file.
- You need to declare only the symbols your program uses. You don't have to declare all of the symbols that are declared `PUBLIC` in a module. Despite this, Turbo Linker always links entire modules into the finished code, even if you use only one or two procedures (or other declarations) in that module.
- To create a complete code file, you must link all modules containing the symbols that are declared in `EXTRN` directives among all the program's modules. Storing object code in library files makes linking easier by allowing Turbo Linker to pick out only the object-code modules it needs. The entire library is *not* linked into your code—only the necessary modules stored in the library.

A Simplified External Example

A few quick examples will help clarify the preceding details about exporting and importing equates, variables, and procedure labels. (You don't have to enter and run these samples, although you can if you want to.) Here's the object-code module:

```

IDEAL
MODEL    small
PUBLIC   Maximum
Maximum = 100h
DATASEG
PUBLIC   counter
counter db 0fh
CODESEG
PUBLIC   subroutine

```

```

PROC    subroutine
        ret
ENDP    subroutine
        END

```

After switching to Ideal mode and specifying the small memory model, the module declares numeric equate `Maximum` public. In the data segment, another symbol—the byte variable `counter`—is also declared public. In the code segment, a third symbol, `subroutine`, a procedure label, is exported. Notice that the `PUBLIC` directives are placed in sensible places. A host program can import these symbols this way:

```

        IDEAL
        MODEL    small
        STACK    256
EXTRN   Maximum:abs
        DATASEG
EXTRN   counter:byte
        CODESEG
EXTRN   Subroutine:proc
Start:  mov     ax, @data           ; Initialize ds to address
        mov     ds, ax           ; of data segment
        mov     ax, Maximum      ; Set ax = Maximum
        mov     cx, [counter]    ; Get value of counter
        mov     bx, OFFSET counter ; Get address of counter
        call    Subroutine       ; Call external subroutine
Exit:   mov     ax, 04C00h        ; DOS function: Exit program
        int     21h             ; Call DOS. Terminate program
        END     Start           ; End of program / entry point

```

Look carefully at the placement of the `EXTRN` directives, especially for `counter` and `Subroutine`. These symbols are placed in the data and code segments so the linker will be able to resolve their addresses correctly. The type of the numeric equate is `abs`. The type of the `db` variable is `byte`. If the variable had been declared in the other module with `dw`, the type would be `word`. The `Subroutine` label is given the type `proc`. In the main program code, these symbols are used exactly as though they were declared directly in the program. If you want to assemble and run the finished program in Turbo Debugger, assuming you name the module `MODULE.ASM` and the main program `MAIN.ASM`, use these commands:

```

tasm /zi module
tasm /zi main
tlink /v main module
td main

```

Exploring the Strings Module

Now that you know how to write, assemble, and link separate modules, you're ready to explore the 12 procedures in Listing 5.1, `STRINGS`. All the procedures in `STRINGS` operate on ASCII strings—sequences of characters ending in a zero byte. You can also use the two routines `MoveLeft` and `MoveRight` on unterminated byte strings. In the interests of

speed—and, therefore, in the spirit of blue-blooded assembly language programming—most routines in *STRINGS* do little error checking. For example, when copying one string to another, it's your responsibility to ensure that the destination is large enough to hold the copied characters.

The following sections describe each of the routines in *STRINGS*. Line numbers refer to those in Listing 5.1.

NOTE

The *STRING*'s and *STRIO* modules assume that segment registers *ds* and *es* address the same data segment in memory. Serious bugs are likely to occur if you fail to set *ds = es* before calling any of the routines in these modules.

MoveLeft (58–89)**MoveRight (91–121)**

These two routines move bytes in memory from one location to another. Other string routines call *MoveLeft* and *MoveRight* to copy strings, attach one string to another, and insert characters into a string. You can also use these routines to fill buffers and to copy blocks of memory from place to place.

Both *MoveLeft* and *MoveRight* use a repeated string instruction, *movsb* at lines 82 and 114. The other instructions save and restore register values and prepare *si*, *di*, and flag *df* for the memory-block move. Notice how the *jcxz* instruction at line 74 prevents accidentally moving 65,536 bytes if *cx* is 0, jumping in this event to local label *@@99:* at line 87. A similar instruction at line 102 jumps to line 119 for the same reason. (Remember, local labels extend only up or down to the next nonlocal label; therefore, *@@99:* can be reused without conflict at lines 193, 267, and 467.)

NOTE

When viewing a repeated string instruction such as *rep movsb* in Turbo Debugger, press F8 to execute the instruction to completion. Press F7 to execute one iteration at a time.

The comments to *MoveLeft* and *MoveRight* at lines 58–72 and 91–100 list required registers and explain the effects of calling each routine. *MoveRight* requires the same input parameters as *MoveLeft*. When using these or any other procedures in *STRINGS*, always be sure to check the “Registers” section in the procedure header, which lists any potentially modified registers. In this case, *MoveLeft* and *MoveRight* are friendly—they return all original register

values intact. This isn't true for all procedures. By the way, the `%NEWPAGE` directives that begin each procedure in the `STRINGS` listing cause form-feed control characters to be written to the listing file, if you create one with Turbo Assembler's `/1` command. This makes listings neater by starting new procedures at the tops of fresh pages.

Call `MoveLeft` with `si` addressing the source string and `di` addressing the *destination*—the place to where you want to copy bytes. Assign to `bx` and `dx` index values for copying bytes somewhere other than the start of the strings. For example, to copy a 20-byte variable `v1` to the middle of a 40-byte variable `v2`, you could write:

```

DATASEG
v1      db      '12345678901234567890', 0 ; 20-byte string
v2      db      40 dup (0)                ; 40-byte string
CODESEG
mov  si, OFFSET v1      ; Assign source address of v1
mov  di, OFFSET v2      ; Assign destination address
mov  bx, 0               ; Set source index (v1[0])
mov  dx, 10             ; Set destination index (v2[10])
mov  cx, 20             ; Specify the number of bytes to move
call MoveLeft           ; Move bytes from v1[0] to v2[10]

```

`MoveLeft` copies bytes from left (low addresses) to right (high addresses). When the source and destination addresses overlap—as they may, for example, when moving bytes inside the same string variable—the direction of the move can have important consequences. An example explains this action:

```

mov  [buffer], 0        ; Set first byte of buffer to 0
mov  si, OFFSET buffer  ; Address start of buffer with si
mov  di, si             ; Address same buffer with di
xor  bx, bx            ; Set source index to 0
mov  dx, 1             ; Set destination index to second byte
mov  cx, (LENGTH buffer) - 1 ; Set count = Length of buffer - 1
call MoveLeft          ; Fill buffer with 0s

```

The first `mov` sets the first byte in `buffer` to 0. Registers `si` and `di` are assigned the same offset address of this variable. After this, source index `bx` is set to 0 (the index position of the first byte in `buffer`), and `dx` is set to 1 (the index of the second byte in `buffer`). Then, using the `LENGTH` operator—which returns the number of bytes in a variable—`cx` is set to 1 less than the length of `buffer`. Calling `MoveLeft` with these parameters copies the byte at `buffer[0]` to `buffer[1]`, then from `buffer[1]` to `buffer[2]`, and so on, filling the entire buffer with the value originally at index 0.

NOTE

A better way to fill a buffer with a byte value is to use a repeated `stosb` or `stosw`. `MoveLeft` is fast, but not as fast as a single string instruction!

When the source and destination addresses overlap and you don't want to replicate the source bytes in the destination, you must begin the move at the opposite end of the variables. `MoveRight` accomplishes this by adding `cx-1` to `si` and `di` (see lines 109–112). Next, `std` prepares to decrement `si` and `di` automatically while the repeated string instruction at line 114 executes. This prevents the source bytes from shifting into the destination, which is especially useful for moving bytes to higher addresses in a variable—for example, to perform an insertion in a large text buffer. Here are a few more hints that will help you get the most from `MoveRight` and `MoveLeft`:

- When the source and destination addresses overlap, if the source is lower than the destination, call `MoveRight` to prevent accidentally replicating source data into the destination.
- When the source and destination addresses overlap, if the source is higher than the destination, call `MoveLeft` to prevent accidentally replicating source data into the destination.
- When the source and destination addresses do not overlap, always call `MoveLeft`. This routine runs a tiny bit faster because it does not have to adjust `si` and `di` by `cx-1`.

StrNull (123–136)

Call `StrNull` to erase the characters in a string addressed by `di`. `StrNull` operates by storing a zero byte at the start of the string (line 134). Examine the phrase in brackets, duplicated here for reference:

```
mov [byte ptr di], ASCNull
```

The `byte ptr` operators tell Turbo Assembler that `di` addresses an 8-bit byte. Replace `byte` with `word` if `di` addresses a 16-bit word. The `ptr` is optional, and you could revise this line to read:

```
mov [byte di], ASCNull
```

To use `StrNull`, assign the address of a string variable to `di` and call the procedure. For example, you might use `StrNull` to set the length of an uninitialized string variable to 0:

```
UDATASEG
string db 81 dup (?) ; Uninitialized 80-character string
CODESEG
mov di, OFFSET string ; Address string with di
call StrNull ; Set string Length to 0
```

Because a zero-length ASCII string has a null terminator as its first character, `StrNull` doesn't need to know the maximum string size and, therefore, works with any length string variables.

StrLength (138–162)

StrLength calculates how many characters are stored in an ASCIIZ string addressed by `di`. StrLength returns this value in `cx`, which can then be passed to other routines that need to know the length of a string. (Notice that line 146 tells you that `cx` is subject to change. If you are using `cx` for other purposes and need to call StrLength, you'll have to save `cx` somewhere—probably on the stack—and then restore the original value later.)

Suppose you want to jump to the end of the program if, after prompting for some input, the length of the string is 0. You could write:

```

DATASEG
string  db  'Sample user response string', 0
CODESEG
mov  di, OFFSET string  ; Address string with di
call StrLength          ; Set cx to string Length
or   cx, cx             ; Is cx = 0?
jz   Exit               ; Jump to Exit if cx = 0

```

StrLength demonstrates how to use the `scasb` string instruction, introduced in Chapter 4. Use `scasb` to scan byte strings for a specific value; use `scasw` to scan word strings. The value to search for must be in `al` for byte searches or in `ax` for word searches. Assign the starting address for the scan to `es:di` and set `cx` to the maximum number of bytes to scan. Both `scasb` and `scasw` compare the byte in `al` or the word in `ax` with the data at `es:di`, effectively performing a `cmp`. With these instructions, you can devise loops to search for byte and word values:

```

cld                ; Prepare to auto-increment di
mov  di, buffer    ; Address buffer with es:di
mov  cx, lenbuffer ; Set cx = Length of buffer
mov  al, searchval ; Set al = value to find
repne scasb       ; Repeat while bytes not equal
je   Match        ; Match found
jmp  NoMatch      ; Match not found

```

In this code, the `repne` prefix executes `scasb` repeatedly, while `al` and the byte at `es:di` are “not equal (ne),” decrementing `cx` and stopping if this makes `cx = 0`. After the scan, two jumps test whether the search ended at a matching byte, jumping to appropriate labels (not shown). Because `scas` sets the same flags as `cmp`, you can follow the scan with conditional jumps as shown here.

The effect of the repeated scan at line 155 in procedure StrLength is to scan an ASCIIZ string, stopping when the byte at `es:di` is 0 or when `cx` decrements to 0, thus preventing a runaway condition that might occur if you accidentally pass an uninitialized string to the procedure and if no zero bytes are in the data segment—unlikely, but possible.

Repeated-Loop Calculations

Lines 156–157 in `StrLength` uses an obscure technique to calculate the number of times that a repeated string operation executes. The method requires `cx` to be initialized to `0FFFFh` (-1 in two's complement notation) as done here at line 153. After the repeated scan (line 155), a simple logical operation calculates the number of times the previous scan had repeated. To understand how this works, first consider the classic method for calculating the repeated string instruction count:

```
mov  cx, -1      ; Initialize cx to -1
repnz scasb     ; Repeat while [di] <> al and cx <> 0
not  cx         ; Form one's complement of cx
```

The one's complement of `cx` equals the number of times the `repnz scasb` loop executed. Why this works is easier to fathom by thinking through the effect of a single iteration. Because `cx` initially equals -1 , if the `scasb` stops after one repetition, then `cx` will equal -2 , or `FFFE` hexadecimal. (The `repnz` prefix subtracts 1 from `cx` for each repetition of `scasb`.) The absolute value (two's complement) of -2 is, of course, 2 —which is 1 too many. You could subtract 1 from the absolute value to get the correct answer ($2 - 1 = 1$ iteration), but recalling from Chapter 3, “A Bit of Binary,” that the two's complement of a value equals the one's complement plus 1, you may as well just take the one's complement as the final result! By the way, this works for positive values, too. If `cx` equals `32,766` after the scan, then `32,769` loops had been executed. Work out in binary the one's complement of `32,766` (`7FFEh`) to prove to yourself that this is so.

For `StrLength`'s purposes, the classic method's result is 1 too many because the value counts the null terminator at the end of the string. For this reason, line 157 decrements `cx` to give the final answer.

StrUpper (164–199)

`StrUpper` converts lowercase letters in a string to uppercase without changing other nonalphanumeric characters. Assign the string address to `di` and call the procedure this way:

```
DATASEG
lc  db  'abcdefghijklmnopqrstuvwxyz', 0
CODESEG
mov  di, OFFSET lc      ; Address string with es:di
call StrUpper          ; Convert chars to uppercase
```

The procedure demonstrates two popular string instructions `lodsb` and `stosb`, introduced in Chapter 4, along with a new instruction, `loop` (see line 192). The `loop` instruction subtracts 1 from `cx` and, if `cx` is not yet 0, jumps to the specified target address. In `StrUpper`, the target address is the local label, `@@10:` at line 183. `Loop` effectively performs in one step the same job as these instructions:

```
dec  cx           ; cx <- cx - 1
jnz  Target      ; Jump to Target if cx <> 0
```

Two other variations of `loop` are `loopne/loopnz` and `loope/loopz`. The mnemonic pairs are just different names for the identical instructions for the same reasons that other instructions such as `repne/repnz` and `jnz/jne` have double names. `loopne` and `loopnz` also jump to a target label if, after decrementing `cx`, this register is not yet 0. At the same time, a test is made of `zf`, presumably set or cleared by a previous comparison. For example, to scan a buffer from back to front searching for a byte equal to `0FFh`, you might use code such as:

```

    mov cx, LENGTH buffer
    mov bx, OFFSET buffer + LENGTH buffer
@@20:
    dec bx
    cmp [BYTE bx], 0ffh
    loopne @@20
    je Match

```

Register `cx` is set to the maximum number of bytes to scan; `bx` is set to the address just past the end of the buffer. The three instructions after `@@20`: then decrement the index pointer `bx`, comparing each byte at this address with `0FFh`. The `loopne` instruction subtracts 1 from `cx` and jumps to `@@20`: only if `cx` is not 0 and if the `cmp` did not detect an `0FFh` byte. After the search is completed, a `je` instruction jumps to label `Match` (not shown) only if the `0FFh` value was found in the buffer. You can use `loope` similarly to locate bytes or words that don't match a certain value.

As you can see, `loop`, `loope`, and `loopne` are handy instructions for writing search loops. Returning to the `STRINGS` module, in `StrUpper`, after initializing `cx` to the string length, exiting immediately if the length is 0 (see lines 175-182), the instructions at lines 183-192 use `lodsb`, `stosb`, and `loop` to scan the string, examining each character with two `cmp` instructions. If a lowercase letter is found, line 189 adjusts the ASCII value to uppercase. Notice how the expression in `sub a1, 'a'-'A'` subtracts from `a1` the numeric difference between ASCII lowercase and uppercase letters. Characters in assembly language are just numbers and, as this demonstrates, you can use them directly in numeric expressions. (BASIC and Pascal programmers may find this a bit strange. C programmers are no doubt right at home.) Remember that Turbo Assembler evaluates this and other constant expressions during assembly, not at run time. You could write `sub a1, 32` to do the same thing, but then the purpose of the instruction would be less clear.

StrCompare (201-229)

Comparing two strings alphabetically is a surprisingly simple job, as you can see in the `StrCompare` procedure. To use `StrCompare`, assign the addresses of two strings to `si` and `di` and call the procedure. After that, use one of the unsigned conditional jump instructions `jb`, `jbe`, `je`, `ja`, or `jae` to test the result of the comparison. For example, to compare strings `s1` and `s2` and then jump to label `StringsLess` if `s1` is alphabetically less than `s2`, you can write:

```

DATASEG
s1 db 80 dup (0) ; ASCIIZ string variables, presumably
s2 db 40 dup (0) ; assigned characters elsewhere
CODESEG
mov si, OFFSET s1 ; Address first string with si
mov di, OFFSET s2 ; Address second string with di
call StrCompare ; Compare s1 and s2
jb StringsLess ; Jump if s1 < s2
jg StringsGreater ; Jump if s1 > s2
; If here, s1 = s2!

```

You can use multiple jumps as shown here without calling `StrCompare` a second time. The string variables do not have to be the same size, and the string lengths can be 0. Both strings *must* end with 0 bytes, or `StrCompare` will start behaving strangely.

The code works by using `lodsb` and `scasb` at lines 219–220, loading a single character into `al` and comparing the ASCII value with the character at `[es:di]`. These two instructions also advance `si` and `di` by 1 (because of the previous `cld` instruction at line 217). The `jne` at line 221 exits the loop if the comparison fails. Obviously, if any characters are different, so are the strings, and the alphabetic result is known at the first such difference found. The `or` instruction at line 222 checks whether `al` is 0, indicating that the end of the first string at `ds:si` was found before reaching the end of the second string at `es:di`. If the end is not found, the `jne` at line 223 continues the comparison; otherwise, the loop ends.

You might be wondering what happens if the second string at `es:di` is shorter than the first at `ds:si`. In this event, assuming that all characters are equal up to the end of the shorter string, the `scasb` at line 220 compares a character from the first string at `ds:si` with the null terminator at the end of the second string at `es:di`. Obviously, this comparison fails; therefore, the result indicates that the longer string is alphabetically greater than the shorter. In other words, this comparison actually involves the null terminator, which is not a character in the string. However, the result is correct.

It may take a little effort to understand all this by simply reading the text and program. For a better picture of how `StrCompare` works, try running a small test program in Turbo Debugger and compare different strings. Watch in particular the `cf` and `zf` flags during the loop at lines 218–223.

StrDelete (231–273)

`StrDelete` deletes one or more characters starting at any position in a string and prevents you from deleting more characters than exist in the string, making it easy to perform jobs such as stripping the extension from the end of a filename or limiting responses to a certain number of characters. Assign to `di` the address of any ASCIIZ string variable, set `dx` to the index of the first character to delete (starting with 0 for the first character in the string), and assign to `cx` the number of characters to delete. For example, this deletes the phrase “and tigers” plus one space from a string:

```

DATASEG
string      db 'Lions and tigers and bears, oh my!', 0
CODESEG
mov  di, OFFSET string      ; Address string with es:di
mov  dx, 6                  ; Index to the "a" in and
mov  cx, 11                 ; Number of chars in "and tigers "
call StrDelete              ; Delete 11 chars at string[6]

```

NOTE

Although `StrDelete` prevents deleting more characters than exist in the string, `dx` must address a character in the string or point to the null terminator. In other words, `dx` must be less than or equal to the string length. Ignoring this rule might damage other variables and code in memory.

`StrDelete` works in two stages. Lines 259–261 handle the condition where you try to delete more characters than are in the string. In this case, the `mov` at line 260 inserts a null at the end of the new string and exits. Lines 263–266 delete characters by calling `MoveLeft` with both `si` and `di` addressing the same string. This moves the end of the string (including the null terminator) over top of the deleted characters. Notice the `short` operator (line 261) added to the `jmp` target address, telling Turbo Assembler that label `@099:` is no more than about 127 bytes distant. This helps the assembler generate a more efficient form of `jmp` than is required to jump farther away.

StrInsert (275–325)

Call `StrInsert` to insert characters from one string into another at any position. Assign to `si` the address of the source string (the one to insert into the other) and to `di` the address of the destination string (the one to receive the insertion). Assign to `dx` the index into the destination string where you want to begin the insertion. Remember that the first character is at index 0. The source string is not changed. This example inserts the string 'tab-A' into another string:

```

DATASEG
destination db 'Insert into slot-B          ', 0
source      db 'tab-A ', 0
CODESEG
mov  si, OFFSET source      ; Address source string with ds:si
mov  di, OFFSET destination ; Address destination with es:di
mov  dx, 7                  ; dx = index of "I" in destination
call StrInsert              ; Insert source into destination

```

NOTE

The destination string must be large enough to hold the inserted source string to prevent overwriting other variables and code in memory. It's up to you to prevent this condition when using `StrInsert`.

By this time, you should be able to understand the instructions for `StrInsert` from the comments in the listing. Hint: The call to `MoveRight` at line 313 punches a hole in the destination string just large enough to hold the insertion. Then the call to `MoveLeft` at line 319 copies the source-string characters into the hole. The other instructions initialize registers to prepare for these two block moves.

StrConcat (327–359)

`StrConcat` concatenates (joins) one string to another. The destination string at `es:di` must be large enough to hold the characters it now has plus the characters from the source string at `ds:si`. The source string is not changed. The following changes “This is” to “This is the end!”:

```
DATASEG
source      db  'the end!', 0
destination db  'This is          ', 0
CODESEG
mov si, OFFSET source      ; Address source with ds:si
mov di, OFFSET destination ; Address destination with es:di
call StrConcat             ; Attach source to destination
```

`StrConcat` calls `StrLength` at lines 346 and 349, once to find the end of the destination string and again to find the length of the source string. Notice how the `xchg` instructions at 348 and 351 temporarily swap `si` and `di` for these subroutine calls. After these steps, a call to `MoveLeft` at line 353 performs the attachment.

StrCopy (361–390)

`StrCopy` copies one string variable to another, which must be at least as long as the length of the original string plus 1 byte for the null terminator. The procedure is easy to use. Just assign the address of the source string to `si` and the destination to `di`. Then call `StrCopy`. Any characters in the destination string are subject to permanent erasure. For example, to copy the characters in one string to an uninitialized string variable, you could write:

```
DATASEG
s1      db  'Original string', 0
s2      db  80 dup (?) ; Uninitialized string variable
CODESEG
mov  si, OFFSET s1      ; Address source string with si
mov  di, OFFSET s2      ; Address destination string with di
call StrCopy            ; Copy string s1 and s2
```

The code to `StrCopy` isn't difficult to understand. An `xchg` instruction at line 378 swaps `si` and `di` so that `StrLength`, which uses `di`, can return the length of the source string. A second `xchg` (line 381) then restores the original register values. The other instructions in the procedure prepare registers for the call to `MoveLeft`, which performs the actual copy, moving the bytes of `s1` and `s2`.

StrPos (392–439)

StrPos is the most complex in the STRINGS module, although the individual instructions should all be familiar to you. Call StrPos to determine if and when a substring at `ds:si` exists inside a target string at `es:di`. After StrPos returns, if `zf` equals 1, then `dx` equals the index in the target string where the substring begins. If `zf` is 0, then the substring was not found in the target and the value in `dx` is meaningless. An example shows how to use StrPos to determine if the extension `.ASM` is in a file-name string:

```

DATASEG
extension    db  '.ASM', 0
filename     db  'MYTEST.ASM', 0
CODESEG
mov  si, OFFSET extension    ; Address substring with ds:si
mov  di, OFFSET filename    ; Address target string with es:di
call StrPos                  ; Search for substring in target
jz   foundExtension         ; Jump if substring found at dx
jmp  notfound               ; Jump if substring not found

```

After the subroutine checks that the substring length is less than or equal to the target string's length—otherwise, there's no sense continuing the search—lines 421–429 call StrCompare repeatedly until finding the substring or reaching the end of the target. The `mov` instructions at lines 422, 423, and 425 temporarily replace characters in the target with nulls, using the powerful base-indexed addressing mode, indexing the string at `bx` with register `di`. Repeating this operation and advancing a character at a time in the target eventually examines all possible positions where the substring might be located.

StrRemove (441–471)

Calling three other subroutines in the STRINGS module, StrRemove is handy for removing substrings from strings. It's simple to use, too. Assign to `ds:si` the address of the substring to delete. Assign to `es:di` the address of a target string. Then call StrRemove. If the substring is found in the target, the characters are removed; otherwise, no changes to the target are made. The substring is never changed. As in StrPos, the `zf` flag indicates the result of the removal: 1 if the substring was found and removed or 0 if not. Here's an example that deletes an area code from a phone number string:

```

DATASEG
phoneNumber  db  '(800)-555-1212', 0 ; Target string
areaCode     db  '(800)-', 0         ; String to delete
CODESEG
mov  si, OFFSET areaCode    ; Address substring to delete
mov  di, OFFSET phoneNumber ; Address target string
call StrRemove              ; Delete substring from target

```

Of interest in `StrRemove` are the `pushf` and `popf` instructions at lines 461 and 466, which save and restore the flag registers on the stack. This allows the procedure to return the `zf` flag result of the call to `StrPos` at line 459—necessary because the calls to `StrLength` and `StrDelete` change the flags.

Summary

All references to data take one of three forms: immediate, register, and memory. Immediate data is stored directly in machine-code instructions. Register data refers to values held in registers such as `ax` and `ch`. Memory references allow five variations: direct, register-indirect, base, indexed, and base-indexed. Despite the many different addressing methods available, the goal of all memory-addressing modes is to help the processor to form the effective address, a 16-bit unsigned offset from the start of a memory segment addressed by one of the four segment registers.

Expressions are reduced during assembly to constant values, which programs can use. Unlike a high-level language's expressions, expressions in assembly language are not evaluated at run time. Expressions can employ a variety of operators to combine labels, addresses, and other values in many different ways.

Simple variables are created by reserving space in a data segment with directives such as `db` and `dw`. The `DUP` operator can be added to these directives to reserve blocks of space. Initialized data is stored in the program's code file on disk. Uninitialized data is allocated at run time and is not preset to any specific values. The `db` directive can be used to allocate string variables delimited by single or double quotes.

The scope of local labels extends only to the next nonlocal label above or below. A local label is similar to a global label but begins with the symbol `@@`. Local labels help conserve memory by letting the assembler reuse RAM for other local labels. They also reduce the need to think up new label names for temporary use.

Modular programming divides large jobs into easy-to-manage pieces. Individual modules are assembled separately and then linked to a host program to create the finished code. Modules can export code, numeric constants, and variable labels in `PUBLIC` directives for other modules and programs to share. Programs and modules import symbols from other modules in `EXTRN` directives. The `TLIB` utility program stores object-code modules in library files, which can simplify linking multiple modules.

Exercises

- 5.1. Give examples of instructions that use immediate, register, and memory data.
- 5.2. Give examples of instructions that use each of the five memory-addressing modes.
- 5.3. Construct a data segment with byte, word, string, and one 1,024-byte buffer variables. Put the buffer into the uninitialized data-segment area.
- 5.4. Write a subroutine to initialize your buffer in Exercise 5.3 to contain sequential byte values ranging from 0 to 255.
- 5.5. Insert your subroutine from Exercise 5.4 into an object-code module. Then write a host program to call your subroutine. What steps are required to assemble and link your module and program?
- 5.6. What are some of the advantages of storing object-code modules in library files?
- 5.7. What does a `PUBLIC` directive do? What does `EXTRN` do?
- 5.8. To which local label does the following `jmp` refer?

```

@@40:
    inc ax
Repeat:
    jmp @@40
    cmp ax, 0
    jl Repeat
    lodsb
    je @@Exit
@@40:
    xor cx, cx
@@Exit:
    mov ax, 04Ch
    int 21h

```

- 5.9. Which of the following equates can be exported in a `PUBLIC` directive? What `EXTRN` directive is needed to import these symbols into a program?

```

IDEAL
MaxCount = 1000
cr EQU 13
lf EQU 10
YesAnswer = 'Y'
MaxSize EQU 4
BufferSize = MaxCount * MaxSize

```

- 5.10. Show three ways to declare a 20-character string variable.
- 5.11. Suppose you have the modules `GETDATA`, `PRINTER`, `READTEXT`, and the library file `MTA.LIB`. What instructions do you need to use to assemble and link a main program that uses the three modules plus the `STRIO` and `STRINGS` modules in the library?

- 5.12. What TLIB commands can you use to install the three modules in Exercise 5.11?
- 5.13. Suppose there is a byte variable named `Flag` stored in the code segment. What instruction or instructions do you need to use to load this byte into register `dh`?
- 5.14. Declare the following string using a `db` directive:
"This 'string' can't have 'too' many quotes," she said.

Projects

- 5.1. Write improved versions of the `MoveLeft` and `MoveRight` procedures in the `STRINGS` module by moving 16-bit words at a time with `movsw` when the `cx` byte count is even.
- 5.2. Write a series of test procedures to put the `STRINGS` and `STRIO` modules through their paces.
- 5.3. Rewrite `StrConcat` so that it calls `StrInsert` instead of `MoveLeft`. Verify that your procedure operates identically to the original.
- 5.4. Write a module to send `ASCIIZ` strings to the printer.
- 5.5. Write a program to use your printer module from Project 5.4 to initialize various print options on your printer.
- 5.6. [Advanced] Write a new `STRINGS` module to operate on byte-length strings. A byte-length string stores the length of the string in the first byte. The second and subsequent bytes stores the characters of the string. There is no null terminator, and string lengths are limited to 255 characters. Your `STRINGS` module should use the same procedure names as the `ASIIZ STRINGS` module in this chapter.

6

CHAPTER

Complex Data Structures

- Structures, 198
- More about Numeric Variables, 204
- Arrays in Assembly Language, 206
- Unions and Records, 213
- Efficient Logical Operations, 220
- Using Predefined Equates, 223
- Running VERSION, 224
- Converting Numbers and Strings, 225
- Programming a Number Base Converter, 240
- Summary, 243
- Exercises, 244
- Projects, 245

Structures

A structure is a named variable that contains other variables, called *fields*. The keyword `STRUC` begins the structure, followed on the same line by any name you want, for example, `MyStruct`. A matching keyword `ENDS` follows the last field in the structure. You can attach a copy of the structure's name after `ENDS` or leave the name out—similar to the way you can repeat a procedure name after `ENDP`. For example, this structure contains three fields representing a date:

```
STRUC    Date
  day    db    1          ; Day field--default value = 1
  month  db    ?         ; Month field--no default value
  year   dw    1991      ; Year field--default value = 1991
ENDS     Date          ; "Date" is optional here
```

You can insert fields of any type inside a structure, using the same methods that you use to declare plain variables. This example has three fields: `day`, `month`, and `year`. The first two fields are single bytes, with the first of these values initialized to 1. The second byte field is uninitialized. The third field is a word, initialized to 1991. The indentation of each field is purely for show. When defining structures such as this, remember these important points:

- A structure is not a variable. A structure is a schematic for a variable.
- Structures may be declared anywhere. The `STRUC` directive does not have to be placed in the program's data segment, although it certainly can be.
- A structure tells Turbo Assembler about the design of variables that you plan to declare later on or that already exist elsewhere in memory.
- Even though you use directives such as `db` and `dw` to define the types of a structure's fields, the structure does not reserve space in the data segment or cause any bytes to be written to the finished program.

Declaring Structured Variables

To use a structure design, you must reserve space in memory for the structure's fields. The result is a variable that has the design of the structure. Start each such variable declaration with a label, followed by the structure name, and ending with a list of default values in angle brackets `<>`. Leave the brackets empty to use the defaults (if any) defined earlier in the structure definition. Returning to the example `Date` structure again, the program's data segment might declare a `Date` variable like this:

```
DATASEG
birthDay    Date    <>          ; 1-0-1991
```

A label `birthDay` starts the variable declaration. Next comes the structure name `Date` at the same place you would normally use simple directives like `dw`. The empty angle brackets cause this date's fields to assume the default values declared in the structure. Uninitialized default field values—as in the `month` field here—are set to 0 unless all fields in the structure are uninitialized, and the variable is declared in the program's uninitialized data segment area.

In that case, the actual field values are undefined. Here are a few more examples:

```

DATASEG
today      Date      <5,10>      ; 5-10-1991
dayInDayOut Date     <11,12,1912> ; 11-12-1912
monthOfSundays Date   <,8,>      ; 1-8-1991

```

The today date variable replaces the first two default values—day and month—with 5 and 10. The missing third field value assumes the default from the structure design, here 1991. The second variable dayInDayOut replaces all three default values. The third variable monthOfSundays specifies a new month value while using the defaults for others, here changing month to 8. The first comma is needed to “get to” the second structure field. The second comma is not needed, and you could also write:

```
monthOfSundays Date    <,8>
```

A Structured Demo

A good way to learn more about structures is to examine a few sample structured variables with Turbo Debugger using Listing 6.1., STRUC.ASM. Refer to the numbered experiments following the listing after you assemble, link, and load the program into Turbo Debugger with the commands:

```

tasm /zi struc
tlink /v struc
td struc

```

Listing 6.1. STRUC.ASM.

```

1: %TITLE "TD Structure Demo -- by Tom Swan"
2:
3:      IDEAL
4:
5:      MODEL    small
6:      STACK    256
7:
8: STRUC  Date
9: day    db      1      ; Day--default value = 1
10: month db      ?      ; Month--no default value
11: year   dw      1991   ; Year--default value = 1991
12: ENDS   Date
13:
14: STRUC  CityState
15: city   db      '#####', 0      ; 20 or so chars
16: state  db      '##', 0          ; 2 chars
17: ENDS   CityState
18:
19:
20:      DATASEG
21:
22: exCode db      0
23:

```

continues

Listing 6.1. continued

```

24: today          Date          <>
25: birthDay      Date          <8,8,1988>
26: earthDay      Date          <1,1,2001>
27: newYear       Date          <,,1990>
28:
29: address        CityState    <>
30: glitterTown   CityState    <'Hollywood','CA'>
31: pennState     CityState    <'Pennstate','PA'>
32: hotSpot       CityState    <'Brownsville','TX'>
33: defaultState  CityState    <,'NH'>
34: defaultCity   CityState    <'New York City'>
35:
36:
37:                CODESEG
38:
39: Start:
40:     mov     ax, @data          ; Initialize DS to address
41:     mov     ds, ax            ; of data segment
42:
43: ; Note: run in Turbo Debugger--program doesn't do anything
44:
45: Exit:
46:     mov     ah, 04Ch           ; DOS function: Exit program
47:     mov     al, [exCode]       ; Return exit code value
48:     int     21h               ; Call DOS. Terminate program
49:
50:     END     Start             ; End of program / entry point

```

Running the STRUC Demo

You should have assembled STRUC and loaded the code into Turbo Debugger. Follow these suggested experiments to see how structured variables are stored in memory:

1. Press the Alt-V and V keys to select the View:Variables command. A window will pop into view, listing all the program's variables by name.
2. Press Tab to move the selection bar into the variable list, and then press the down arrow key to move the bar to "today." Notice the field values listed in braces to the right of the field names, giving you a quick glance of the data stored in the structured variables.
3. Press Ctrl-I to inspect the today variable. (You can also press F5 at this point to zoom the small window to full screen for a less constricted view.) Turbo Debugger lists each field on a separate line, using the names from the STRUC definition and showing you the actual values stored in memory. Because db can reserve space for both ASCII characters and bytes, the debugger shows these values both ways. Just ignore the characters for noncharacter byte fields. Integer values are shown in decimal and hexadecimal in parentheses.
4. Press Alt-F3 or Esc to close the inspection window. Move the selector bar down to the next variable (birthDay) and press Enter—a shorthand method to display an

inspection window. Compare the listed field values with those in the program at line 25. Press Alt-F3 or Esc and repeat these same steps for the remaining two dates at lines 26-27.

5. Lines 14-17 declare another structure `cityState`, with two string fields `city` and `state`. So that you can see the default values in Turbo Debugger, these strings are preinitialized to hatch marks. Normally, you'd initialize string values with less obtrusive symbols such as blanks or nulls. Starting again from the Variables window, move the selector bar to `address` and press Enter.
6. The two default fields are now displayed in the inspection window. The bottom of this window tells you the type and size of the structure and individual fields. Use the cursor keys to move the selector bar to one field (watch how the bottom line changes) and press Enter again. This opens up a new inspection window, allowing you to view the individual bytes in a field variable. Move the selector bar down to any single byte and press Enter one more time to open yet another inspection window, this time showing the address of an individual byte. Being able to step down into the byte values of a structured variable is one of Turbo Debugger's best features for assembly language programming, where finding data structures in memory can sometimes be extremely frustrating.
7. Press Esc several times until only the Variables window is again active (with double-line borders). Move the selector bar down to the next variable value `pennState`, and press Enter. Zoom to full screen with F5. Compare the displayed strings with the defaults at line 31. Notice that only the leading portion of the string field is replaced by the text in the angle brackets. The rest of the string is *padded* (filled) with the default characters from the `STRUCT` definition.
8. Lines 15 and 16 declare this structure's fields as ASCII strings, ending in null characters. But, on your display, the nulls appear to be missing. The reason for this discrepancy is that Turbo Debugger displays only the initial field value. To prove that the nulls are still where they should be, move the selector bar to `city` and press Enter. Then press the PgDn key until the bar rests on the final byte of this field (at line 19). Press Enter again and jot down the address (6C89:0060 for me). Press Esc twice, then select the `state` field. Press Enter. The address on my screen is 6C89:0062—indicating that there is an invisible byte at 6C89:0061. We've found the null!
9. To see the nulls in the string variables, press Esc several times to return to the Variables window. Press Alt-V and D to select the View:Dump command. Press Ctrl-G and enter the string address from step 8—6C89h:0060h for me. You *must* type the small *h* letters after the segment and offset address values. Press F5 to zoom. You are now looking at the structured variable values as stored in the program's data segment. Try to pick out the nulls, which separate the individual string fields.

10. There's no need to run this program—it doesn't do anything beyond showing you how structures are assembled. When you're done experimenting, press Alt-X to return to DOS.

As you can see from these notes, string fields in structures are fixed-length items. The hatch marks (#) in the default values at lines 15-16 are replaced by new values assigned in the angle brackets at lines 29-34. Turbo Assembler in Ideal mode fills the rest of the string with the default characters in the structure definition. (In MASM mode, any remaining characters are magically changed to spaces—even if this isn't what you want. Ideal-mode structures are much easier to use.) In Turbo Debugger, you can normally see only the first of a list of values declared in `db` and `dw` directives. To see each value, you could modify the `CityState` structure definition at lines 14-17, placing each field value on separate lines:

```
STRUC  CityState
city   db      '#####'
cnull  db      0
state  db      '##'
snull  db      0
ENDS   CityState
```

Because of the additional fields that now reserve bytes for the string null terminators, you also have to modify the variable declarations at lines 29-34, adding new values for each field. If you don't do this, you'll receive an "override" error during assembly, which happens when you try to override a default value such as a single byte with a multiple-byte string. Change lines 29-34 as follows, reassemble, and inspect the new variables with Turbo Debugger:

```
address      CityState      <>
glitterTown  CityState      <'Hollywood',0,'CA',0>
pennState    CityState      <'Pennstate',0,'PA',0>
hotSpot      CityState      <'Brownsville',0,'TX',0>
defaultState CityState      <,'NH'>
defaultCity  CityState      <'New York City'>
```

Using Structured Variables

Using the fields in a structured variable is only a little more difficult than using simple variables, as explained in Chapter 5. All of the same addressing modes are available. Because field names are contained by the structure definition, to refer to an individual field, you must write both the structure and the field names, separating the two with a period. Refer back to Listing 6.1. To assign a new value to the `day` field in `today`, you can assign an immediate value to a field in memory with:

```
mov [today.day], 5      ; Change day to 5
```

You can also load field values into registers as in this instruction, which reads the `year` into `ax`:

```
mov ax, [today.year]   ; Get year into ax
```

Other variations are possible. You can add, subtract, read, write, and logically combine fields and registers. Remember that in all cases, you have to give both the structure and variable names so the assembler can generate the correct address to your fields. Here are a few more examples:

```
inc [earthDay.day]      ; Add 1 to day field
add [newYear.year], cx ; Add cx to year field
cmp [today.month], 8   ; Does month = 8?
```

NOTE

In Turbo Assembler's Ideal mode, field names are local and unique to the structure in which the fields are defined. This means you can create multiple `STRUC` definitions with the same field names. For example, you might have two different structures each of which contains `day`, `month`, and `year` fields. You can't do the same in the more restrictive `MASM` mode, where all field names are global—meaning that one name can appear in only one structure definition throughout a program. For this reason, in `MASM` mode, you can't have two structures such as `Customer` and `Personal` with `Name` fields—you instead have to invent unique field names such as `Cname` and `Pname`. In Ideal mode, structures are much easier to use, although, because field names might be nonunique, you must write both the structure and field names separated by periods for all references.

STRIO Structures

In Chapter 5, I promised to explain the `StrBuffer` structure at lines 18-22 in `STRIO.ASM`, Listing 5.2. For reference, that data structure is repeated here:

```
BufSize EQU 255 ; Maximum string size
STRUC StrBuffer
  maxLen db BufSize ; Maximum buffer Length
  strlen db 0 ; String Length
  chars db BufSize DUP (?) ; Buffer for StrRead
ENDS strBuffer
```

`BufSize` is an equate equal to 255, the maximum-length string that DOS can read. The `StrBuffer` structure uses this value to declare three fields in the form required by DOS function 0Ah that reads strings from the standard input file (usually the keyboard). `StrRead` calls this routine to let you enter strings into variables. (See lines 39-78 in Listing 5.2.) This raw input is then converted to ASCIIZ format for use with routines in `STRINGS`, `STRIO`, and other modules in this book.

Line 27 in Listing 5.2 declares a variable buffer of the `StrBuffer` structure, using the default values in the structure definition. `StrRead` passes the address of this variable to DOS, which handles all the keyboard-processing details, limiting the result to the maximum length specified in field `maxLen`, storing the actual string length in field `strlen`, and inserting characters (if any) into field `chars`.

NOTE

Because `StrRead` calls DOS for input, you can edit your typing with the same function keys you are accustomed to using at the DOS prompt.

When you are done typing, pressing Enter causes DOS to set field `strLen` to the number of characters you typed. DOS also adds an ASCII carriage return to the end of the string. Because this is the wrong terminator for the ASCIIZ format, lines 66-68 in `StrRead` replace the carriage return with an ASCII null before copying the string to the program's variable (lines 69-70).

Notice how the program refers to string fields at lines 62, 64, 67, 68, and 69 using both direct- and base-addressing modes. In each case, the structure name is followed by a period and a field name. Line 62 stores the value of `c1` into the `maxLen` field of `buffer`. Line 64 shows how to find the offset address of a specific field `maxLen`. Line 68 adds the value of register `bx` to the start of the `chars` field, locating the address of the carriage return stored in `chars`.

More About Numeric Variables

In assembly language programs, you can represent values in hexadecimal, binary, or decimal. But, because the three number systems share the same digit symbols, you have to tell the assembler which number system you mean. To the end of your numbers, add a *b* for binary and an *h* for hexadecimal. Add nothing or *d* for decimal, the usual default for all numbers. For example, these variables represent the same values in the three number bases:

```
v1  dw  0100111101011100b  ; Binary
v2  dw  04F5Ch              ; Hexadecimal
v3  dw  20316                ; Decimal (default)
v4  dw  20316d              ; Decimal
```

Notice that the hex value (04F5Ch) begins with a leading 0. This 0 is required only if the first digit is A-F as in the value 0FACEh. Even so, it's not a bad idea to include the 0 anyway—if only to be consistent. Hex values must begin with *decimal* digits because the assembler can't know whether FACEh is a label or a value. As a result, you must observe one strict rule when writing numeric values: The first digit of all values in any base must be a digit—0 or 1 for binary; 0 to 9 for decimal and hex. Adding a leading 0 to hex value satisfies this rule.

Using RADIX

Unless you end a number with *b* or *h*, Turbo Assembler assumes the value is decimal. To change this default behavior, use the `RADIX` directive. (*Radix* means “number base.”) For example, to make hexadecimal the default radix, use the command:

For most purposes, it's probably best to stick with the assembler's default decimal radix and use *h* and *b* to specify your hexadecimal and binary values. If you forget to change the `RADIX` to hexadecimal in a new program, you could easily mistake 100 for 256 decimal. There's just no mistaking 0100h as a hexadecimal value.

NOTE

The value following `RADIX` is always expressed in decimal and must be 2 (binary), 8 (octal), 10 (decimal), or 16 (hexadecimal) regardless of the current radix in effect. Also, if you change the default radix, remember to end every decimal value with *d*.

Signed and Unsigned Integers

When declaring values with `db` and `dw`, be aware of the differences between signed and unsigned values, as explained in Chapter 3. Unlike high-level languages, assembly language enforces no limits on signed number ranges; therefore, as long as the value you specify fits within the space you allocate, the assembler accepts your every wish and command. For example, you can write:

```
v1 dw 32768      ; 08000h
v2 dw -32768    ; 08000h !
v3 dw -1        ; 0FFFFh
v4 dw 65535     ; 0FFFFh !
```

When Turbo Assembler stores these values in memory, the results may not be what you expect. Variable `v1` is stored as the unsigned value 32,768 or 08000h. (Note: Commas are used in numbers here to make them easier to read. You can't add commas to numbers in programs.) Notice that this value is identical to the signed value -32,768—at least it is in the world of fixed-length binary values in computer memory. Similarly, -1 and 65,535 both assemble to the identical value 0FFFFh. As this demonstrates, even though the allowable range of values is -32,768 to +65,535, values from -32,768 to -1 and from 32,768 to 65,535 are represented identically in binary. A thorough understanding of binary representations and two's complement notation is the best way to avoid confusion with these idiosyncrasies of assembly language programming.

Floating-Point Numbers

You can also declare floating-point numbers with the `dt` directive, which reserves 10 bytes of memory, much the same as `dw` reserves 2 bytes. The result of `dt` with a floating-point value is a binary 10-byte real number in standard IEEE (Institute for Electrical and Electronic Engineers) format. These values are compatible with the format used by 8087, 80287, and 80387 numeric coprocessors. You can also exchange floating-point values in your assembly language programs with most high-level languages to process floating-point expressions.

Without a subroutine package to display and process floating-point values in assembly language, floating-point values are difficult to use. To declare a floating-point number, use `dt` this way:

```
fp    dt    3.14159          ; 4000C90FCF80DC33721Dh
```

Binary-Coded Decimals

Another use for `dt` is to declare packed binary-coded-decimal (BCD) numbers. These values are useful especially in business calculations where large numbers are frequently required but where the round-off errors possible with floating-point values are unacceptable. BCD values take more room (10 bytes each) and require more time to process than byte and word integers, so you won't use this format except in special cases. (Chapter 11 describes BCD numbers in detail.) To declare a packed BCD value, use the same `dt` directive as for floating-point values, but don't use a decimal point. For example:

```
bcd1    dt    1234
bcd2    dt    9876543210
bcd3    dt    250000
```

Each of these declarations reserves 10 bytes of memory, storing the initialized value with 2 *digits* per byte. In other words, a BCD value can have up to 20 digits. Values are stored in reverse order, so that the previous examples appear in memory with each digit assigned to a 4-bit *nybble* in the byte:

```
nnnn:0000  34 12 00 00 00 00 00 00 00 00
nnnn:0000  10 32 54 76 98 00 00 00 00 00
nnnn:0000  00 00 25 00 00 00 00 00 00 00
```

Arrays in Assembly Language

There are no native commands, structures, or methods for declaring and using arrays in assembly language programs. In high-level languages such as Pascal and C, you can declare arrays and then refer to array items with an index variable. For example, a Pascal program might declare an array of ten integers, indexed from 0 to 9:

```
VAR intArray : ARRAY[ 0 .. 9 ] OF Integer;
```

In the program, statements can then refer to the array, perhaps using an index variable for a FOR loop to assign values to each array position:

```
FOR I := 0 TO 9 DO
    intArray[ I ] := I;
```

For those who are not familiar with Pascal, this statement assigns the values 0 through 9 to the ten arrayed integers. C and BASIC programmers have similar ways to create and use arrays. In assembly language, managing arrays is a little more difficult, but also more flexible

because it is up to you to write the code to access array values. One way to create an integer array, for example, is to use the DUP operator:

```
anArray  db  10 DUP (?)    ; Array of 10 integers
```

You can also define ten values in sequence, declaring and initializing the array in a single step:

```
anArray  db  0, 1, 2, 3, 4, 5, 6, 7, 8, 9
```

Arrays of other structures such as strings and STRUC variable take more effort. For instance, suppose you need an array of four 20-byte strings. Because this array is so small, you may as well use four separate variables:

```
anArray  db  20 DUP (?), 0    ; anArray[0]
          db  20 DUP (?), 0    ; anArray[1]
          db  20 DUP (?), 0    ; anArray[2]
          db  20 DUP (?), 0    ; anArray[3]
```

The four variables are stored consecutively in memory; therefore, the same four 20-byte strings (plus 1 byte for the string terminator) can be accessed as individual variables or as a structure of four arrayed strings. Unless you love typing long programs, this approach may be impractical for creating large arrays. Consider how you might create space for one hundred 20-byte strings. Using two new directives LABEL and REPT, you can write:

```
LABEL    anArray  Byte
REPT     100
  db 20 DUP (?), 0
ENDM
```

The first line declares the label anArray of type Byte. Other type names you can use here are Word, Dword, Fword, Pword, DataPtr, Qword, and Tbyte. Or you can use a structure name. The LABEL directive tells the assembler how to address the data that follows—it doesn't reserve any memory space. In this example, the data that follows are strings, which are always addressed as single bytes. The REPT (Repeat) command repeats any assembly language statement for a certain number of times, here 100. Everything between REPT and ENDM (End Macro) is repeated as though you had typed this line so many times. (The ENDM command also ends *macro definitions*, a subject for Chapter 8.)

One useful trick is to change the declaration each time in the definition. For example, to create an array of ten integers and assign the values 0 through 9 to each array position, you can use this declaration:

```
value = 0
LABEL  anArray  Word
REPT  10
  dw value
  value = value + 1
ENDM
```

The result is an array of `Word` integers with the values 0, 1, 2, 3, 4, 5, 6, 7, 8 and 9. The numeric value `equ` is initialized to 0. As you recall from Chapter 5, symbols defined with equal signs can be redefined later—the key to this method. Inside the `REPT` definition, a `dw` directive defines one word of memory equal to `value`. After this, `value` is increased by 1 for the next pass. Remember that expressions such as `value = value + 1` are evaluated at assembly time and that all the actions just described take place during assembly—not when the program runs. The result is an array of ten words initialized to successive values. No code is generated by these commands.

NOTE

Turbo Debugger's Variables window is unable to show all elements of arrays declared with `REPT` directives as demonstrated here. To see the array, use the `View:Dump` commands to view memory starting at the array's address.

Changing Types with LABEL

The `LABEL` directive is used most often to assign two or more labels of different types to the same data in memory. With this technique, you can read and write variables as bytes in some instructions but as words (or other types) elsewhere. The directive has three parts:

```
LABEL identifier type
```

The *identifier* is treated the same as any other label. The *type* can be `near`, `far`, `proc`, `byte`, `word`, `dword`, `fword`, `pword`, `dataptr`, `qword`, or `tbyte`. The *type* can also be the name of a `STRUCT` data structure. Using `LABEL`, you can declare a value as two bytes, but view the value as a 16-bit word:

```
LABEL ByteValue byte
WordValue dw 01234h
```

The hexadecimal value `01234h` is labeled as `WordValue` and declared as a 16-bit word with `dw`. But the preceding `LABEL` creates a second `byte` label `ByteValue`, which addresses the same value in memory. This lets you write instructions such as:

```
mov ax, [WordValue]      ; Get full 16-bit value
mov bl, [ByteValue]     ; Get 8-bit LSB
mov bh, [ByteValue + 1] ; Get 8-bit MSB
```

The first `mov` loads the full 16-bit value, setting `ax` to `01234h`. The second `mov` loads only the first 8 bits of this same value, setting `b1` to `034h`. The third `mov` loads the second 8 bits, setting `bh` to `012h`. Thus, the final two instructions set `bx` to the same value as `ax`. (Remember that words are stored in byte-swapped order—the value `01234h` is stored in memory as the two bytes `034h` and `012h`.)

Using LABEL to assign labels of different types to variables is even more useful for addressing structures as collections of typed fields, but also as streams of 16-bit words. Using the Date structure from the beginning of this chapter, you could write:

```
LABEL   DayMonth   word
OneDay  Date       <>
```

OneDay is a single structured variable of type Date. The label DayMonth addresses this same memory but considers the data to be of type word. In the program's code, you can refer to the first two fields in OneDay normally as OneDay.day and OneDay.month. Or, because of the additional label, you can load these two byte fields directly into one 16-bit register:

```
mov ax, [DayMonth]      ; Load day and month into ax
mov al, [OneDay.day]    ; Load day into ah
mov ah, [OneDay.month] ; Load month into al
```

The first mov performs the identical function as the last two mov instructions. Sometimes, as this shows, using LABEL can help cut out an instruction or two, and, if that instruction is repeated often, this will also improve program performance.

Indexing Arrays

Now that you know how to declare arrays, the next step is to investigate ways to read and write arrayed values. For example, how do you refer to item number 5? The key to the answer is in realizing that array indexes in assembly language are simply addresses—as are all references to variables; therefore, regardless of the type of data stored in an array, the goal of indexing individual values reduces to these two steps:

- Multiply the size of the array elements by the array index I .
- Add the result to the array's base address.

For example, in a simple array of bytes, if I is 0, then $I \times 2(0)$ plus the address of *array* locates the first value at *array*[0]. The second value (*array*[1]) is located at the base address of *array* plus 1, and so on. As Figure 6.1 shows, the goal is to convert array index values such as these to addresses in memory. Index 0 is equivalent to the address, 000D—the same as the base address of the entire array. Index 1 corresponds to 000E; index 2, to 000F; on down to index 9, which locates the value at offset 0016. A real-life example will help make this process clear. Byte arrays are the easiest to manage, so let's take those first. To load into al the 64th element of a 100-byte array, you can write:

```
DATASEG
anArray db 100 DUP (0)
CODESEG
mov al, [anArray + 63]
```

Figure 6.1.
A simple array of bytes as they might appear in memory.

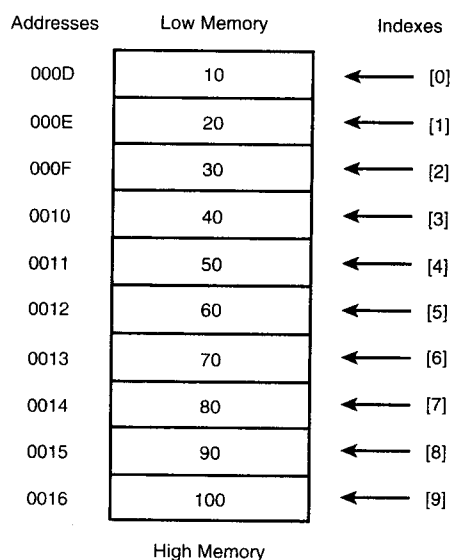

The 63 in this example is correct because the first array element is at offset 0. An index of 64 would incorrectly locate the 65th item in the array, not the 64th. When calculating array indexes, you'll avoid much confusion and frustration if you always remember that the index range for an array of 100 items is 0 to 99, not 1 to 100.

Adding literal values like 63 as in the previous example doesn't allow for much flexibility. In most situations, you'll use a register or memory variable to hold the array index. Using the base-addressing mode introduced in Chapter 5, you might store an array index value in register `bx`. For example, suppose you have a variable named `index` and you want to load the value of `anArray[index]` into a register. You can write:

```

DATASEG
index      dw  ?
anArray    db  100 DUP (?)
CODESEG
mov  bx, [index]          ; Get index value
mov  al, [bx + anArray]  ; al <- anArray[index]

```

The two data declarations reserve space for a 16-bit index and a 100-byte uninitialized array. In the code segment, the first `mov` loads the current value of `index` into `bx`. The second `mov` adds `bx` to the base address of the array, locating the correct byte and loading the arrayed value into `al`. You can also use registers `si` and `di` to do the same:

```

mov si, [index]      ; Get index value
mov al, [si + anArray] ; al <- anArray[index]
mov di, [index]      ; Get index value
mov al, [di + anArray] ; al <- anArray[index]

```

The top two lines perform the same function as the bottom two. Technically, this is the *indexed-* not *base-*addressing mode, although, as you can see, there's not much practical difference between the two methods.

NOTE

You can also use register `bp` to address arrays, but remember that this register's default segment is `ss`, not `ds`, which is the default for `bx`, `si`, and `di` in the base- and indexed-addressing modes.

Multibyte Array Values

Array addressing becomes trickier when arrayed values occupy more than 1 byte. Because of the computer's binary nature, calculating the addresses of multibyte array elements is simplest when the element sizes are powers of 2. In this case, you can use fast shift instructions to perform the initial multiplication of the index times the value byte size. Adding the result of this multiplication to the array's base address locates any arrayed value, as the following fragment demonstrates:

```

DATASEG
index      dw      ?
anArray    dw      100 DUP (?)
CODESEG
mov  bx, [index]      ; Get index value
shl  bx, 1            ; bx <- index * element-size (2)
mov  ax, [bx + anArray] ; ax <- anArray[index]

```

In this example, the element size is 2 bytes; therefore, the easy (and fastest) way to multiply the index value by 2 is to shift the value left 1 bit. Compare Figure 6.2 with Figure 6.1. As you can see, addresses to the left increase by 2. To calculate the address of the fifth 2-byte array value (at index 4), you first multiply 4×2 and add the result to the base address of the array to get the final offset value of 0018h.

Figure 6.2.
When arrayed element sizes are powers of 2, translating indexes to offset addresses is relatively simple.

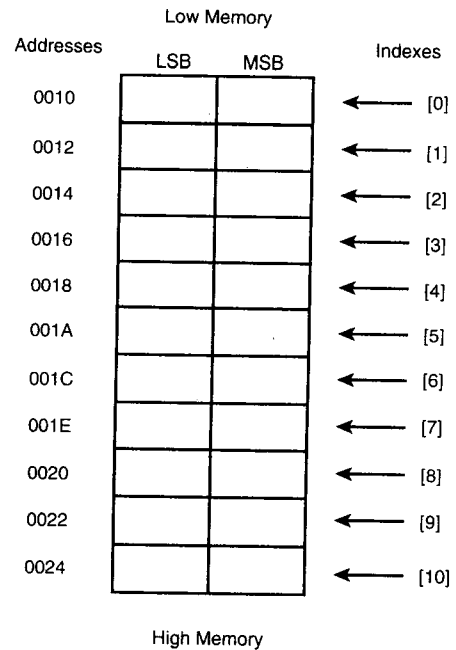

Calculating index addresses when element sizes are not powers of 2 requires some fancy footwork to keep the code running as fast as possible. Of course, you can always use `mul` to perform the initial multiplication. Consider an array of elements, each occupying 5 bytes. To set `bx` to the offset address of the element at `index` requires several steps:

```

mov ax, [index]      ; Get index value into ax
mov bx, 5            ; Set bx = element size
mul bx              ; dx:ax <- index * element size
mov bx, ax          ; move result to bx (ignoring dx)
add bx, OFFSET anArray ; Set bx <- offset address of element

```

Only the LSB of the multiplication is important—the high 16 bits in `dx` of the full 32-bit result are ignored. (Presumably another part of this program checks to be sure that `index` values are within bounds.) The problem with this approach is the `mul` instruction, which can take as many as 118 machine cycles to execute. For this reason, it pays to factor out the powers of 2 and use a combination of shifts and other fast instructions to calculate the addresses of arrayed values:

```

mov bx, [index]      ; Get index value into bx
mov ax, bx          ; Save value in ax
shl bx, 1           ; bx <- bx * 2
shl bx, 1           ; bx <- bx * 4 (total)
add bx, ax          ; bx <- bx * 5 (total)
add bx, OFFSET anArray ; Set bx <- address of element

```

The comments in this fragment show the running total in `bx`. First, two left shifts multiply `bx` by 4. Adding this result to the original `index` value completes the full multiply-by-5. Obviously, 5 of any value equals 4 of that value plus 1 of that same value. Because 4 is a power of 2, the program can perform the first part of the multiplication with fast shift instructions before completing the result with a simple addition. This entire sequence of instructions runs *many* times faster than a single `mul` instruction.

Such tricks as these aren't always possible. But, in general, when you can use shifts instead of multiplication, the results will be faster. The best approach is to pick array element sizes that are powers of 2. When that is impossible, try to find a combination of shifts and other instructions that will give you the correct result.

Unions and Records

Defined with a `UNION` directive, a *union* has the identical form as a `STRUC` structure. Like structures, unions contain named fields, often of different data types. The difference between a union and a structure is that union fields overlay each other within the variable. A union with three byte fields, in other words, actually occupies only a single byte. As the next example shows, you can use this feature to construct variables that the assembler can reference as containing more than one type of data, similar to the way you learned how to use `LABEL` earlier:

```
UNION      ByteWord
  aByte    db    ?
  aWord    dw    ?
ENDS      ByteWord
```

An `ENDS` directive ends the union. In this example, `aByte` overlays the first byte of `aWord`. If this were a structure, then `aByte` and `aWord` would be stored in consecutive locations. Because this is a union, however, `aByte` and `aWord` are stored at the *same* location in memory. Therefore, inserting a value into `aByte` also changes the LSB of `aWord`:

```
mov  [aByte], bh    ; Store bh at aByte and aWord's LSB
```

When combined with structures, unions give you powerful ways to process variables. For example, Figure 6.3 lists a useful structure and union combination that you can use to refer to variables as 16-bit words and as 8-bit bytes.

Figure 6.3.

Union with nested structures.

```
STRUC      TwoBytes
  loByte   db    ?
  hiByte   db    ?
ENDS      TwoBytes

UNION      ByteWord
  asBytes  TwoBytes  <>
  asWord   dw    ?
ENDS      ByteWord
```

The `TwoBytes` structure defines two byte fields, `LoByte` and `hiByte`. The union `ByteWord` also defines two fields. First is `asBytes`, of the previously defined `TwoBytes` structure. Next is `asWord`, a single 16-bit word. Variables of type `ByteWord` make it easy to refer to locations as both word and double-byte values without the danger of forgetting that words are stored in byte reversed order—a problem with the `LABEL` method. To use the nested union, first declare a variable, in this case assigned the value of `0FF00h`.

```
DATASEG
data    ByteWord    <,0FF00h>
```

You can now refer to `data` as a `TwoBytes` structure or as a 16-bit word. A short example demonstrates how to load the same memory locations into either byte or word registers. Because the `TwoBytes` structure is nested inside the union, two periods are required to “get to” the byte fields. Notice how the field names reduce the danger of accidentally loading the wrong byte of a word into an 8-bit register:

```
CODESEG
mov     al, [data.asBytes.LoByte] ; Load LSB into al
mov     ah, [data.asBytes.hiByte] ; Load MSB into ah
mov     ax, [data.asWord]         ; Same result
```

Bit Fields

Many times in assembly language programming you’ll need to examine and change one or more bits in a byte or word value. You’ve already learned several ways to accomplish this with logical instructions such as `or`, `and` and `xor` to set and clear individual bits without disturbing others. For example, to set bit number 2 in a byte register, you can use the instruction.

```
or     al, 00000100b
```

When doing this, it’s often helpful to write out the values in binary—just remember the final *b*. As you also learned earlier, `and` can mask values, setting one or more bits to 0:

```
and   al, 11110000b
```

Even though writing the values in binary helps to clarify exactly which bits are affected by the instructions, you still have to count bits and take time to visualize the results of your logic. In complex programs, it’s very easy to set or reset the wrong bit—a most difficult bug to find. To make processing bits easier, Turbo Assembler offers two devices—the `RECORD` and the `MASK`.

Declaring RECORD Types

`RECORD` is a directive that lets you give names to bit fields in bytes and words. You simply specify the width of each field—in other words, the number of bits the field occupies. Turbo Assembler then calculates the position of the field for you. For example, this `RECORD` defines `signedByte` as an 8-bit value with two fields:

```
RECORD    signedByte    sign:1, value:7
```

After the `RECORD` directive comes the record's name, followed by a series of named fields. Each field name ends with a colon and the width of the field in bits. The `sign` field in this example is 1 bit long. The `value` field is 7 bits long. Separate multiple fields with commas. If the total number of bits is less or equal to 8, Turbo Assembler assumes the record is a byte; otherwise, it assumes the record is a word. You can't construct records larger than a word, although you can create multifield structures containing multiple bit fields, which would accomplish the same thing. You don't have to specify exactly 8 or 16 bits, although most programmers do, inserting dummy fields to flesh out a bit record to account for every bit, whether used or not.

Creating variables of a `RECORD` type is similar to creating variables of structures and unions. In fact, the three forms appear identical, leading to much confusion over the differences between structures and records. A few samples will clear the air:

```
DATASEG
v1    signedByte    <>        ; default values
v2    signedByte    <1>       ; sign = 1, value = default
v3    signedByte    <,5>      ; sign = default, value = 5
v4    signedByte    <1,127>   ; sign = 1, value = 127
v5    signedByte    <3,300>   ; sign = 1, value = 44
```

A record variable declaration has three parts: a label, the `RECORD` name, and two angle brackets with optional values inside. The first sample declares `v1` as a variable of type `signedByte`. Because no values are specified in brackets, the default values for all bit fields are used. (In this case, the defaults are 0. In a moment, you'll see how to set other defaults.) The second sample sets the `sign` bit of `v2` to 1, leaving the `value` field equal to the default. The third line sets `value` to 5, letting the `sign` field assume the default value. The fourth line assigns values to both fields in the variable, setting `sign` to 1 and `value` to 127. The fifth line shows what happens when you try to use out-of-range values such as 3 and 300. In this case, the actual values inserted into the record equal the attempted values modulo (division remainder) 2^n , where n equals the number of bits in the field.

Setting Default Bit-Field Values

Normally, the default field values in `RECORD` variables are 0. To change this, add to the field width an equal sign and the default value you want. For example, to create a `RECORD` with an MSD default of 1 and a second field defaulting to 5, you can write:

```
RECORD    minusByte    msign:1 = 1, mvalue:7 = 5
```

Declaring a variable of this type with empty angle brackets sets the `msign` field to 1 and the `mvalue` field to 5. Specifying replacement values in brackets as explained before overrides these new defaults. Notice that different field names are used here. Even though the names are contained in the `RECORD` definition, Turbo Assembler considers these names to be global—active at all places in the program or module. Therefore, you must use unique field names among all your `RECORD` definitions in one module.

**NOTE**

Unlike `RECORD` field names, `STRUC` and `UNION` field names are not global. You can reuse structure and union field names for other purposes, but not record field names, which must be unique throughout the program. Perhaps a future release of Turbo Assembler will remove this inconsistency and make `RECORD` field names local to the record. At present, this is not the case.

Using RECORD Variables

After declaring a `RECORD` type and a few variables of that type, you can use several different methods to read and write bit-field values in those variables. To demonstrate how to do this, we first need a new `RECORD` type:

```
RECORD person sex:1,married:1,children:4,xxx:1,age:7,school:2
```

`RECORD`s like this one can pack a lot of information into a small space. In this example, only 16 bits are needed to store five facts about a person—with field `sex` equal to 0 for male and 1 for female, `married` equal to 0 if false or 1 if true, `children` ranging from 0 to 15, a 1-bit dummy field `xxx` reserved for future use, an age field ranging from 0 to 127, and `school` from 0 to 3, representing four levels of a person's schooling. Figure 6.4 illustrates how these fields are packed into one 16-bit word. As with all 16-bit values, the two 8-bit bytes of this variable are stored in memory in reverse order, with bits 0-7 (LSB) at a lower address than bits 8-15 (MSB).

What's in a Field Name?

Turbo Assembler converts bit-field names into the number of right shifts required to move the field to the rightmost position in the byte or word. The value is equal to the byte or word bit position of the least significant digit for this field. Referring to the `person` record, then, `sex` = 15, `married` = 14, `children` = 10, `xxx` = 9, `age` = 2, and `school` = 0. (See Figure 6.4.) You can use these field name constants as simple `EQU` equates. Normally, though, you'll use the values to shift bit fields into the rightmost position in a register, making it easy to process individual field values. The process works in reverse, too. If the `children` bit-field value is already in the rightmost position of `ax`, shifting `ax` left by the value of `children` moves the bit-field value into its proper position, ready to be packed into the record.

Figure 6.4.
A record packed with six bit fields stores a lot of information in a small space.

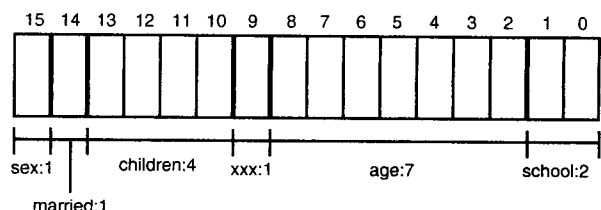

Using field names instead of manually counting bits saves time and helps prevent bugs. For example, to increment the age field, you can shift the appropriate bit-field value to the rightmost position in a word register, increment the register, and then shift the result back into position. Before doing this, however, you must strip out other bits from the variable. To help with this step, Turbo Assembler provides an operator called `MASK`, which takes the name of a bit field and generates an appropriate and mask with bits equal to 1 in all positions for this field. A good way to organize your masks is to use names similar to the associated fields:

```
maskSex      = MASK sex
maskMarried  = MASK married
maskChildren = MASK children
maskAge      = MASK age
maskSchool   = MASK school
```

Each new identifier—for example, `maskSex` and `maskMarried`—is assigned a mask for each bit field (except for `xxx`, which we'll just ignore). The names make the purpose of the various symbols easy to remember, although you can use whatever names you like. You don't have to preface the identifiers with "mask." With the bit-field names and masks, it's easy to isolate and process bit-field information without having to calculate the positions of fields in records. An example explains how this works. First, declare a variable named `subject` of type `person`:

```
DATASEG
subject    person    <>
```

Then, to set single bit fields to 1, use `or` to combine the mask with the record's current value:

```
CODESEG
or [subject], maskSex      ; Set sex field = 1
or [subject], maskMarried  ; Set married field = 1
```

To reset single-bit fields to 0, use the `NOT` operator along with the bit mask, toggling all bits in the mask. The following shows two ways to proceed:

```
and [subject], NOT maskSex ; Change sex field to 0
mov ax, [subject]          ; Load subject into ax
and ax, NOT maskMarried    ; Change married field to 0
mov [subject], ax          ; Store result back in memory
```

Extracting Bit Fields

For bit fields of more than 1 bit, the process is similar but requires additional steps to isolate the values. There are several possible methods you could use, but these steps always work:

1. Copy the original variable into a register
2. AND the register with the field mask
3. Shift the register right by the field-name constant

After copying the variable into a register (either 8 or 16 bits wide, depending on the variable's size), step 2 isolates the field's bits, stripping other fields out of the record, thus setting all other bits but those in the desired field to 0. Step 3 then shifts the isolated field bits to the rightmost position in the register. To add a new member to our subject's family, use these steps:

```

mov ax, [subject]      ; Step 1--copy the variable
and ax, maskChildren  ; Step 2--isolate the bit field
mov cl, children       ; Prepare shift count
shr ax, cl             ; Step 3--shift field to right
inc ax                 ; Add 1 to number of children

```

The `mov` and `and` instructions copy the `subject` variable into `ax` and strip other fields out of the value, leaving only the bits that apply to `children`. After loading the shift count into `cl`, the `shr` instruction shifts the `children` field to the far right of `ax`, preparing for `inc` to increment this value. If the `children` field was already rightmost in the variable—making the shift count equal to 0—the shift instructions can be skipped. For example, you could write:

```

mov cl, children      ; Move shift count into cl
or cl, cl             ; Is count = 0?
jz @@10              ; Jump if yes, cl = 0
shr ax, cl           ; Else shift ax, cl times
@@10:
inc ax                ; Add 1 to number of children

```

A better approach is to use a conditional `IF` directive, which Chapter 8 explains in more detail. This lets the assembler, rather than the program, decide whether shifting is required. After completing steps 1 and 2 to copy and mask the record variable, the following instructions shift the result right only if the `children` constant is greater than 0:

```

IF children GT 0
  mov cl, children    ; Move nonzero count into cl
  shr ax, cl         ; Shift ax, cl times
ENDIF
inc ax                ; Add 1 to number of children

```

If the expression in the conditional `IF` is true, then Turbo Assembler assembles the code up to the next `ENDIF` directive. If the expression is false, then the code is ignored. This method eliminates the unnecessary comparison, jump, and shift instructions of the previous technique.

Recombining Bit Fields

After extracting a bit field and processing its value, you now need a way to insert the result back into a record variable. Assuming the result is rightmost in a register, follow these four steps:

1. Shift the register left by field-name constant
2. AND the register with the field mask

3. AND the original value with NOT field mask
4. OR the register into the original value

Step 1 shifts the value into its correct position, again using the field name as the shift count but this time shifting left instead of right. Step 2 is an optional safety valve, which limits the new value to the field's width in bits. If you are positive that the new field value is within the proper range, you can skip this step. But any out-of-range values—accidentally giving our subject the burden of 45 children, for example—can change the values of other fields. For this reason, it's a good idea to mask the new value this way before combining the value back into the original variable. Step 3 complements step 2 by setting all bits of the field in the original value to 0—in a sense, punching a hole in the original value like a cookie cutter punching out a circle in dough. Step 4 then Ors the new value into this punched-out hole, completing the process.

To demonstrate these four steps in assembly language, the following code fragment moves the children field (now rightmost in register ax) back into the subject variable:

```

mov  cl, children           ; Move shift count into cl
shl  ax, cl                 ; Step 1--shift into position
and  ax, maskChildren      ; Step 2--Limit value
and  [subject], NOT maskChildren ; Step 3--punch a hole
or   [subject], ax         ; Step 4--drop value into hole

```

As with the previous steps that extract a bit field, you can use a conditional IF directive to skip the shift if children = 0, indicating that this field is already rightmost in the variable. Also, you can eliminate the first and if the result cannot possibly be larger than 15—the maximum value that the 4-bit children field can express.

Putting the extraction and recombination steps together, here's another example that adds 10 to our subject's age field:

```

mov  ax, [subject]         ; Copy the variable into ax
and  ax, maskAge           ; Isolate the age field
mov  cl, age               ; Prepare shift count
shr  ax, cl                ; Shift age field to right
add  ax, 10                ; Age 10 to subject's age
shl  ax, cl                ; Shift age back into position
and  ax, maskAge           ; Limit age to maximum range
and  [subject], NOT maskAge ; Punch a hole in (zero) age field
or   [subject], ax         ; Drop new age value into hole

```

Many programmers avoid using RECORD bit fields, probably because they do not understand the techniques. This fact is evident from the many assembly language programs that declare fixed constants for shift values and masks, making the code much more difficult to modify. If you take the time to learn how to use RECORD and MASK, defining your packed records as described here, you'll be able to write programs that automatically adjust for new situations—a change to the number of bits in the school field or a newly found uses for the reserved xxx single-bit field. You can also change the default values assigned to fields without having to

hunt through a lot of cryptic statements, making changes to programs that don't need fixing! Just change your `RECORD` definitions, and you're done. The same advantages apply to `STRUC` and `UNION`, which help take much of the complexity out of working with complex data structures.

Efficient Logical Operations

The saying "There's always room for improvement" is especially true in assembly language. One improvement that's often missed is the replacement of word-based instructions for shorter, and potentially faster, byte-based instructions that perform identical jobs in certain situations.

For example, when testing a bit in a record, or when setting or exclusive-ORing bits, it's possible to use a byte-based instruction even when operating on a 16-bit word value when the target bit is in the low-order portion of the word. An example will help clarify the problem and its solution. Consider the following bit-field record:

```
RECORD BitRec b0:1, b1:4, b2:3, b3:7
```

Logical `and`, `or`, `test`, and `xor` instructions can manipulate bits in `BitRec` record variables by referring to the `b0`, `b1`, `b2`, and `b3` labels. You can, for instance, set bit `b2` in the `ax` register with the instruction:

```
or ax, b2
```

When assembled, this generates a word-based instruction that takes three machine code bytes:

```
0D 07 00
```

That same instruction, however, is more efficiently coded as follows, which performs the identical job and has the same effect on processor flags:

```
or a1, b2
```

When assembled, this instruction takes only two machine code bytes:

```
0C 07
```

Even though the variable is in the 16-bit register `ax`, an 8-bit instruction that refers to the 8-bit low-order byte register `a1` has the identical effect.

Automating Efficient Logical Operations

To automate the selection of efficient logical instructions, Turbo Assembler 3.0 and later versions provide four pseudo instructions: `SETFLAG`, `MASKFLAG`, `TESTFLAG`, and `FLIPFLAG`. With them, the assembler can choose the most efficient forms of logical instructions automatically. For example, the assembler replaces this instruction:

```
SETFLAG ax, b2
```

with the more efficient:

```
or ax, 07
```

rather than the equivalent, but less efficient, instruction that might appear to be necessary:

```
or ax, b2
```

The following code snippet shows how to use the pseudo instructions. Comments show the assembled code. For example, in the first line, the SETFLAG instruction is encoded as a byte-based logical or instruction. The equivalent, but potentially inefficient, instruction follows on the second line. Notice that in the case of logical and, in this example, a byte-based instruction replacement is not possible:

```
SETFLAG ax, b2 ; or ax, 07 / 0C07
or ax, b2 ; or ax, 0007 / 0D0700
MASKFLAG ax, b2 ; and ax, 0007 / 250700
and ax, b2 ; and ax, 0007 / 250700
TESTFLAG ax, b2 ; test ax, 07 / A807
test ax, b2 ; test ax, 0007 / A90700
FLIPFLAG ax, b2 ; xor ax, 07 / 3407
xor ax, b2 ; xor ax, 0007 / 350700
```

Automating Record Field Operations

Turbo Assembler 3.0 and later versions provide two additional pseudo instructions, SETFIELD and GETFIELD that greatly simplify working with bit-field records. Before using them, you should be familiar with the discussions in this chapter on using record variables along with MASK values to set and retrieve bit values packed into bytes and words.

A few examples show how these new instructions can simplify the steps for inserting and extracting person record fields. So you don't have to flip pages, here is the record declaration again:

```
RECORD person sex:1, married:1, children:4, xxx:1, age:7, school:2
```

As you learned, it takes a combination of shift, rotate, and logical instructions to set and retrieve values in person record fields, but Turbo Assembler 3.0 and later versions can create the necessary instructions for you. For example, first prepare a register to hold a person record:

```
xor ax, ax ; Clear person record
```

That simply clears register ax to zero. To insert a value into the record's children field, first assign the value to a register (b1 here), and use SETFIELD as follows:

```
mov b1, 3 ; Move no. children to b1
SETFIELD children ax, b1 ; Set children field in ax
```

The second line inserts the value of `b1` into `ax` *without disturbing other bits in ax*. To do that, Turbo Assembler writes the following logical operations in place of the `SETFIELD` pseudo instruction:

```
rol  b1, 02
or   ah, b1
```

The first instruction rotates the `children` value left two positions, and the second instruction logically ORs that value into `ax`. The assembler also chooses a more efficient byte-form of the logical `or` rather than operating on the full 16-bit word.

You can use `SETFIELD` similarly to insert values into any record field—an age value, for example:

```
mov     b1, 43           ; Move age to b1
SETFIELD age ax, b1     ; Set age field in ax
```

This generates another set of rotate and logical operations to insert into `ax` an age value from `b1`, without disturbing other record fields.

To extract bit-field values from records, use `GETFIELD`. For example, the following instruction sets `b1` to the number of children in the person record held in register `ax`:

```
GETFIELD children b1, ax ; Get children into b1 (destroys bh!)
```

Assuming the preceding `SETFIELD` instructions were executed, this sets `b1` to 03. In place of the pseudo `GETFIELD` instruction, Turbo Assembler writes the following instructions:

```
mov     b1, ah
ror     b1, 02
and     b1, 0Fh
```

The first line moves the portion of the record that contains the desired bit-field value (`ah`) into `b1`. The second line rotates that value right two positions, moving it to the rightmost spot in `b1`. The third line applies the literal mask `0Fh` to isolate the desired value, which in this example, sets `b1` to 03.

Similarly, you can use `GETFIELD` to extract the age value from the record in `ax`:

```
GETFIELD age b1, ax     ; Get age into b1 (destroys bh!)
```

The assembler generates another set of logical operations that in this case set `b1` to 43, the age value packed in the record.

One danger with `GETFIELD` is that it always uses the full 16-bit target register, even though you specify only the low-order portion. In the preceding two `GETFIELD` examples, as the comments indicate, the most significant byte in `bh` is destroyed by the logical instructions that Turbo Assembler creates.

You may use other registers and memory references with `SETFIELD` and `GETFIELD`—you don't have to use `ax` and `b1` as demonstrated here. The full syntax for both pseudo instructions follow:

```
SETFIELD field_name destination_r/m, source_reg
GETFIELD field_name destination_reg, source_r/m
```

Use these rules to construct SETFIELD and GETFIELD instructions. Each requires a field name followed by destination and source specifications. The destination for SETFIELD may be a register or a memory reference. Its source must be a register. The destination for GETFIELD must be a register. Its source may be a register or memory reference.

NOTE

The actual instructions generated for SETFIELD and GETFIELD depend on the operand values, the registers and memory references, and the positions of values in bit-field records. The preceding examples show only one of several possible instruction sequences. To investigate others, create sample SETFIELD and GETFIELD instructions and view the assembled code in Turbo Debugger's CPU window.

Using Predefined Equates

Turbo Assembler knows a few predefined equates that you can use as default values for program variables. Table 6.1 lists these equates, all of which begin with two question marks.

Listing 6.2, VERSION.ASM, demonstrates how to use these equates to create a version-making string automatically when the program is assembled. Assemble, link, and run the program with the commands:

```
tasm version
tlink version,,, mta
version
```

Table 6.1. Predefined Equates.

<i>Symbol</i>	<i>Meaning</i>
??Date	Today's date in the DOS country-code style
??Filename	The module or program's disk-filename
??Time	The current time in the DOS country-code style
??Version	Turbo Assembler version number

VERSION uses the STRIO and STRINGS modules from Chapter 5; therefore, the tlink command assumes that the assembled code for these modules is stored in MTA.LIB. If you want to examine the program in Turbo Debugger, add the /zi option to tasm and the /v option to tlink—as you probably know by now.

Listing 6.2. VERSION.ASM.

```

1: %TITLE "Automatic Program Version Demo -- by Tom Swan"
2:
3:         IDEAL
4:
5:         MODEL    small
6:         STACK    256
7:
8: cr      EQU     13      ; ASCII carriage return
9: lf      EQU     10      ; ASCII line feed
10:
11:
12:        DATASEG
13:
14: exCode          db      0
15:
16: ident   db      cr, lf, ??FileName, ' ', ??Date, ' ', ??Time
17:        db      cr, lf, 0
18:
19:
20:        CODESEG
21:
22: ;----- From STRIO.OBJ
23:
24:        EXTRN   StrWrite:proc
25:
26: Start:
27:        mov     ax, @data      ; Initialize DS to address
28:        mov     ds, ax        ; of data segment
29:        mov     es, ax        ; Make es = ds
30:
31:        mov     di, OFFSET ident ; Address program id string
32:        call    StrWrite      ; Display string
33:
34: Exit:
35:        mov     ah, 04Ch      ; DOS function: Exit program
36:        mov     al, [exCode]  ; Return exit code value
37:        int     21h          ; Call DOS. Terminate program
38:
39:        END     Start        ; End of program / entry point

```

Running VERSION

Lines 16-17 create an ASCIIZ string, starting and ending with a carriage return and line feed plus a null terminator. Inside the string, the predefined equates `??FileName`, `??Date`, and `??Time` are used in a `db` directive to create a string with these three values, separated by a few spaces. Running the program displays a line similar to:

```
version 02/15/95 08:13:23
```



The nice feature about building the automatic string is that merely reassembling the program automatically changes the version date and time. This simple device is very useful for keeping track of program updates.

Converting Numbers and Strings

In high-level languages, you can read and write numeric values directly. For example, to let someone enter a number and then display the result, assuming *n* is an integer, you might use these Pascal statements:

```
Write( 'Enter a value: ' );
ReadLn( n );
WriteLn( 'Value is: ', n );
```

Native assembly language lacks similar abilities. Instead, you have to read and write strings and then convert those strings to and from binary values for processing, storing on disk, and so on. Of course, high-level languages must do this internally, too!

Listing 6.3, BINASC.ASM, is a module that you can use to make this process easier to program. The module has routines that can convert 16-bit values to and from signed and unsigned decimal, hexadecimal, and binary ASCIIZ strings. Assemble to BINASC.OBJ and store this code in your MTA.LIB file with the commands:

```
tasm /z binasc
tlib /E mta -+binasc
```

As with the modules in Chapter 5, ignore the warning that BINASC is not in the library. It won't be until you install it the first time. Also, be aware that BINASC uses two procedures from STRINGS; therefore, you won't be able to link programs to BINASC until at least both of these modules are installed in MTA.LIB.

Listing 6.3. BINASC.ASM.

```
1: %TITLE "Binary to/from ASCII Conversion -- by Tom Swan"
2:
3:     IDEAL
4:
5:     MODEL    small
6:
7: ;----- Equates
8:
9: ASCnull      EQU    0           ; ASCII null character
10:
11:     DATASEG
12:
13:     CODESEG
14:
15: ;----- From STRINGS.OBJ
16:
```

Listing 6.3. continued

```

17:         EXTRN  StrLength:proc, StrUpper:proc
18:
19:         PUBLIC HexDigit, ValCh, NumToAscii
20:         PUBLIC BinToAscHex, SBinToAscDec, BinToAscDec, BinToAscBin
21:         PUBLIC AscToBin
22:
23: %NEWPAGE
24: ;-----
25: ; HexDigit      Convert 4-bit value to ASCII digit
26: ;-----
27: ; Input:
28: ;     dl = value limited to range 0..15
29: ; Output:
30: ;     dl = ASCII hex digit equivalent
31: ; Registers:
32: ;     dl
33: ;-----
34: PROC     HexDigit
35:         cmp     dl, 10           ; Is dl < 10 (i.e. hex 'A')?
36:         jb     @@10           ; If yes, jump
37:         add     dl, 'A'-10      ; Else convert to A, B, C, D, E, or F
38:         ret
39: @@10:
40:         or     dl, '0'         ; Convert digits 0 to 9
41:         ret
42: ENDP     HexDigit
43: %NEWPAGE
44: ;-----
45: ; ValCh         Convert ASCII digit char to binary value
46: ;-----
47: ; Input:
48: ;     dl = ASCII digit '0'..'9'; 'A'..'F'
49: ;     bx = base (2=binary, 10=decimal, 16=hexadecimal)
50: ; Output:
51: ;     cf = 0: dx = equivalent binary value
52: ;     cf = 1: bad char for this number base (dx is meaningless)
53: ; Registers:
54: ;     dx
55: ;-----
56: PROC     ValCh
57:         cmp     dl, '9'         ; Check for possible hex digit
58:         jbe     @@10           ; Probably '0'..'9', jump
59:         sub     dl, 7           ; Adjust hex digit to 3A..3F range
60: @@10:
61:         sub     dl, '0'         ; Convert ASCII to decimal
62:         test    dl, 0f0h        ; Check 4 msbs (sets cf=0)
63:         jnz     @@99           ; Jump if error (not digit or A-F)
64:
65:         xor     dh, dh         ; Convert byte in dl to word in dx
66:         cmp     dx, bx         ; Compare to number base (cf=1 if ok)
67: @@99:
68:         cmc
69:         ret
70: ENDP     ValCh

```

```

71: %NEWPAGE
72: ;-----
73: ; NumToASCII   Convert unsigned binary value to ASCII
74: ;-----
75: ; Input:
76: ;     ax = 16-bit value to convert
77: ;     bx = base for result (2=binary;10=decimal;16=hex)
78: ;     cx = minimum number of digits to output
79: ;     di = address of string to hold result
80: ;     Note: assumes string is large enough to hold result
81: ;     Note: creates full result if cx is less than the number
82: ;           of digits required to specify the result or cx = 0
83: ;     Note: if cx=0 and ax=0 then length of string will be 0
84: ;           set cx=1 if you want string to = '0' if ax=0
85: ;     Note: assumes (2<=bx<=16)
86: ; Output:
87: ;     none
88: ; Registers:
89: ;     ax, cx
90: ;-----
91: PROC   NumToASCII           ; Normal entry point
92:     push dx                 ; Save some modified registers
93:     push di
94:     push si
95:
96: ; si = count of digits on stack
97:
98:     xor     si, si          ; Set digit-count to zero
99:     jcxz   @@20            ; If cx=0, jump to set cx=1
100: @@10:
101:     xor     dx, dx          ; Extend ax to 32-bit dxax
102:     div    bx               ; ax<-axdx div bx; dx<-remainder
103:     call   HexDigit        ; Convert dl to ASCII digit
104:     push   dx               ; Save digit on stack
105:     inc    si               ; Count digits on stack
106:     loop   @@10            ; Loop on minimum digit count
107: @@20:
108:     inc    cx               ; Set cx = 1 in case not done
109:     or     ax, ax          ; Is ax = 0? (all digits done)
110:     jnz   @@10            ; If ax <> 0, continue conversion
111:     mov    cx, si          ; Set cx to stack char count
112:     jcxz  @@40            ; Skip next loop if cx=0000
113:     cld                                ; Auto-increment di for stosb
114: @@30:
115:     pop    ax               ; Pop next digit into al
116:     stosb                    ; Store digit in string; advance di
117:     loop  @@30            ; Loop for cx digits
118: @@40:
119:     mov    [byte di], ASCNull ; Store null at end of string
120:     pop    si               ; Restore saved registers
121:     pop    di
122:     pop    dx
123:
124:     ret                     ; Return to caller
125: ENDP   NumToASCII

```

continues

Listing 6.3. continued

```

126: %NEWPAGE
127: ;-----
128: ; BinToAscHex   Convert binary values to ASCII hex strings
129: ;-----
130: ; Input:
131: ;     ax = 16-bit value to convert
132: ;     cx = minimum number of digits to output
133: ;     di = address of string to hold result
134: ;     Note: assumes string is large enough to hold result
135: ;     Note: outputs full result if cx is less than the number
136: ;           of digits required to specify the result
137: ; Output:
138: ;     none
139: ; Registers:
140: ;     ax, cx
141: ;-----
142: PROC   BinToAscHex
143:     push    bx                ; Save bx on stack
144:     mov     bx, 16            ; Set base = 16 (hex)
145:     call   NumToAscii        ; Convert ax to ASCII
146:     pop     bx                ; Restore bx
147:     ret     ; Return to caller
148: ENDP   BinToAscHex
149: %NEWPAGE
150: ;-----
151: ; BinToAscDec   Convert binary values to ASCII decimal strings
152: ;-----
153: ; Input:
154: ;     Same as BinToAscHex
155: ; Output:
156: ;     none
157: ; Registers:
158: ;     ax, cx (indirectly)
159: ;-----
160: PROC   BinToAscDec
161:     push    bx                ; Save bx on stack
162:     mov     bx, 10           ; Set base = 10 (decimal)
163:     call   NumToAscii        ; Convert ax to ASCII
164:     pop     bx                ; Restore bx
165:     ret     ; Return to caller
166: ENDP   BinToAscDec
167: %NEWPAGE
168: ;-----
169: ; SBinToAscDec  Convert signed binary to ASCII decimal strings
170: ;-----
171: ; Input:
172: ;     Same as BinToAscHex (ax = signed 16-bit value)
173: ; Output:
174: ;     none
175: ; Registers:
176: ;     ax, cx
177: ;-----

```

```

178: PROC   SBinToAscDec
179:       push   bx           ; Save bx and di
180:       push   di
181:       cmp    ax, 0        ; Is signed ax < 0?
182:       jge   @@10         ; Jump if ax >= 0
183:       neg    ax           ; Form twos complement of ax
184:       mov    [byte di], '-' ; Insert '-' in string
185:       inc    di           ; Advance string pointer
186: @@10:
187:       mov    bx, 10        ; Set base = 10 (decimal)
188:       call   NumToAscii    ; Convert ax to ASCII
189:       pop    di           ; Restore bx and di
190:       pop    bx
191:       ret                    ; Return to caller
192: ENDP   SBinToAscDec
193: %NEWPAGE
194: ;-----
195: ; BinToAscBin   Convert binary values to ASCII binary strings
196: ;-----
197: ; Input:
198: ;   Same as BinToAscHex
199: ; Output:
200: ;   none
201: ; Registers:
202: ;   ax, cx (indirectly)
203: ;-----
204: PROC   BinToAscBin
205:       push   bx           ; Save bx on stack
206:       mov    bx, 2        ; Set base = 2 (binary)
207:       call   NumToAscii    ; Convert ax to ASCII
208:       pop    bx           ; Restore bx
209:       ret                    ; Return to caller
210: ENDP   BinToAscBin
211: %NEWPAGE
212: ;-----
213: ; ChToBase      Return number base for string
214: ;-----
215: ; Note:
216: ;   Private subroutine for AscToBin. Don't call directly.
217: ; Input:
218: ;   si = pointer to null terminator at end of string
219: ;   Note: assumes length of string >= 1
220: ; Output:
221: ;   bx = 2(binary), 10(decimal/default), 16(hexadecimal)
222: ;   si = address of last probable digit character in string
223: ; Registers:
224: ;   bx, dl, si
225: ;-----
226: PROC   ChToBase
227:       mov    dl, [byte si-1] ; Get last char of string
228:       mov    bx, 16        ; Preset base to 16 (hexadecimal)
229:       cmp    dl, 'H'       ; Is it a hex string?
230:       je     @@10         ; Jump if hex
231:       mov    bx, 2        ; Preset base to 2 (binary)
232:       cmp    dl, 'B'       ; Is it a binary string?
233:       je     @@10         ; Jump if binary
234:       mov    bx, 10        ; Preset base to 10 (decimal)
235:       cmp    dl, 'D'       ; Is it a decimal string?
236:       jne   @@20         ; Jump if NOT decimal

```

Listing 6.3. continued

```

237: @@10:
238:     dec    si                ; Adjust si to last probable digit
239: @@20:
240:     ret                    ; Return to caller
241: ENDP    ChToBase
242: %NEWPAGE
243: ;-----
244: ; AscToNum    Convert ASCII characters to binary
245: ;-----
246: ; Note:
247: ;     Private subroutine for AscToBin. Don't call directly.
248: ; Input:
249: ;     ax = initial value (0)
250: ;     bx = number base (2=binary, 10=decimal, 16=hexadecimal)
251: ;     di = address of unsigned string (any format)
252: ;     si = address of last probable digit char in string
253: ; Output:
254: ;     cf = 0 : ax = unsigned value
255: ;     cf = 1 : bad character in string (ax is meaningless)
256: ; Registers:
257: ;     ax, cx, dx, si
258: ;-----
259: PROC    AscToNum
260:     mov    cx, 1            ; Initialize multiplier
261: @@10:
262:     cmp    si, di          ; At front of string?
263:     je     @@99            ; Exit if at front (cf=0)
264:     dec    si              ; Do next char to left
265:     mov    dl, [byte si]   ; Load char into dl
266:     call   ValCh           ; Convert dl to value in dx
267:     jc     @@99            ; Exit if error (bad char)
268:     push   cx              ; Save cx on stack
269:     xchg  ax, cx           ; ax=multiplier; cx=partial value
270:     mul   dx               ; dxax <- digit value * multiplier
271:     add   cx, ax           ; cx <- cx + ax (new partial value)
272:     pop   ax              ; Restore multiplier to ax
273:     mul   bx               ; dxax <- multiplier * base
274:     xchg  ax, cx           ; ax=partial value; cx=new multiplier
275:     jmp   @@10            ; do next digit
276: @@99:
277:     ret                    ; Return to caller
278: ENDP    AscToNum
279: %NEWPAGE
280: ;-----
281: ; AscToBin    Convert ASCII strings to binary values
282: ;-----
283: ; Input:
284: ;     di = ASCIIZ string to convert to binary
285: ;     'H' at end of string = hexadecimal
286: ;     'B' at end of string = binary
287: ;     'D' or digit at end of string = decimal
288: ;     '-' at s[0] indicates negative number
289: ;     Note: no blanks allowed in string

```

```

290: ; Output:
291: ;   cf = 1 : bad character in string (ax undefined)
292: ;   cf = 0 : ax = value of string
293: ;   Note: chars in string converted to uppercase
294: ;   Note: null strings set ax to zero
295: ; Registers:
296: ;   ax
297: ;-----
298: PROC   AscToBin
299:   push  bx           ; Save modified registers
300:   push  cx           ; (some of these are changed
301:   push  dx           ; in subroutines called by
302:   push  si           ; this procedure)
303:
304:   call  StrUpper     ; Convert string to uppercase
305:   call  StrLength    ; Set cx to Length of string at di
306:   xor   ax, ax       ; Initialize result to zero (cf=0)
307:   jcxz  @@99         ; Exit if length = 0. ax=0, cf=0
308:   mov   si, di       ; Address string at di with si
309:   add   si, cx       ; Advance si to null at end of string
310:   cmp   [byte di], '-' ; Check for minus sign
311:   pushf              ; Save result of compare
312:   jne   @@10         ; Jump if minus sign not found
313:   inc   di           ; Advance di past minus sign
314: @@10:
315:   call  ChToBase     ; Set bx=number base; si to last digit
316:   call  AscToNum     ; Convert ASCII (base bx) to number
317:   rcl   bx, 1        ; Preserve cf by shifting into bx
318:   popf              ; Restore flags from minus-sign check
319:   jne   @@20         ; Jump if minus sign was not found
320:   neg   ax           ; else form twos complement of ax
321:   dec   di           ; and restore di to head of string
322: @@20:
323:   rcr   bx, 1        ; Restore cf result from AscToNum
324: @@99:
325:   pop   si           ; Restore registers
326:   pop   dx
327:   pop   cx
328:   pop   bx
329:   ret               ; Return to caller
330: ENDP   AscToBin
331:
332:   END               ; End of module

```

Using the BINASC Module

There are eight subroutines in BINASC that you can call from your own programs. (See lines 19-21.) Two other subroutines are called by the routines in the module. The following notes describe each subroutine and list several sample program fragments. After this section are two full programs that also demonstrate how to use the routines described here.

HexDigit (24-42)

HexDigit converts a 4-bit value in register `d1` to the equivalent ASCII hex digit. You probably won't need to call this routine, although you certainly can if you find a purpose for it. Other routines in the module call HexDigit as part of their algorithms to convert longer binary values to ASCII.

ASCII digits 0 through 9 have the hexadecimal values 030h through 039h. As a result of this clever design, adding hex 30h converts any single digit to ASCII. The value 04h is 34h in ASCII, 08h is 038h, and so on. Also, to convert an ASCII digit character to its equivalent binary value is a simple matter of reversing the process, subtracting 30h.

Unfortunately, this neat plan fails to accommodate the 16 hexadecimal symbols 0-9 and A-F, requiring HexDigit to check at line 35 if `d1` is less than 10 decimal. If not, line 37 performs the conversion, changing the values 0Ah, 0Bh, 0Ch, 0Dh, 0Eh, and 0Fh into the correct ASCII character, A-F. Otherwise, the `or` instruction at line 40 inserts 30h into the value, converting the decimal digits 0-9 to ASCII.

NOTE

HexDigit assumes that the most significant four bits are 0. In other words, `d1` must be limited to the range 0 to 15 or the results will not be correct.

ValCh (44-70)

ValCh reverses what HexDigit does, converting ASCII digit characters 0-9 and A-F into equivalent binary values. Because this routine is used to convert strings in various number bases, the code checks for characters that do not belong to the specified base in `bx`. To use ValCh, assign a digit character to `d1` and the number base to `bx`—2 for binary, 10 for decimal, or 16 for hexadecimal:

```
mov  d1, 'A'    ; Character to convert
mov  bx, 16     ; Number base = hex
call ValCh      ; Convert d1 to binary in dx
```

ValCh returns the converted value in register `dx`. If a bad character is detected, flag `cf` is set to 1, in which case the value in `dx` should not be trusted. Usually, you should follow ValCh with a conditional jump that tests for this:

```
call ValCh      ; Convert char in d1 to value in dx
jc   Error      ; Jump if bad digit detected
```

The procedure uses a few methods that may not be obvious on a casual reading. Lines 57-59 check for a hex character A-F, converting these digits to the ASCII characters with values 03Ah through 03Fh. (You might call these values pseudo-hex characters.) After this step, `d1` holds either an illegal character or a value in the range 030h through 03Fh, simplifying the upcoming conversion.

The next step is to convert the value in `dx` to binary by removing `030h` (line 61). As explained in the comments to `HexDigit`, subtracting `030h` converts characters to binary. In this case, the subtraction works also for the pseudo-hex characters from the previous steps.

The instructions at lines 65–66 complete the conversion by zeroing the upper half of `dx`—using the typical 8086 `xor` method. After this, `dx` is compared to the number base in `bx`. As long as the result is less than the base, the value is within range; otherwise, the original character must have been illegal. Unfortunately, this comparison leaves error flag `cf` in the opposite state that's needed, a problem easily fixed by the `cmc` instruction at line 68, which complements the carry flag, toggling it from 1 to 0 or from 0 to 1. This is also required if the test at line 62 detects an ASCII character value not in the range `030h` through `03Fh`.

NumToASCII (72-125)

`NumToASCII` is a general-purpose binary number to ASCII converter that you can use to convert values to ASCII strings in any number base from 2 to 16. Because `NumToASCII` requires considerable effort and planning to use correctly, you might want to call other routines such as `BinToASCHex` and `BinToAscDec`, which call `NumToASCII` to perform their conversions. I'll explain these routines in a moment. You should at least study `NumToASCII`'s code, if only to understand how the programming operates.

Lines 76–85 list `NumToASCII`'s register requirements along with a few important notes. The procedure assumes that register `ax` holds the value to convert, `bx` equals the number base (as explained for `va1Ch`), `cx` equals the minimum number of digit characters to insert in the string, and `es:di` addresses a string variable large enough to hold the result. A few hints about these requirements will help you to understand the programming:

- For safety, make sure your string variable is at least 5 bytes long for hex values, 6 bytes for decimal values, and 17 bytes for binary values. These lengths ensure that the result will fit and include 1 extra byte for the all-important string terminator.
- Set `cx` to 1 if you want a zero value to be converted to '0' and not a blank string. If `cx` and the value to convert are both 0, the result is a zero-length string.
- The base in `bx` is not limited to 2, 10, and 16. You can convert binary values to octal by setting `bx` to 8, or to other bases as well. Register `bx` must be in the range 2–16.
- The usual numeric qualifying characters *b*, *d*, and *h* that end values like `0FA9Ch`, `01110010b`, and `12345d` are not inserted into the string. You must add these characters if you need them.
- `NumToASCII` can't convert negative (two's complement) values to strings. To do this, call `SBinToAscDec`, which is designed to handle signed integers.

Although longer than most subroutines in this book, `NumToASCII` uses a simple method to convert values to ASCII. The `div` instruction at line 102 repeatedly divides the subject number by the base, calling `HexDigit` to convert the remainder in `dx` to ASCII. Each of these characters is pushed onto the stack (line 104.) This action repeats until register `cx` becomes

0 at the `Loop` instruction (line 106). When this happens, the code at lines 108-110 checks whether `ax` is 0, indicating that the value has been completely converted. If `ax` is not 0, then `cx` did not specify enough digits to hold the full result, and the jump at line 110 loops back to local label `@@10:` for another division until this condition is satisfied. The result is to push onto the stack at least the minimum number of digits required to represent the converted number, or as many digits as `cx` specifies, whichever is greater.

Line 105 counts in `si` the number of divisions performed, a value checked at lines 111-112. If `si = 0`, there aren't any digits. (Both `cx` and `ax` must have been 0.) If this condition is not detected, the code at lines 113-117 pops each digit from the stack—in the reverse order that the digits were pushed—and stores the digit characters in the string variable (line 116). The final step is to insert the null terminator (line 119) before ending the procedure.

BinToAscHex (127-148)

BinToAscDec (150-166)

SBinToAscDec (168-192)

BinToAscBin (194-210)

These four routines require the same parameters; therefore, I'll describe them together. `BinToAscHex` converts 16-bit unsigned values to hexadecimal strings. `BinToAscDec` converts 16-bit unsigned values to decimal strings. `SBinToAscDec` converts 16-bit signed values in two's complement notation to decimal strings. And `BinToAscBin` converts 16-bit values to binary.

NOTE

Always be sure to allocate enough string space to hold the result of converting numbers to ASCII. Be conscious that binary values might be 16 digits long. *Remember to leave an extra byte for the null terminator.* Leave extra room to be safe. To keep your code running fast, these routines do not prevent accidentally overwriting other variables in memory.

To use one of these converters, assign to `ax` an appropriate value. Set `cx` to the minimum number of digits you want in the result—at least 1 if you need zeros to come out as "0." Set `es:di` to the address of your string variable, which may be uninitialized. For example, to load a value from memory and convert to a string, you can write:

```

DATASEG
value    dw    1234                ; A 16-bit decimal value
string   db    20 DUP (?)         ; More than enough space
CODESEG
mov ax, @data
mov ds, ax                        ; Initialize ds and es to
mov es, ax                        ; address program's data segment

```

```

mov ax, [value]           ; Get value to convert
mov cx, 1                 ; At least one digit, please
mov di, OFFSET string    ; Address the string variable
call BinToAscDec         ; Convert ax to decimal string

```

You can replace the call to `BinToAscDec` with any of the other three routines—the rest of the steps remain the same. As a reminder, this example includes the steps to initialize `ds` and `es`. `BINASC` calls routines in `STRINGS`, which requires `es` to equal `ds`.

The conversion routines are not difficult to understand. Three of the four routines are extremely simple, merely saving `bx`, setting `bx` to the appropriate base, and calling `NumToASCII` to perform the actual conversion. You can, of course, call `NumToASCII` directly if you want.

`SBinToAscDec` is more complex than the other three routines because it has to deal with possible negative values in two's complement notation. Line 181 checks for negative values by comparing `ax` with 0. If `ax` is positive (`MSD = 0`), then the procedure performs a straight conversion, identical to `BinToAscDec`. If `ax` is negative, then line 183 uses `neg` to calculate the absolute value. The next line then inserts a minus sign into the string. Line 185 increments the string pointer `di` to skip the minus sign, causing the subsequent call to `NumToASCII` to start inserting digits at this new position. Register `di` is then restored at line 189. (Line 180 pushed `di` onto the stack for this reason.)

NOTE

When calling `SBinToAscDec`, be sure to leave one extra character for the minus sign. The minimum string length is 7—that is, as long as the minimum number of digits requested in `cx` is less than or equal to 6.

ChToBase (212-241)

AscToNum (243-278)

These two routines are private to the `BINASC` module, and you'll probably find few direct uses for them. (You may want to examine the code, though.) `ChToBase` returns a value in `bx` equal to the probable number base for a string ending in `D` or `0-9` for decimal, `H` for hexadecimal, and `B` for binary. (The letters must be capitals—lowercase `d`, `h`, and `b` will not work here.) Register `si` addresses the string's null terminator on entry to `ChToBase`, and on return, `si` addresses the last probable digit character in the string. Other than these points, the code is self-explanatory.

`AscToNum` performs a raw conversion from ASCII to binary, calling `ValCh` in a loop at lines 261-275. For each character loaded at line 265 into `d1`, `ValCh` returns the equivalent value or indicates an error by setting `cf`. The code at lines 268-274 multiplies the temporary result by

the multiplier (initialized at line 260), which is in turn multiplied by the number base (line 273). Repeating these steps increases the multiplier by the power of each successive column, multiplying that result by the value of the digit character in each column until done. Most of the instructions in this section are here to perform some fancy footwork so that the correct values appear in the necessary registers at the right times. For a better understanding of how this works, execute this section in Turbo Debugger and pay close attention to the register values.

AscToBin (280-330)

Call `AscToBin` to convert strings to binary values. The string format must be ASCIIZ and may end in *d* or a digit for decimal values, *h* for hexadecimal, or *b* for binary. Set `es:di` to the address of the strings to convert. After `AscToBin` finishes, the carry flag `cf` indicates if the result in `ax` is valid (`cf = 0`) or if an illegal character was detected in the string (`cf = 1`). No blanks are allowed in the string, which is converted to uppercase. (Use `StrCopy` in `STRINGS` to copy the original string if you want to preserve it.) Zero-length strings set `ax` to 0. The following illustrates the various string formats accepted by `AscToBin`:

```

DATASEG
s1 db '12345', 0 ; Decimal string (default)
s2 db '54321d', 0 ; Decimal string ending in d
s3 db '-9876', 0 ; Negative decimal string
s4 db 'F19Ch', 0 ; Hexadecimal string
s5 db '1010b', 0 ; Binary string
CODESEG
mov di, OFFSET s1 ; Address string s1 (or s2-s5)
call AscToBin ; Convert string to value in ax
jc Error ; Jump if error, else continue

```

As you can see from these samples, hexadecimal numbers do not require a leading digit as they do in assembly language programs. Signed integer values can range from -32,768 to +32,767. Unsigned integers can range from 0 to 65,535. Unusual values in the range -65,535 to -32,769 are illegal but do not cause errors. These values and others outside the allowable ranges “wrap around” to equivalent binary values.

The procedure operates by calling `StrUpper` and `StrLength` in `STRINGS` to convert the string to uppercase and to set `cx` to the string length. If `cx` is 0, the procedure ends (see line 307) with `ax` equal to 0. If the string length is not 0, lines 308-313 check if the first character is a minus sign, saving the result of the comparison at line 310 on the stack with a `pushf` instruction. `ChToBase` (line 315) then sets `bx` to the appropriate number base by testing the end of the string for D, H, or B character. Then `AscToNum` performs the actual conversion to binary. After this, the flags from the minus-sign comparison are restored (line 318) and the value in `ax` is negated to two’s complement notation (line 320) if a minus sign had been found. Notice how this plan allows converting both unsigned and signed integer ranges with the same code—65,535 and -1 are both correctly converted to the same binary value.

Two rotate instructions demonstrate one way to preserve the carry flag, which indicates AscToBin's success or failure. Line 317 rotates bx once to the left, shifting the carry flag into bx's LSD. This must be done because the very next instruction (popf) could change cf, the result of calling AscToNum. Later at line 323, the saved carry flag is rotated back into cf with rcr—a neat trick that works, if you can spare a register.

Putting BINASC to Work

Two example programs demonstrate how you can use BINASC to convert values to strings. Listing 6.4, EQUIP.ASM, also defines a RECORD variable (line 20) to extract bit fields from a system variable that indicates the kind of equipment attached to your computer. The program uses routines from BINASC and STRIO and indirectly from STRINGS, which must be installed in MTA.LIB. Assemble and link the program with the commands:

```
tasm equip
tlink equip,,, mta
equip
```

NOTE

Type line 20 all on one line. Due to space limitations, line 20 is printed in this book as two lines. You must run this program from a DOS prompt. Because of advances in modern PCs and operating systems, EQUIP is less valuable as a utility than it was when this book's first edition was published in 1989. However, the program still serves as a useful demonstration of the BINASC module.

Listing 6.4. EQUIP.ASM.

```
1: %TITLE "Display PC Equipment Info -- by Tom Swan"
2:
3:         IDEAL
4:
5:         MODEL    small
6:         STACK    256
7:
8:
9: ;----- Equates
10:
11: EOS     EQU     0           ; End of string terminator
12: cr      EQU     13          ; ASCII carriage return
13: lf      EQU     10          ; ASCII line feed
14:
15:
16: ;----- Define byte records with fields for equipment information
17:
18: ; !! NOTE : Type the line 20 on ONE line !!
19:
```

Listing 6.4. continued

```

20: RECORD Equip printers:2, x:1, game:1, ports:3, y:1, drives:2, mode:2, ram:2, z:1,
    disk:1
21:
22:
23: ;----- Define masks for isolating individual bit fields
24:
25: ;-----
26: ; AND Mask                               Field
27: ;-----
28: maskPrinters = MASK printers
29: maskGame     = MASK game
30: maskPorts   = MASK ports
31: maskDrives  = MASK drives
32: maskMode    = MASK mode
33: maskDisk    = MASK disk
34:
35:
36:         DATASEG
37:
38: exCode      db      0
39:
40: welcome     db      cr,lf,'Equipment determination'
41:             db      cr,lf,'(C) 1995 by Tom Swan',cr,lf,lf,EOS
42:
43: strPrinters db      'Number of printers ..... ', EOS
44: strGame     db      'Game I/O port ..... ', EOS
45: strPorts    db      'Number of RS232 ports ..... ', EOS
46: strDrives   db      'Disk drives (minus 1) ..... ', EOS
47: strMode     db      'Initial video mode ..... ', EOS
48: strDisk     db      'Has disk drive (1=yes) .... ', EOS
49:
50: string      db      40 DUP (?)      ; Work string
51:
52:
53:         CODESEG
54:
55: ;----- From STRIO.OBJ and BINASC.OBJ
56:
57:         EXTRN  BinToAscDec:proc, StrWrite:proc, NewLine:proc
58:
59: Start:
60:         mov    ax, @data      ; Initialize DS to address
61:         mov    ds, ax         ; of data segment
62:         mov    es, ax         ; Make es = ds
63:
64:         mov    di, OFFSET welcome ; Address welcome message
65:         call  StrWrite         ; Display message
66:         int   11h             ; BIOS equipment determination
67:         mov    bx, ax         ; Save information in bx
68:
69:         mov    di, OFFSET strPrinters ; Address item label
70:         mov    dx, maskPrinters ; Assign AND mask
71:         mov    cl, printers ; Assign shift count
72:         call  ShowInfo        ; Display label and info
73:

```

```

74:      mov     di, OFFSET strGame      ; Next item
75:      mov     dx, maskGame
76:      mov     cl, game
77:      call    ShowInfo
78:
79:      mov     di, OFFSET strPorts     ; Next item
80:      mov     dx, maskPorts
81:      mov     cl, ports
82:      call    ShowInfo
83:
84:      mov     di, OFFSET strDrives    ; Next item
85:      mov     dx, maskDrives
86:      mov     cl, drives
87:      call    ShowInfo
88:
89:      mov     di, OFFSET strMode      ; Next item
90:      mov     dx, maskMode
91:      mov     cl, mode
92:      call    ShowInfo
93:
94:      mov     di, OFFSET strDisk      ; Next item
95:      mov     dx, maskDisk
96:      mov     cl, disk
97:      call    ShowInfo
98:
99: Exit:
100:     mov     ah, 04Ch                 ; DOS function: Exit program
101:     mov     al, [exCode]             ; Return exit code value
102:     int     21h                     ; Call DOS. Terminate program
103: %NEWPAGE
104: ;-----
105: ; ShowInfo      Display label and equipment value
106: ;-----
107: ; Input:
108: ;     bx = Equipment data from int 11h
109: ;     cl = Bit field shift count
110: ;     dx = Bit field AND-mask
111: ;     di = Address of label string
112: ; Output:
113: ;     label and data value displayed
114: ; Registers:
115: ;     ax, cx
116: ;-----
117: PROC   ShowInfo
118:     mov     ax, bx                   ; Assign equipment value to ax
119:     and     ax, dx                   ; Isolate bit field in ax
120:     shr     ax, cl                   ; Shift field far right in ax
121:     call    StrWrite                 ; Display label at di
122:     mov     di, OFFSET string       ; Address work string
123:     mov     cx, 1                    ; Request at least 1 digit
124:     call    BinToAscDec              ; Convert ax to ASCIIZ string
125:     call    StrWrite                 ; Display string
126:     call    NewLine                  ; Start a new line
127:     ret                               ; Return to caller
128: ENDP   ShowInfo
129:
130:     END     Start                    ; End of program / entry point

```

How EQUIP Works

The mask constants at lines 28-33 are used to extract each of the Equip RECORD's fields as defined at line 20. The ShowInfo subroutine at lines 104-128 does the work, using dx as the mask value. Most of the program is concerned with making calls to this routine (see lines 69-97). Line 66 calls a BIOS (Basic Input/Output System) ROM routine via interrupt 11h, which all Pcs support, to load the system configuration into register ax.

The ShowInfo subroutine calls BinToAscDec to convert the masked and shifted value in ax to a string for displaying with a call to StrWrite (line 125). Figure 6.5 shows a sample run of the program.

Figure 6.5.
Sample run of Listing 6.4,
EQUIP.ASM.

```
Equipment determination
(C) 1995 by Tom Swan

Number of printers.....1
Game I/O port.....0
Number of RS232 ports.....2
Disk drives (minus 1).....0
Initial video mode.....2
Has disk drive (1 = yes)....1
```

Programming a Number Base Converter

Putting together many of the ideas in this chapter, Listing 6.5, CONVERT.ASM, is a useful utility that you can use to convert values among binary, decimal, and hexadecimal number bases. The program demonstrates how to use many of the procedures in the BINASC module. Figure 6.6 shows a sample CONVERT session.

Figure 6.6.
Sample run of Listing 6.5,
CONVERT.ASM.

```
Convert binary, hexadecimal, decimal values
(c) 1995 by Tom Swan
Press Enter to quit.

Value to convert? 745

Binary..... : 0000001011101001
Hexadecimal..... : 02E9
Unsigned decimal... : 745
Signed decimal..... : 745

Value to convert? face

**ERROR: Illegal character in string

Value to convert? faceh

Binary..... : 1111101011001110
Hexadecimal..... : FACE
Unsigned decimal... : 64206
Signed decimal..... : -1330
```

Because most of the groundwork is done by the STRINGS, STRIO, and BINASC modules, which should be in your MTA.LIB file, the CONVERT program is mostly a series of call instructions to the appropriate subroutines. Just about every other instruction is a mov to prepare registers for these calls. As a result, you should have little trouble reading the program and, by studying the comments, understanding what each line does. Assemble, link, and run CONVERT with the commands:

```
tasm convert
tlink convert,,, mta
convert
```

Listing 6.5. CONVERT.ASM.

```
1: %TITLE "Convert binary, hex, decimals -- by Tom Swan"
2:
3:      IDEAL
4:
5:      MODEL    small
6:      STACK    256
7:
8: ;----- Equates
9:
10: EOS      EQU    0           ; End of string
11: cr       EQU    13          ; ASCII carriage return
12: lf       EQU    10          ; ASCII line feed
13: maxLen   EQU    40          ; Maximum entry string length
14:
15:
16:      DATASEG
17:
18: exCode    db      0           ; DOS error code
19:
20: welcome   db      cr,lf,'Convert binary, hexadecimal, decimal values'
21:           db      cr,lf,'(c) 1995 by Tom Swan',cr,lf
22:           db      cr,lf,'Press Enter to quit.',cr,lf,EOS
23: prompt    db      cr,lf,lf,'Value to convert? ',EOS
24: error     db      cr,lf,'**ERROR: Illegal character in string',EOS
25: binary    db      cr,lf,'Binary ..... : ',EOS
26: hex       db      cr,lf,'Hexadecimal ..... : ',EOS
27: decimal   db      cr,lf,'Unsigned decimal ... : ',EOS
28: sdecimal  db      cr,lf,'Signed decimal ..... : ',EOS
29:
30: value     dw      ?           ; Result of AscToBin
31: response  db      maxLen+1 DUP (?) ; String for user response
32:
33:
34:      CODESEG
35:
36: ;----- From STRINGS.OBJ & STRIO.OBJ
37:
38:      EXTRN  StrLength:proc, StrRead:proc
39:      EXTRN  StrWrite:proc, NewLine:proc
40:
41: ;----- From BINASC.OBJ
42:
```

Listing 6.5. continued

```

43:      EXTRN  BinToAscHex:proc, SBinToAscDec:proc, BinToAscDec:proc
44:      EXTRN  BinToAscBin:proc, AscToBin:proc
45:
46: Start:
47:      mov    ax, @data           ; Initialize DS to address
48:      mov    ds, ax             ; of data segment
49:      mov    es, ax             ; Make es = ds
50:
51:      mov    di, OFFSET welcome ; Display welcome message
52:      call   StrWrite
53:
54: ;----- Prompt for value to convert
55:
56: Again:
57:      mov    di, OFFSET prompt   ; Display prompt string
58:      call   StrWrite
59:      mov    di, OFFSET response ; Get user response
60:      mov    cx, maxLen          ; Maximum string length
61:      call   StrRead
62:      call   NewLine             ; Start new display line
63:      call   StrLength           ; Did user press Enter?
64:      jcxz   Exit                ; Exit if yes (cx=0)
65:
66: ;----- Convert entered chars to binary
67:
68:      call   AscToBin            ; Convert string to ax
69:      mov    [value], ax         ; Save result in variable
70:      jnc    Continue           ; Jump if cf is 0--no error
71:      mov    di, OFFSET error    ; Else display error message
72:      call   StrWrite
73:      jmp    Again              ; Let user try again
74:
75: ;----- Convert binary value to various string number formats
76:
77: Continue:
78:      mov    di, OFFSET binary   ; Display binary label
79:      call   StrWrite
80:      mov    ax, [value]         ; Get value to convert
81:      mov    cx, 16              ; Minimum number of digits
82:      mov    di, OFFSET response ; Use same string for result
83:      call   BinToAscBin        ; Convert to binary digits
84:      call   StrWrite           ; Display result
85:
86:      mov    di, OFFSET hex      ; Display hex label
87:      call   StrWrite
88:      mov    ax, [value]         ; Get value to convert
89:      mov    cx, 4               ; Minimum number of digits
90:      mov    di, OFFSET response ; Use same string for result
91:      call   BinToAscHex        ; Convert to hex digits
92:      call   StrWrite           ; Display result
93:

```

```

94:      mov     di, OFFSET decimal      ; Display decimal label
95:      call    StrWrite
96:      mov     ax, [value]             ; Get value to convert
97:      mov     cx, 1                   ; Minimum number of digits
98:      mov     di, OFFSET response    ; Use same string for result
99:      call    BinToAscDec            ; Convert to decimal digits
100:     call    StrWrite                ; Display result
101:
102:     mov     di, OFFSET sdecimal     ; Display signed decimal label
103:     call    StrWrite
104:     mov     ax, [value]             ; Get value to convert
105:     mov     cx, 1                   ; Minimum number of digits
106:     mov     di, OFFSET response    ; Use same string for result
107:     call    SBinToAscDec           ; Convert to signed decimal
108:     call    StrWrite                ; Display result
109:     jmp     Again                   ; Repeat until done
110: Exit:
111:     mov     ah, 04Ch                 ; DOS function: Exit program
112:     mov     al, [exCode]             ; Return exit code value
113:     int     21h                     ; Call DOS. Terminate program
114:
115:     END      Start                  ; End of program / entry point

```

Summary

Structures are not variables; they're schematics that you can use to create multifield variables. A structure definition begins with `STRUC` and ends with `ENDS`. Default field values in the definition can optionally be overridden in a variable of the structure's design. To refer to the fields of a structure, write the structure variable's name, a period, and the field name. String fields in Ideal mode are padded with the default characters defined in the structure definition.

Decimal is the normal radix (number base) in assembly language programs. Hex values must begin with one decimal digit and end with *h*. Binary values end with *b*. Decimal values end with nothing or *d*. You can change the radix with the `RADIX` directive.

Turbo Assembler lets you specify signed integers in the range -32,678 to 65,535, but values in the ranges -32,768 to -1 and 32,768 to 65,535 are represented identically in binary. You can declare floating-point numbers in IEEE format with the `dt` directive, although using floating-point values in assembly language is difficult. The same directive can create binary-coded-decimal (BCD) numbers, which pack two digits into single bytes for numbers up to 20 digits long. BCD numbers are useful in business calculations because they avoid round-off errors that can occur in the results of floating-point expressions.

Although assembly language lacks built-in array mechanisms, the base- and indexed-addressing modes can be used to read and write individual array elements. There are many ways to create arrays in memory and, with the `LABEL` and `REPT` directives, you can even build arrays with automatically assigned values. The goal of array indexing is to calculate the address of an individual arrayed value. This is easiest to do when array element sizes are 1 byte or a power of 2.

Unions appear to be identical to structures but are declared with the `UNION` directive. A union's fields overlay each other in the union variable, differing from a structure where fields are distinct. Combinations of structures and unions make it possible to create complex data structures in assembly language.

The `RECORD` directive declares packed bit-field bytes and words. Field names in a record are constants that represent the number of shifts required to move field values to the rightmost position in a register or variable. The `MASK` operator converts a bit-field constant to a binary mask that can be used with logical instructions such as `and` and `or` to extract and combine bit-field values.

To automatically generate the most efficient logical `or`, `and`, `test`, and `xor` instructions, you can instead use these pseudo instructions respectively: `SETFLAG`, `MASKFLAG`, `TESTFLAG`, and `FLIPFLAG`.

If you have Turbo Assembler 3.0 or later, you can use the pseudo instructions `SETFIELD` and `GETFIELD` to insert and extract bit fields packed in records.

Turbo Assembler's predefined equates can be used, among other things, to create an automatic version stamp every time a program is assembled.

The `BINASC` module in this chapter converts signed and unsigned binary values to ASCIIZ strings and also converts ASCIIZ strings in three number bases to binary values. The routines are particularly useful for converting numeric input entered in ASCII at the keyboard into binary values for processing.

Exercises

- 6.1. Create a structure named `Time` with fields for hours, minutes, and seconds.
- 6.2. Declare `Time` variables with predefined 24-hour-clock values for 10:30:45, 14:00:00, 16:30, and midnight.
- 6.3. Create a variable named `theTime` of type `Time` from exercise #6.1 and write the assembly language instructions: to set the time to 15:45:12; to increment the hour; to reset the time to 00:00:00; and to copy `theTime` to a second variable `oldTime`.
- 6.4. Assume the default radix has been changed to 16. What are the decimal values of: `00001011`, `10000000b`, `1234`, `4321d`, `FACE` and `00FF`?
- 6.5. Create variables for the floating-point values 2.5, 88.999, and 0.141. Create binary-coded-decimal values for 125,000 and 1,250,500. What is the largest possible BCD value you can create?

- 6.6. Create arrays of 45 two-byte words; 100 four-byte (doubleword) values; 1024 bytes; and 75 binary-coded-decimal values. How many bytes do each of your arrays occupy in memory?
- 6.7. Create a word index variable and, using this value, write instructions to load `bx` with the address of any element for the four arrays in exercise #6.6.
- 6.8. Define a union similar to Figure 6.3's `ByteWord`, but with fields that allow accessing values as bytes, words, and doublewords. Show example instructions for accessing variables as any of the three types.
- 6.9. Design a packed record named `inventory` with four bit fields (width in bits shown in parentheses): `location` (3), `status` (1), `quantity` (5), and `vendor` (4). How many bytes does a variable with this design occupy in memory? What are the range of values each field can represent?
- 6.10. Write instructions to perform these operations on your `inventory` record from question #9: create a variable named `inv` of type `inventory`, set `location` to 3, set `status` to 1, add 6 to `quantity`, load `vendor` field into `dh`, toggle the `status` field, and zero all fields in the record. Hint: Use the `MASK` operator to create and masks.
- 6.11. Write a program `ADDHEX.ASM` to display the sum of two hexadecimal values entered at the keyboard. Use routines as needed from the `BINASC`, `STRINGS`, and `STRIO` modules in your answer.
- 6.12. Add an automatic version stamp to your answer in exercise #6.11.

Projects

- 6.1. Write routines to pack and unpack BCD numbers, converting a standard `dt` 2-digit-per-byte format to a 20-byte variable containing 1 digit per byte.
- 6.2. Write a logical calculator to display the results of performing `AND`, `OR`, `XOR`, `NOT`, `NEG`, `SHL`, and `SHR` operations on binary values. Users should be able to enter values and instructions at the keyboard.
- 6.3. [Advanced] Write a new version of `BINASC` named `BINASC32` to handle 32-bit decimal integers.
- 6.4. Write a program to create an array of string records. Then write subroutines to let people enter and display field values in each record. (Note: Don't be concerned with saving your data on disk, a subject covered in Chapter 9.)
- 6.5. Construct general-purpose subroutines to pack and unpack bit fields in record variable words. Your code should work with both word and byte values.
- 6.6. Write a general-purpose array index address calculator that returns the offset address for any array value of any byte size.

7

CHAPTER

Input and Output

- Standard Input and Output, 248
- Writing DOS Filters, 258
- Printing Text, 265
- Memory-Mapped Video, 267
- Memory-Mapped Video Module, 272
- A Module for Keyboard Control, 289
- Summary, 296
- Exercises, 296
- Projects, 297

Standard Input and Output

If you want your programs to run on as many different DOS systems as possible, not only IBM PCs, you must use standard methods for reading input from the keyboard and for writing output to the display—not to mention communicating with other devices such as printers and plotters.

DOS provides several standard I/O functions, the simplest of which read and write one character at a time. For example, you can read a character from the standard input device into register `al` with two simple instructions:

```
mov ah, 1      ; Specify DOS "Character Input" function
int 21h       ; Call DOS. Character returned in al
```

If the standard output device is the main console, as it usually is, reading input this way echoes each key press to the display. Because DOS I/O is redirectable, however, there's no guarantee that the input data will come from the keyboard. Unknown to the program, the person using the computer may have executed a command to tell DOS to change the standard input file from the keyboard to a disk file:

```
program <infile.txt
```

The advantage of using DOS functions to read data from the standard input file is that your program does not have to perform any special actions to permit someone changing from where input comes or to where output goes. For most purposes, the program is blissfully unaware of physical I/O device details. If someone wants to print a program's output instead of seeing it on screen, that's fine with DOS and the program. Similarly, to write a single character to the standard output device takes only a few simple commands:

```
mov ah, 2      ; Specify DOS "character Output" function
mov dl, [thechar] ; Move character into dl
int 21h       ; Call DOS
```

The character for output is loaded into `dl` from a byte variable `theChar` (not shown). Once again, because output for DOS function 2 may be redirected, there's no guarantee that this code will write a character to the display. For example, someone could execute a command such as the following to send your program's output to a serial output port, which might be attached to any sort of device.

```
program >com1
```

Taking a Break

DOS functions 1 and 2 check whether Ctrl-C—the break command—was typed some time earlier. If so, DOS executes interrupt 23h, which halts the program. (Chapter 10 explains interrupts in more detail. As used here, an interrupt is similar to a subroutine `call`.) To avoid unexpectedly breaking out of a program when someone presses Ctrl-C, you have three choices:

- Use a different DOS function
- Replace the code for interrupt 23h with your own Ctrl-C handler
- Tell the device driver to ignore Ctrl-C key presses.

Usually, the first choice is the best—other input methods are available that pass Ctrl-C back to your program just like any other key press. Writing your own interrupt handler is probably more work than necessary. The third choice takes more work (as I'll explain later in this section) but may be useful in some cases. A *device driver* is a program in a highly specialized form that interfaces with physical devices such as keyboards, printers, and displays. Many good DOS programming references explain this form.

Always remember that both of the standard input *and output* character functions 1 and 2 check for Ctrl-C key presses. When this happens due to a call to the DOS input function 1, your program never receives the Ctrl-C. When a Ctrl-C is detected during a call to DOS output function 2, the character in `d1` is passed to the standard output file *before* the Ctrl-C check takes place.

These checks for special characters are called *filters* because of the way they filter out certain key presses and characters for special action. In addition to filtering Ctrl-C, input and output functions 1 and 2 also filter other control codes, performing the actions listed in Table 7.1. Except for Ctrl-C, Ctrl-P, and Ctrl-S, which apply only to output, these actions occur for both input and output functions 1 and 2.

Unfiltered Input

When you don't want to filter Ctrl-C and other control codes, you can use one of two functions:

- DOS function 6: Direct console I/O
- DOS function 7: Unfiltered input without echo

Function 6 is included in DOS mostly to accommodate programs converted from CP/M, which has a similar function for direct console I/O. Because there are other, and probably better, ways to access input and output devices directly in DOS, there's rarely any good reason to use function 6. Instead, it's usually best to employ function 7 to read characters quietly—that is, without echoing key presses to the standard output device and without filtering Ctrl-C. Except for the function number, the code is identical to the code for function 1:

```
mov ah, 7          ; Specify DOS "Input without echo"
int 21h           ; Call DOS. Character returned in al
```

This method does not check for Ctrl-C or Ctrl-Break key presses and, therefore, prevents people from ending programs prematurely. Other control codes in Table 7.1 are returned to your program as normal key presses. To add filtering to input without echoing characters to the standard output device, use function 8, which generates the interrupt 23h break signal to end the program if DOS detects a Ctrl-C or Ctrl-Break key press. Except for this action, function 8 is identical to function 7.

Table 7.1. Standard I/O Control Codes.

<i>Ctrl Key</i>	<i>ASCII Code</i>	<i>Action</i>
Ctrl-C	03	Generate interrupt 23h (break)
Ctrl-G	07	Ring the bell
Ctrl-H	08	Nondestructive backspace
Ctrl-I	09	Tab forward
Ctrl-J	10	Line feed (with possible scroll)
Ctrl-M	13	Carriage return
Ctrl-P	16	Toggle PRN device on/off
Ctrl-S	19	Stop output until next key press

Unfiltered Output

As explained earlier, you can write ASCII\$ strings with DOS function 9. Besides requiring the strange ASCII\$ dollar-sign string format, function 9 (as function 2) detects Ctrl-C and responds to the other control codes in Table 7.1. If you must use these functions, prevent people from breaking out of a running program by calling DOS function 44h, “Device-driver control” or IOCTL—available beginning with DOS version 2. This function lets you reprogram the output device driver to ignore Ctrl-C and Ctrl-Break key presses. First, call function 44h with *al* equal to 0, reading the current device control bits from the device driver:

```
mov ax, 4400h ; DOS function 44h, item 00: get device info
mov bx, 1    ; Specify standard output
int 21h     ; Call DOS. Returns data in dx
```

The device driver’s bit settings are now in register *dx*. Bit 5 of the device driver settings tells the driver whether to process all data (bit = 1), or whether to filter characters for Ctrl-C and Ctrl-Break (bit = 0). Setting bit 5 turns off filtering:

```
mov ax, 4401h ; DOS function 44h, item 01: set device info
xor dh, dh   ; dh must be 0 for this function call
or d1, 20h   ; Set bit 5--process binary data
int 21h     ; Call DOS with data in dx
```

This technique disables Ctrl-C, Ctrl-S, and Ctrl-P filtering, not only for your program but also for any other programs including DOS itself that call functions 2 and 9 to pass data to the standard output device. For instance, after reprogramming the device driver, you will not be able to press Ctrl-C to interrupt a long directory started with the DIR command. So, as the video stores say, “Be kind: Rewind”—that is, before your program ends, clear bit 5 with the identical seven previous instructions but replace `or d1, 20h` with `and d1, 0DFh` to restore Ctrl-C checking.

Waiting Around—and Around

A program that reads input via DOS functions 1, 7, and 8 can become trapped in an endless cycle, waiting for key presses until the cows come home. (As far as I can tell, they always do. But, never mind.) Many times, you'll want a program to respond to key presses when they occur but to continue other operations if no input is ready. For example, a word processor could perform a lengthy search-and-replace operation, ending early if you press the Esc key. Or a simulation could update the display, taking various actions in real time as you type commands. There are two ways to achieve these goals:

- Interrupt-driven, buffered input
- Polling

In the first method, incoming data forces the CPU to execute special code designed to store input in memory buffers for later processing. (Chapter 11 explains this method in detail.) In the second method, a program periodically polls the input device, reading input only after detecting waiting data. If no input is available, the program continues with other operations.

With polling, you must read input often enough to avoid losing characters. For example, if someone presses two keys before you check the keyboard for new input, the first key press might be lost. Fortunately, routines in the IBM PC's ROM BIOS automatically respond to key presses, storing ASCII codes in a *type-ahead buffer*. When DOS reads data from the keyboard, it actually removes characters from this buffer. As a result, the only danger is that the buffer can fill before the program requests input. Even this danger is minimized by an automatic bell that sounds, warning a speedy typist to slow down.

NOTE

Remember that the type-ahead buffer stores only keyboard input. When input and output are redirected to other devices, characters are probably not buffered, and you must poll the input device often enough to avoid losing data. This is an especially exasperating problem with serial I/O, which DOS calls *auxiliary I/O*. When communicating with a remote computer, perhaps via modem, your program will almost certainly lose incoming data if it does not check for new input often enough. Even the time required for a simple disk write can cause several characters to slip by unnoticed. Consequently, it's best to use other methods for serial I/O on DOS systems and especially on IBM PCs, as explained in Chapter 11's discussion of interrupt processing.

Key Press Checking

To check whether incoming data is waiting to be read, use DOS function 11, “Get Input Status,” which returns `al` equal to 0 if no input data is ready or to 0FFFh if a character is waiting to be read. (Zero and 0ffh are the only two values returned by function 11; therefore, just checking whether `al` equals 0 is adequate.) With this method, you can write a simple loop to call a subroutine repeatedly, processing new characters only as they become available:

```

@@10:
  call OtherStuff      ; Code to execute until char is ready
  mov  ah, 11          ; DOS function "Get Input Status"
  int  21h             ; Call DOS. Result in al
  or   al, al         ; Is al = 0?
  je   @@10           ; Jump if al = 0. No input is waiting
  mov  ah, 7          ; Else read character with no echo
  int  21h             ; Call DOS. Character returned in al
  call ProcessChar    ; Process new input data in al
  jmp  @@10           ; Play it again, Sam

```

This fragment repeatedly calls `OtherStuff` (not shown) until function 11 indicates that a character is ready. When a new character becomes available—probably as a result of somebody pressing a key—function 7 reads the character. It then calls `ProcessChar` (also not shown) to take appropriate actions, which might include ending the program on detecting the Esc or another key. In fact, this simple example could be used as the entire “main loop” of any program that needs to continue processing while responding to key presses as they become available. Unfortunately, there’s a fly in the ointment: Function 11 also detects Ctrl+C and Ctrl+Break, ending the program via interrupt 23h if those keys are pressed. This effectively destroys the advantage of using function 7 to read unfiltered input. Even reprogramming the device driver as described earlier is of no help this time.

The answer is to call BIOS routine 16h instead of DOS to test whether a key press is available. When `ah` equals 1, this routine returns the zero flag `zf` equal to 1 if the type-ahead buffer is empty or to 0 if at least one character is in the buffer. In addition, if a character is waiting to be read, the BIOS routine returns the character in `al` and its scan code (keyboard key number) in `ah`. When `ah` initially equals 0, the same function removes and returns in `ax` one character from the type-ahead buffer. These routines give you the means to program completely unfiltered, quiet I/O. The previous code now becomes:

```

@@10:
  call OtherStuff      ; Code to execute until char is ready
  mov  ah, 1          ; Select "Input Status" routine
  int  16h            ; Call BIOS keyboard I/O function
  jz   @@10           ; Jump if zf = 1. No input is waiting
  xor  ah, ah         ; Select "Read Character" routine
  int  16h            ; Call BIOS Keyboard I/O function
  call ProcessChar    ; Process new input data in al
  jmp  @@10           ; Once more, from the top

```

With this technique, no sequence of key presses can end the program prematurely. Having solved the problem for input, another BIOS function also lets you display characters with no

Ctrl-C or Ctrl-Break filtering. With this function, you can program a procedure `ProcessChar` to display characters read by the previous sample code:

```
PROC ProcessChar
  cmp  al, 27      ; Is al = Escape key?
  je   Exit       ; If yes, exit program
  mov  bl, 15     ; Foreground color for graphics displays
  mov  ah, 14     ; Select "Write TTY" routine
  int  10h       ; Call BIOS Video I/O function
  ret           ; Return to caller
ENDP ProcessChar
```

First, `al` is compared with the ASCII code for Esc (27), jumping to the `Exit` label (not shown) if you press the Esc key. (Providing a way to end the program is essential when not relying on DOS to end the program upon sensing Ctrl-C or Ctrl-Break.) If Esc is not detected, `bl` is assigned a foreground color, required only for graphics displays. Then `ah` is set to 14 decimal, selecting the BIOS "Write TTY" routine—so called because its simple character output resembles that of a Teletype machine, in other words, lacking facilities for positioning the cursor, changing character colors and attributes, clearing to ends of lines, and so on. Still, interrupt 10h is useful for reasonably fast output, especially when you want the program to have total control over I/O.

NOTE

The BIOS Write TTY routine of interrupt 10h filters Ctrl-G (bell), Ctrl-H (backspace), Ctrl-J (line feed), and Ctrl-M as described in Table 7.1. Other control codes in Table 7.1 are displayed as graphics characters.

As with most good things in life, you pay a price by calling the ROM BIOS I/O routines. As you can see from the last several samples, the program has eliminated all calls to DOS. Consequently, the program will now run only on IBM PCs and 100% compatibles that contain the proper ROM BIOS routines. The code may not execute on plain DOS systems or under other operating systems that run pseudo-versions of DOS. Because there are so many millions of PCs installed in offices throughout the world, this may not be as severe a problem as it has been in times past. However, when using these techniques, you should at least include a warning along with your program not to attempt execution on noncompatible systems.

A more nagging problem is the loss of I/O redirection, one of DOS's most appealing goodies. Calling BIOS routines to give programs total control over character I/O means that your program users will no longer be able to redirect input to come from a text file or to send output to the printer. Many programmers consider such loss an advantage, giving their programs complete control over what is printed, what appears on display, and so forth. But, for small programs and utilities, I/O redirection is a helpful feature to have, and you may want to consider using standard DOS function calls in such cases.

Reading Function Keys

The ASCII character set directly represents only 32 control codes with values from 0 to 31, 95 symbols with values from 32 to 126, plus a delete character with the value 127 (alias, *rubout*). Including uppercase and lowercase letters, punctuation and various Ctrl, Shift, and Alt combinations, there simply aren't enough codes to cover all the key combinations offered by even a small 83- or 84-key PC keyboard.

NOTE

Although the PC extends the usual set of 128 ASCII codes with values ranging from 128 to 255, these values are reserved for graphics characters, which you can use to draw boxes, display mathematical symbols, Greek letters, and arrows, among other symbols. Enter these codes by pressing and holding the Alt-key, and then typing on the numeric keypad the ASCII value of the symbol you want.

To handle the special keys, the DOS input methods discussed in the previous section return two codes representing a function key. The first code, always 0, is called the *lead-in character*. When any keyboard input routine returns a 0, the next character indicates which function key was pressed. This scheme leads to code such as:

```
mov ah, 1          ; Specify DOS "Character Input" function
int 21h           ; Call DOS. Character returned in al
or al, al         ; Check for lead-in from keyboard
jnz NormalChar   ; Jump to process a normal character
int 21h           ; Call DOS for next character
jnz FunctionKey  ; Jump to process a function key
```

As this shows, two DOS calls to function 1 are required to detect and read function keys, including special keys such as Ins, Del, PgUp, PgDn, the cursor keys, and the numbered function keys F1–F10 found on all PC keyboards. Normal characters are processed by jumping to `NormalChar` (not shown); function keys by jumping to `FunctionKey` (also not shown).

NOTE

The previous sample sets `ah` to 1 for only the first call to DOS with `int 21h`. There's no need to set `ah` to 1 a second time because DOS preserves all registers except those specifically returned by various functions; therefore, it's safe to assume that unused registers remain unchanged between calls to DOS. When using this trick, take care that you don't inadvertently change the function number in `ah`, or disaster is sure to strike.

Many programmers use the double-DOS-call method, but I find this to be cumbersome in practice. Even though you can detect function keys, there's still no simple way to represent

these keys as plain characters, as you can other keys like A and Q. For this reason, I *map* (that is, translate) function key values to single codes, a method described later in this chapter along with the listing for a keyboard input module you can add to your library.

Flushing the Type-Ahead Buffer

When prompting for a yes or no response to a dangerous operation—formatting a disk or erasing an important disk file—it's a good idea to flush (empty) the type-ahead buffer before reading the keyboard, thereby forcing people to consider carefully their answers to your program's more serious questions. These are two ways to flush the type-ahead buffer. The first is rather obvious—simply keep reading and throwing away key presses until none is available:

```
@@10:
mov ah, 1      ; Select "Input Status" routine
int 16h       ; Call BIOS keyboard I/O function
jz  @@20      ; Jump if zf = 1. No input is waiting
xor ah, ah    ; Select "Read Character" routine
int 16h       ; Read and throw away one character
jmp @@10      ; Jump to repeat loop
@@20:         ; Type-ahead buffer is now empty
```

This code is similar to previous samples, calling BIOS interrupt 16h with ah equal to 1 to test whether input is available. If there is (as indicated by zf = 0), ah is set to 0, and interrupt 16h is again called to read one character from the type-ahead buffer, repeating these steps until no more characters are available.

NOTE

You can also call one of the DOS character input functions, numbers 7 or 8 usually, to flush the type-ahead buffer. Be aware that this doesn't work if input has been redirected.

Another possibility is to call a special DOS function that clears the type-ahead buffer and then executes another character-input command. If your program must run on all DOS systems, this is the method to use. First, load ah with the function number 0Ch. Then load the number of another input command into al: either 1, 6, 7, 8, or 0Ah. If using 0Ah, the "Get String" command, also set ds:dx to the address of the buffer to use for string input. Call DOS with int 21h, which flushes the type-ahead buffer and then executes the function specified in al. For example:

```
mov ah, 0Ch    ; Select "Reset input buffer & execute"
mov al, 7     ; 1, 6, 7, 8, or 0Ah allowed
int 21h       ; Call DOS to flush buffer and
              ; execute the command in al
```

Some assembly language programmers employ yet another technique to empty the type-ahead buffer, fiddling with two pointers (addresses) that keep track of the buffer's head and tail.

These pointers address the beginning (head) and end (tail) of the type-ahead buffer somewhere in memory. A third pointer locates the start of the buffer. By definition, when the head and tail pointers are equal, the buffer is empty. All three pointers are located in the BIOS data segment at 0040h, an area reserved for system variables. As the following fragment demonstrates, you can use this information to empty the type-ahead buffer by setting the head and tail pointers equal to the buffer's starting address:

```
bufferStart EQU 0080h ; Buffer-start pointer
head        EQU 001Ah ; Head pointer
tail        EQU 001Ch ; Tail pointer

mov ax, 0040h ; Address BIOS data segment
mov ds, ax   ; with ds register
mov ax, [bufferStart] ; Get buffer starting address
cli         ; Prevent interrupts from occurring
mov [head], ax ; Assign address to head pointer
mov [tail], ax ; Head = tail, emptying the buffer
sti        ; Allow interrupts again
```

First, segment register `ds` is set to the BIOS data segment beginning at 0040h. Then `ax` is loaded with the value stored at `[bufferStart]`, which holds the offset address of the type-ahead buffer. Inserting this value into both the head and tail pointers empties the buffer. The `cli` (clear interrupt) instruction prevents a keyboard interrupt from occurring during the time that the two pointers are being adjusted. The `sti` instruction again allows interrupts after the buffer is cleared.

NOTE

The “keyboard interrupt” referred to here is known as a *hardware interrupt*. Every time you press a key, this interrupt causes a routine in the ROM BIOS to run, reading and storing key presses in the type-ahead buffer, as previously explained. This action can happen at just about any time, independently of whatever other code is running. Because of this, interrupts are temporarily disabled while clearing the type-ahead buffer to prevent the unlikely but possible event of your pressing a key before the erasure is completed.

Introducing DOS Handles

Another useful way to move data in and out of programs is to read and write files, identified by values called *handles*. The word “file” refers to disk files, as well as to devices such as the display, keyboard and printer. Instead of writing code to access such different devices directly, you can instead read from and write to logical files assigned to the devices, employing

a single set of DOS function calls to communicate with a wide variety of hardware. (We'll return to the subject of handles in Chapter 9, which covers how to use handles to read and write disk files.)

When DOS loads and runs a program, it initializes several standard files. Table 7.2 lists the five handles associated with these files, showing the values that assembly language programs can use to communicate with the display, keyboard, printer, and one serial I/O channel.

When you issue a DOS command to redirect I/O, using the redirection character < to specify a new input device or file and > to specify a new output device or file, DOS closes handles 0 and 1 and then reopens these defaults to the new devices, thus switching I/O away from the usual CON device, that is, the display and keyboard. This happens before your program begins running; therefore, all you have to do is read from handle 0 and write to handle 1 to give people complete control over your program's I/O.

Handle 2 is most often used for displaying error messages. Because I/O redirection affects only handles 0 and 1 and because handle 2 normally refers to the console, when redirecting output to another device, writing to handle 2 still goes to the display. This lets you display progress and error messages without worrying whether the messages will interfere with other output. (You can write anything you want to handle 2; you don't have to use this handle for only error messages.)

Handle 3 is assigned to the first serial port, also known as COM1. But, because DOS handles serial I/O so poorly, you should probably not try to use this handle for communicating with remote systems via modems and high-speed RS-232 interfaces.

Handle 4 is associated with the printer, which may be plugged into the computer's parallel or serial ports. Some assembly language programmers use the ROM BIOS printer routine, interrupt 17h, which works only for parallel printers. While this is the normal configuration for most PC systems, many installations still have serial printers. Writing to the standard print device is the best way to accommodate all possible printer setups.

Table 7.2. Standard DOS Handles.

<i>Handle</i>	<i>Device Name</i>	<i>Device Description</i>
0	CON	Standard input device
1	CON	Standard output device
2	CON	Standard error output device
3	AUX	Auxiliary (serial I/O) device
4	PRN	Standard listing device (printer)

Writing DOS Filters

Using standard DOS I/O file-handling techniques, you can write *filter programs* that read the standard input file, perform some operation on incoming data, and then write the modified data to the standard output file. Multiple filter programs can be combined with a special character called a *pipe*, represented by a vertical bar (|). A pipe routes the output of one filter to the input of the next filter, which can route its output to a third filter, and so on. Combining multiple filters, each with a simple purpose—for instance, sorting text lines and extracting data based on various criteria—lets you build complex on-the-spot commands to solve problems that might otherwise require custom programming.

Along with its other utility programs, DOS provides three standard filter programs: FIND, MORE, and SORT. (Refer to your DOS manuals for information on using these programs.) You can also add your own filters to this basic set. To help you get started, Listing 7.1, FILTER.ASM, is a shell that handles most of the low-level details involved with filter programming. FILTER is a complete filter, reading from the standard input device and writing to the standard output device. Because the program is only a shell, it doesn't perform any useful function. After the listing, I'll explain how to modify the shell to do something worthwhile. Just so you know whether you entered the program correctly, you can assemble FILTER with the command `tasm filter`.

NOTE

If you try to run FILTER without supplying input and output files, the computer will appear to "hang." Press Ctrl-Z (the DOS "end-of-file" key) and Enter to recover.

Listing 7.1. FILTER.ASM.

```

1: %TITLE "Filter Shell -- Copyright (c) 1989,1995 by Tom Swan"
2:
3:         IDEAL
4:
5:         MODEL    small
6:         STACK    256
7:
8:
9: ;----- Equates
10:
11: InputHandle    EQU    0           ; Standard input handle
12: OutputHandle   EQU    1           ; Standard output handle
13: ErrOutHandle   EQU    2           ; Standard error-out handle
14: bell           EQU    07          ; ASCII bell
15: cr             EQU    13          ; ASCII carriage return
16: lf            EQU    10          ; ASCII line feed
17: eof           EQU    26          ; DOS end-of-file char (^Z)
18:

```

```

19:
20:         DATASEG
21:
22: exCode      DB      0          ; I/O error code
23:
24:
25: ;----- Error messages
26:
27: errMsg      DB      bell, cr, lf, 'FILTER ERROR: '
28: lenErrMsg   =      $-errMsg
29:
30: codeAccess  EQU      5
31: errAccess   DB      'access denied', cr, lf
32: lenErrAccess =      $-errAccess
33:
34: codeNotOpen EQU      6
35: errNotOpen  DB      'bad handle or file not open', cr, lf
36: lenErrNotOpen =      $-errNotOpen
37:
38: codeDiskFull EQU     29
39: errDiskFull  DB      'disk full', cr, lf
40: lenErrDiskFull =      $-errDiskFull
41:
42: errGeneral   DB      'unknown cause', cr, lf ; Code = ?
43: lenErrGeneral =      $-errGeneral
44:
45:
46: ;----- Input buffer
47:
48: oneChar      DB      ?          ; Holds one input character
49:
50:
51:         CODESEG
52:
53: Start:
54:     mov     ax, @data          ; Initialize DS to address
55:     mov     ds, ax            ; of data segment
56:     mov     es, ax            ; Make es = ds (optional)
57:
58: Repeat:
59:     call    ReadChar          ; Read next character
60:     jz     Done              ; End loop if at end-of-file
61:
62: ;----- Process [oneChar] here
63:
64:     call    WriteChar         ; Write processed character
65:     jnz    Repeat            ; Repeat unless disk is full
66:     mov     [exCode], codeDiskFull ; Set error code
67:     jmp     Exit              ; and skip eof write
68: Done:
69:     mov     [oneChar], eof     ; Write end-of-file character
70:     call    WriteChar         ; to standard output. Do NOT
71:                                     ; check for disk full here!

```

continues

Listing 7.1. continued

```

72: Exit:
73:     cmp     [exCode], 0           ; Check for possible error
74:     jz      @@99                  ; Jump if no error detected
75:     call   DisplayError          ; else display error message
76: @@99:
77:     mov     ah, 04Ch              ; DOS function: Exit program
78:     mov     al, [exCode]          ; Return exit code value
79:     int    21h                   ; Call DOS. Terminate program
80:
81: %NEWPAGE
82: ;-----
83: ; ReadChar    Read one character from standard input
84: ;-----
85: ; Input:
86: ;     none
87: ; Output:
88: ;     zf = 0 : al = next input character (0..255)
89: ;     zf = 1 : no more input available
90: ; Registers:
91: ;     ax
92: ;-----
93: PROC    ReadChar
94:     push   bx                    ; Save modified registers
95:     push   cx
96:     push   dx
97:
98:     mov    ah, 03Fh              ; Read-device function number
99:     mov    bx, InputHandle       ; Specify input handle
100:    mov    cx, 1                  ; Number of chars to read
101:    mov    dx, offset oneChar    ; Store input at ds:dx
102:    int    21h                   ; Call DOS. Get input.
103:    jnc    @@10                  ; Jump if no error indicated
104:    mov    [exCode], al          ; else save error code
105:    jmp    Exit                  ; and exit program early
106: @@10:
107:    or     ax, ax                 ; Set/clear zero flag (zf)
108:
109:    pop    dx                    ; Restore registers
110:    pop    cx
111:    pop    bx
112:    ret                          ; Return to caller
113: ENDP    ReadChar
114: %NEWPAGE
115: ;-----
116: ; WriteChar   Write one character to standard output
117: ;-----
118: ; Input:
119: ;     [oneChar] = character to write
120: ; Output:
121: ;     zf = 0 : character written to standard output file
122: ;     zf = 1 : output device is full (disk output only)
123: ; Registers:
124: ;     ax
125: ;-----

```

```

126: PROC   WriteChar
127:       push   bx                ; Save modified registers
128:       push   cx
129:       push   dx
130:
131:       mov    ah, 040h           ; Write-device function number
132:       mov    bx, OutputHandle   ; Specify output handle
133:       mov    cx, 1              ; Number of chars to write
134:       mov    dx, offset oneChar ; Take input from ds:dx
135:       int    21h               ; Call DOS. Write output.
136:       jnc    @@10              ; Jump if no error detected
137:       mov    [exCode], al       ; else save error code
138:       jmp    Exit              ; and exit program early
139: @@10:
140:       or     ax, ax             ; Set/clear zero flag (zf)
141:
142:       pop    dx                ; Restore registers
143:       pop    cx
144:       pop    bx
145:       ret                     ; Return to caller
146: ENDP   WriteChar
147: %NEWPAGE
148: ;-----
149: ; DisplayError      Display error message
150: ;-----
151: ; Input:
152: ;     [exCode] = non-zero error code
153: ; Output:
154: ;     none: error message sent to standard error-output device
155: ; Registers:
156: ;     ax, bx, cx, dx
157: ;-----
158: PROC   DisplayError
159:       mov    cx, lenErrMsg      ; Length of common string
160:       mov    dx, offset errMsg  ; Address of common string
161:       call  DisplayString      ; Display first part message
162:
163:       cmp    [exCode], codeAccess ; Test for codeAccess err
164:       jne    @@10              ; Jump if not this code
165:       mov    cx, lenErrAccess   ; Set string length
166:       mov    dx, offset errAccess ; Set string address
167:       jmp    DisplayString      ; Display string
168: @@10:
169:       cmp    [exCode], codeNotOpen
170:       jne    @@20
171:       mov    cx, lenErrNotOpen  ; Set string length
172:       mov    dx, offset errNotOpen ; Set string address
173:       jmp    DisplayString      ; Display string
174: @@20:
175:       cmp    [exCode], codeDiskFull
176:       jne    @@30
177:       mov    cx, lenErrDiskFull ; Set string length
178:       mov    dx, offset errDiskFull ; Set string address
179:       jmp    DisplayString      ; Display string
180: @@30:
181:       mov    cx, lenErrGeneral  ; Other error values
182:       mov    dx, offset errGeneral
183:

```

Listing 7.1. continued

```

184: DisplayString:
185:     mov     ah, 040h           ; Write-device function number
186:     mov     bx, ErrOutHandle   ; Specify error output handle
187:     int     21h               ; Call DOS. Write output.
188:     ret                          ; Return to caller
189:
190: ENDP     DisplayError
191:
192:     END     Start             ; End of program / entry point

```

How FILTER Works

FILTER uses DOS handles to read and write characters to the standard input and output devices. The program also correctly handles error conditions—including a tricky disk-full condition that many similar programs fail to detect—and illustrates a few other goodies that you can put into operation in your own code.

The three equates at lines 11–13 are assigned the values of three standard DOS handles. (See Table 7.2.) Later on, these equates are passed to appropriate DOS functions to read and write characters. Lines 27–43 illustrate a different way to declare character strings. In place of the ASCII\$ and ASCIIZ methods described before, these strings are unterminated. The first string, `errMessage` at line 27, creates a string preceded by bell, carriage return, and line-feed control characters. Writing this string rings the bell and starts a new display line, as well as writing the visible characters, “FILTER ERROR:” Line 28 shows how to assemble a numeric equate equal to the length of the string. Here’s a similar example:

```

DATASEG
dumbJoke     db     "My Texas fleas have dogs."
LenString    =     $ - dumbJoke

```

The dollar sign (\$) is called the *location counter*. Turbo Assembler replaces \$ with the current offset address at this place in the program—in this case, relative to the data segment, although you can use this symbol in any other segment, too. Because an offset address is just a value, as is the label `dumbJoke`, subtracting `dumbJoke` from the location counter *after* the string calculates the string length. You can use the same trick with any other label to calculate structure and array sizes or even to find the number of bytes of code between two points in the code segment.

NOTE

In MASM mode, you can use either an EQU directive or an equal sign to equate symbols and expressions involving the location counter \$. In Ideal mode, you *must* use an equal sign—EQU will not work. The reason for this is that Ideal mode stores EQU assignments as text, evaluating expressions only later when you use the equated symbol. Equal-sign equates are evaluated at the declaration point. For the \$ symbol to have the correct value, therefore, the expression must be evaluated where it is declared, not later when the symbol is used!

In FILTER, the series of strings and string lengths at lines 27–43 are error messages, associated with values assigned by EQU directives. For example, `codeAccess` is the error code for the string `errAccess`, which has the length `lenErrAccess`. By the way, using similar names this way is a good technique for keeping programs organized, especially when you have more than just a few symbols to track.

Lines 58–67 perform FILTER's input and output duties, repeatedly calling two subroutines `ReadChar` and `WriteChar`, reading one character from the standard input device, and storing that character in a variable `oneChar` (line 48). At line 62, you can insert your own programming to process this character before the call to `WriteChar` at line 64 sends `oneChar` on its way to the standard output.

Lines 68–70 add an end-of-file control character, ASCII 26 (Ctrl-Z), to the end of the output file. (Some programs require this character; others do not. It's probably best to write the marker just to be safe.)

FILTER.ASM ends by first inspecting the `exCode` variable, which hasn't been used up until now. In this program, an error code may be stored in `exCode` by either `ReadChar` or `WriteChar`. In that event, a third subroutine `DisplayError` sends an appropriate message to the standard error-output device handle number 2. After this, the program ends via DOS function 04Ch, passing the `exCode` value back in `ax` (lines 77–79).

The code at lines 58–75 is carefully constructed to respond to all possible I/O errors. If `ReadChar` returns the `zf` flag set, then there is no more input to process, and line 60 jumps to the `Done` label, where the end-of-file marker is written. If `WriteChar` returns the `zf` flag set, then the output file must be a disk text file and the disk is full, a condition that DOS strangely does not report as an error. Many programs skip this all-important step of checking for a disk-full condition as at lines 64–67 here.

The rest of the FILTER shell is composed of three subroutines that you can call in your own programs. The next section describe how to do this.

Readchar (82-113)

`ReadChar` demonstrates how to read one character from the standard input device (handle 0). DOS function 03Fh, "Read from file or device," requires `bx` to hold the handle number, `cx` to hold the maximum number of characters to read, and `ds:dx` to hold a pointer to the location where DOS should store the input data. This routine returns `cf` set if an error is detected, in which case the error code (either 5 or 6) is stored in `exCode` at line 104 followed by a jump to the `Exit` label, ending the program immediately if an error occurs. The `or` instruction at line 107 sets or clears `zf`. If `ax` is 0, then no more data is available from the input file; otherwise, `ax` equals the number of characters actually read, which may be fewer than the maximum specified in `cx`.

WriteChar (115-146)

`writeChar` calls DOS function 040h, “Write to file or device,” to write one character to the standard output device (handle 1). Again, `bx` equals the handle number; `cx`, the number of characters; and `ds:dx`, the address of the data to be written. If `cf` is set on return from DOS function 040h, lines 137-138 store the error code in `ax` in variable `exCode` and jump to the `Exit` label. Line 140 sets or clears `zf` as described before.

DisplayError (148-190)

`DisplayError` demonstrates how to display error (and other) messages in filter programs, using the same DOS function (040h) used in `WriteChar`. In this case, however, `bx` is assigned the standard error-output handle at line 186, with `cx` equal to the string length and `ds:dx` addressing the string variable. Because handle 2 is used, even if the standard output is redirected, error messages are still written to the display.

Customizing FILTER

Because `FILTER` reads characters from the standard input device and writes characters to the standard output device, you can use I/O redirection characters (< and >) and a pipe (|) to execute the program. To modify the program to do something useful, first copy `FILTER.ASM` to `LC.ASM` and replace line 62 in the copy with the code in Figure 7.1.

After adding the new lines, assemble and link with the commands:

```
tasm lc
tlink lc
```

You now have a new filter program `LC` to convert text files to all lowercase. One good use for `LC` is to convert to lowercase public domain assembly language listings, many of which are in all uppercase, which I find difficult to read. Before processing your valuable files, try the program on a *copy* of any text file. If your file is named `OLDFILE.TXT`, issue the command:

```
lc <oldfile.txt >newfile.txt
```

to convert the text in `OLDFILE.TXT` to lowercase and write the result to a new file named `NEWFILE.TXT`. No changes are made to `OLDFILE.TXT`.

```

mov     al, [oneChar]    ; Load al with input char
cmp     al, 'A'         ; Test if > 'A'
jb      @@10            ; Jump if al < 'A'
cmp     al, 'Z'         ; Test if al < 'Z'
ja      @@10            ; Jump if al > 'Z'
add     al, 'a'-'A'     ; Convert A-Z to a-z
mov     [oneChar], al   ; Save converted character
@@10:
```

Figure 7.1.

Code to replace line 62 in Listing 7.1, converting the `FILTER.ASM` shell to `LC.ASM`.

NOTE

One danger with redirected I/O and filter programs is that you receive no warning that an existing file is about to be overwritten by the new output. Be careful not to erase an important file when typing the output filename after the output redirection character >. Always keep backup copies of your files!

Another way to use a filter program like LC is to pipe the output of one filter into the input of another. For example, to display a sorted disk directory in all lowercase, use the command:

```
dir|lc|sort|more
```

DIR is, of course, a DOS command; LC is the filter from this chapter; MORE is a standard DOS filter program that inserts pauses at every screenfull of lines; and SORT is another standard filter that sorts text lines. Because the display is the standard output file, there's no need to redirect output in this case. When you do want to redirect piped output, for example to print a directory in lowercase, use a command like this:

```
dir|lc >prn
```

Printing Text

The printer is just another output device; therefore, the easiest way to print text is to write to the standard list-device handle, number 4. (See Table 7.2.) For example, you can print a string with code such as this:

```
DATASEG
string  DB  'This string is printed'
LenString = $ - string
CODESEG
mov  ah, 040h      ; DOS function "Write to File or Device"
mov  bx, 4         ; Standard list device handle number
mov  cx, LenString ; Assign length of string
mov  dx, offset string ; Assign string address to ds:dx
int  21h          ; Call DOS to print string
```

After this code executes, register ax equals the number of characters printed, unless cf is set, in which case ax equals an error code, probably 5 (access denied) or 6 (bad handle or file not open). If cf is not set, it's also possible, although unlikely, for ax to be less than cx, indicating that only some of the characters were successfully printed. You can deal with this situation if you want, but for most printing jobs, it's not necessary, continuing instead with:

```
    jnc Continue      ; No error--continue
    mov [errorCode], ax ; Else store error code
    jmp Error         ; Exit program
Continue:
```

An easy way to print single characters is to use DOS function 5, which sends the character in `d1` to the standard list device associated with handle 4:

```
mov ah, 5          ; DOS printer output
mov dl, [anyChar] ; Place character in dl
int 21h           ; Call DOS to print one character
```

Both this and the previous methods ensure portability and will work with just about any printer/interface combination your program is likely to meet. As mentioned earlier, you can also print a character by calling the ROM BIOS interrupt 17h, although this method won't work with serial printers:

```
mov ah, 0          ; Select print routine of interrupt 17h
mov al, [anyChar] ; Place character in al
mov dx, 0          ; Printer number 0, 1, or 2
int 17h           ; Call ROM BIOS to print one character
```

After this code, if `ah` equals 1, then the character was not printed—probably because the printer is either off line, or, perhaps, there is no printer. Use this method only if you are sure that your program will drive a printer attached to the computer's parallel interface, and you are sure the system has an IBM-compatible BIOS.

Selecting Printer Features

All modern printers understand a variety of control codes to select various features, switch on underlines, print in bold face, and so on. To select a feature is a simple matter of “printing” the correct control-code sequence. When the printer receives such a sequence, it interprets the values as instructions instead of ASCII codes to print. For example, to switch to compressed text on most Epson-compatible printers, you can write:

```
mov ah, 5          ; DOS printer output
mov dl, 14         ; Compressed-text control code
int 21h           ; "Print" the command
```

Some commands required two or more successive codes, usually starting with an escape character (ASCII 27). Probably, the best way to handle such codes is to write a small subroutine to print one character:

```
PROC PrintChar
    mov ah, 5          ; DOS printer output
    int 21h           ; Print character
    ret               ; Return to caller
ENDP PrintChar
```

Then place the value to print in `d1` and call `PrintChar`. To turn on underlining, you can write:

```
mov dl, 27
call PrintChar
mov dl, 45
call PrintChar
mov dl, 1
call PrintChar
```

This sends the sequence 27, 45, 1, which tells the printer to begin to underline subsequent text. (Change the 1 to 0 to cancel underlining.) Table 7.3 lists a subset of the more popular control sequences understood by many printers. Consult your printer manual for other codes.

Table 7.3. Typical Printer Control Sequences.

<i>ASCII Code</i>	<i>Decimal Values</i>	<i>Action</i>
BELL	7	Ring printer's bell
HT	9	Horizontal tab (forward)
LF	10	Line feed
VT	11	Vertical tab
FF	12	Form feed
CR	13	Carriage return
SO	14	Double width text on*
SI	15	Compressed text on
DC2	18	Compressed text off
DC4	20	Double width text off
CAN	24	Clear printer buffer
ESC,-,NUL	27,45,0	Underlining off
ESC,-,SOH	27,45,1	Underlining off
ESC,E	27,69	Emphasized text on
ESC,F	27,70	Emphasized text off
ESC,W,NUL	27,87,0	Double width text off
ESC,W,SOH	27,87,1	Double width text on

*Cancelled by CR, LF, or DC4

Memory-Mapped Video

To paraphrase a well-known writer whose name is similar to mine (but ends with a big bad Wolfe instead of a beautiful Swan), assembly language programmers like to power their code to the edge of the envelope. To achieve the best possible output speed in PC programming, there's only one way to fly—write characters directly to the PC's memory-mapped video.

Although there are several different kinds of video adapters and systems available for IBM PCs and compatibles, all use one of two special memory areas that other circuits read to display text on screen. These areas, called video or *regen* buffers, begin at segment address 0B000h for monochrome and Hercules displays and at 0B800h for graphics systems, including CGA,

EGA, and VGA standards. Each word in the buffer specifies an extended ASCII character value from 0 to 255 plus a second byte that selects attributes such as bold face and underlining on monochrome systems or background and foreground colors on color monitors. Although there are many different modes and features of these display standards that you can use, when it comes to displaying text by directly writing to the video buffers, the process is relatively straightforward.

The reason for having two video buffers, by the way, is that the original IBM PC allowed both monochrome and color graphics adapters to be used simultaneously. Although most people use a single CRT and adapter card today, obviously, such dual use requires two buffers to hold screen data. The first job, then, is to discover whether the system has a monochrome or color adapter—or which of the two is active in systems with both setups. Do this by calling the ROM BIOS interrupt 10h with an equal to 15 decimal:

```

DATABSEG
vBASE    dw    ?        ; Video buffer base address
CODESEG
mov  [vBASE], 0B800h    ; Initialize default segment address
mov  ah, 15             ; ROM BIOS "Get video state" number
int  10h               ; Call BIOS video I/O service
cmp  al, 7             ; Is result monochrome?
jne  @@10              ; Jump if not monochrome
mov  [vBASE], 0B000h    ; Else change default segment address
@@10:

```

These instructions call the BIOS video routine with `int 10h` and check the result returned in `al`. If `al` is 7, this is a monochrome system (including those with the popular Hercules adapter); otherwise, the system has a graphics card of some kind. Accordingly, the word variable `vBASE` is set to the proper segment address for other routines to use.

After this step, writing a character to the display is a simple matter of poking an ASCII value and an 8-bit attribute code into a memory location, offset from the segment specified by `vBASE`. There are several ways to proceed, but the method I have found easiest to use is to load `es` with the segment address and `di` with the offset:

```

mov  es, [vBASE]      ; Address video buffer segment with es
mov  di, 0            ; Assign offset address to di

```

After this, load an ASCII value into `al` and the attribute or color value into `ah` and execute `stosw` to display the character:

```

mov  al, [anyChar]    ; Load character to display into al
mov  ah, [attribute]  ; Load attribute into ah
stosw                  ; Store ax at es:di

```

If you are going to store successive characters and attributes with this method, execute a `cld` instruction before the first `stosw` to prepare for auto-incrementing `di`. When displaying only one character, it doesn't matter whether `di` increases or decreases, so you can leave this step out.

Figure 7.2 illustrates that characters in monochrome and color video memory buffers are composed of character and attribute bytes. Figure 7.3 shows the format of a character attribute byte, which is identical for both color and monochrome adapters. Of course, you see colors only on color displays. On monochrome systems, “colors” are shown as underlines, bold face, and reversed (black on bright) video.

In the video buffer memory, character bytes are stored at even addresses; attribute bytes, at odd addresses. When reading and writing the character value and attribute together into a 16-bit register, remember that the 8086 stores word values in byte-swapped order. Consequently, assuming the value of *di* is even, executing either of the following two instructions loads the character value into *al* and the attribute into *ah*:

```
lodsw          ; al <- character; ah <- attribute
mov ax, [es:di] ; Same, but di is not changed
```

Figure 7.2.
Screen positions and video buffers.

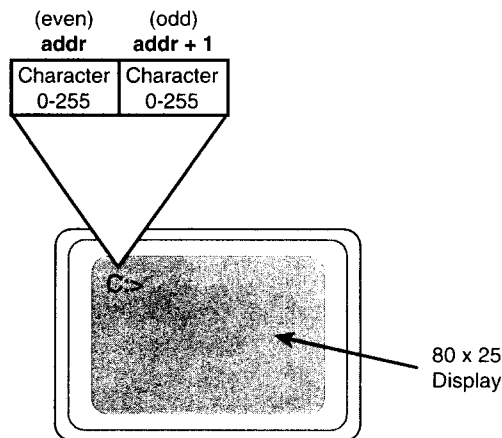
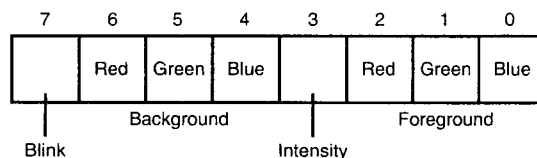

Figure 7.3.
Monochrome and color attribute byte.



Cursor Coordinates

To position the cursor to a specific location, call BIOS interrupt 10h with *ah* equal to 2, *dh* equal to the row number, and *d1* equal to the column. Location (0,0) is at the upper left corner; therefore, the maximum column is 79 and the maximum row 24 for a typical 80×25 character display. Because some video systems can display multiple pages, you must

also assign a page number to bh. Usually, you can get away with specifying the default page 0, positioning the cursor with:

```
xor bh, bh      ; Select page 0 (default)
mov ah, 2      ; Specify set-cursor routine number
mov dh, [row]  ; Load row into dh
mov dl, [column] ; Load column into dl
int 10h       ; Call BIOS video I/O service
```

If your program uses other page numbers, or if you change pages with:

```
mov ah, 5      ; Specify change-page routine number
mov al, 1      ; Specify page number 1 (second page)
int 10h       ; Call BIOS video I/O service
```

then you should request the current page number before changing the cursor location. Do this by calling interrupt 10h with an equal to 15 decimal:

```
mov ah, 15     ; Specify get-video-state routine number
int 10h       ; Call BIOS video I/O service
```

This loads the current display page number into bh, sets ah to the display width (usually 80) and, as described earlier, also sets al to the current display mode. With the page number in bh, you can then position the cursor without worrying that you may be doing this on the wrong page—an error that even some commercial programs make. (If you’ve ever used a program where the cursor sometimes disappears or behaves strangely, you’re probably seeing this problem in action.)

NOTE

If you change text display pages, be sure to switch back to page 0 before your program ends.

Snow Code

Snow is beautiful stuff, but not when it “drifts” onto a computer display. Unfortunately, by writing directly to video display memory in CGA text mode, you can introduce snow by interfering with the timing of circuits responsible for updating, or *refreshing*, the screen. (The same problem does not occur with monochrome, Hercules, and newer EGA and VGA display adapters.) This refreshing action is performed automatically about 60 times a second creating the illusion of stability when the truth is anything but.

CGA displays are rarely used on modern PCs, and dealing with this problem isn’t as necessary as it was in the past. Even so, if you want your DOS assembly language programs to work on all PCs, you must provide code for older systems. Also, the techniques described in this section are generally useful on other computer systems where similar methods for creating smooth displays may be required.

The trick in eliminating snow is to access video memory only during the time when display circuits are not likely to read data at the same addresses. The most reliable time to do this is during the *vertical retrace* period when the CRT beam moves invisibly from the bottom to the top of the display after finishing one full refresh cycle. Writing to video buffer memory during this time is guaranteed not to interfere with the CGA's own timing requirements. Detecting the vertical retrace period requires reading a register in the Motorola 6845 CRT Controller with an *in* instruction, which, along with its sister instruction *out*, have the general forms:

```
in      accumulator, port
out     port, accumulator
```

The *accumulator* may be either *al* (to input a byte) or *ax* (to input a word). The *port* specifies the physical address of the device being read and must be a number from 0 to 255 or a value in *dx* from 0 to 65,535. An *in* instruction reads a byte or word from a port. An *out* instruction writes a byte or word to a port. For some ports, simply reading or writing the correct address causes an action to occur and, in this case, the data transfer is meaningless.

To eliminate CGA snow, an *in* instruction reads the 6845 controller's status register byte at address 03dah. If bit 3 of the result in *al* is 1, then a vertical retrace operation is in progress, and it's safe to poke a character quickly into memory. The code to accomplish this is:

```
M6845 EQU 03dah      ; Address of CGA 6845 CRT Controller
mov dx, M6845        ; Set dx to input port address
@@10:
in  al, dx           ; Read 6845 status
test al, 08h         ; Test if bit 3 = 1
je  @@10             ; Repeat if bit 3 = 0
```

Immediately after this, it's safe to store a character and attribute into the video regen buffer. You can use any of the addressing methods described in this book, but the fastest way is to employ a string *stosw* instruction. Assuming that *es:di* addresses the video buffer and that *cx* holds the character in *c1* and attribute in *ch*, you can follow the previous code with:

```
mov ax, cx           ; Move character/attribute into ax
stosw                ; Store ax at es:di
```

Unfortunately, all this effort to prevent snow on CGA text screens negates most of the speed gained from writing directly to video buffers in the first place. Worse, because the program now has to check whether "snow control" is required before writing every character, output to other display types goes more slowly, too. For these reasons, you may want to consider writing two library modules, one with snow control and the other without. Also, be aware that some users are willing to put up with snow to achieve faster displays, so you should always make snow removal optional. Unfortunately, some reviewers and computer journalists have decided that snow is totally unacceptable, failing in many cases to point out that the trade-off is a severe loss of output speed. Many people welcome the extra speed even if they have to watch an occasional snowfall.

More About I/O Ports

As the previous section suggests, reading and writing ports with `in` and `out` instructions are among the lowest of low-level, hardware-specific programming jobs you can perform. Port addresses are hard-wired into computer and interface circuits, and you can't change the addresses in a program. Some interfaces allow you to select port addresses by flipping switches or installing a jumper wire. Also, it's possible to design interface cards that have programmable port addresses but, in practice, this is highly unusual. Most port addresses are fixed.

Because port addresses can differ from computer to computer, directly accessing I/O ports can limit programs to running only a specific computer model. Some addresses such as serial I/O ports (discussed in Chapter 10) are always set to one value or another. Others are added by manufacturers to control special features. For example, the following instructions switched one of my older computer systems (an ALR 386/2) between slow and fast speeds:

```
; Switch to slow speed
mov  al, 0EAh          ; Assign value to al
out  64h, al          ; Output al to port 64h
; Switch to fast speed
mov  al, 0E5h          ; Assign value to al
out  64h, al          ; Output al to port 64h
```

Undoubtedly, these same instructions will fail on a different system, so don't try them unless you're using the same computer. If you do write such hardware-dependent code, you should give users the ability to change the port address assignments, to select alternate code (perhaps to call a DOS routine for systems without a certain feature), or to bypass the hardware-specific instructions altogether.

A Memory-Mapped Video Module

Listing 7.2, `SCREEN.ASM`, includes several procedures that implement the memory-mapped video ideas in this chapter. As with `STRINGS`, `STRIO`, and `BINASC`, the program is in the form of a library module and, therefore, requires linking to a host program before running. (A full example follows this section.) There are several new techniques in `SCREEN.ASM`, described later in the section "Using the `SCREEN` Module." But all the 8086 instructions in the listing have been introduced in this and in earlier chapters, and you should have little trouble understanding most of the code. Assemble and store `SCREEN` in your `MTA.LIB` library file with the commands:

```
tasm /zi screen
tlib /E mta -+screen
```

Repeat these instructions if you later modify `SCREEN`. (As explained for other modules, ignore a possible warning that `SCREEN` is not in the library.) You can remove the `/zi` switch to reduce code-file size if you don't plan to run assembled programs in Turbo Debugger.

Listing 7.2. SCREEN.ASM.

```

1: %TITLE "Memory-Mapped Video -- Copyright (c) 1989,1995 by Tom Swan"
2:
3:
4: ;----- NOTE: You must call ScInit before calling other routines
5: ;           in this package!
6:
7:
8:     IDEAL
9:     MODEL    small
10:
11: MaxRow      EQU    25      ; Maximum number of display rows
12: MaxCol      EQU    80      ; Maximum number of display columns
13: MonoBASE    EQU    0b000h  ; Monochrome RAM segment address
14: DefaultBASE EQU    0b800h  ; Other mode RAM segment address
15:
16:
17: ;----- Character attribute byte & AND masks
18:
19: RECORD attrByte Blink:1, Background:3, Intensity:1, Foreground:3
20:
21: BlinkMask   EQU    MASK    Blink
22: BackMask    EQU    MASK    Background
23: IntensityMask EQU    MASK    Intensity
24: ForeMask    EQU    MASK    Foreground
25:
26:
27:
28:     DATASEG
29:
30: attribute   attrByte <0,0,7>      ; Attribute, default values
31: vBASE       DW    DefaultBASE      ; Video RAM buffer address
32:
33:
34: ;----- ScRow: Array of offsets (from vBASE) in video RAM buffer
35:
36: BytesPerRow = MaxCol * 2
37: row = 0
38: LABEL    ScRow    Word
39: REPT    MaxRow
40: DW ( row * BytesPerRow )
41: row = row + 1
42: ENDM
43:
44:     CODESEG
45:
46:     PUBLIC ScGotoXY, ScReadXY, ScPokeChar, ScPokeStr, ScClrRect
47:     PUBLIC ScSetBack, ScSetFore, ScBright, ScDim, ScBlink
48:     PUBLIC ScNoBlink, ScGetAttribute, ScSetAttribute, ScInit
49:

```

continues

Listing 7.2. continued

```

50: %NEWPAGE
51: ;-----
52: ; SetVidAddr   Prepare video-RAM address
53: ;-----
54: ; Note:
55: ;   Private subroutine for ScPokeChar and ScPokeStr
56: ; Input:
57: ;   dh = row (0 is top line)
58: ;   dl = column (0 is at far left)
59: ; Output:
60: ;   es:di = video RAM buffer address for (row, column)
61: ;   Note: dh and dl are not checked!!
62: ; Registers:
63: ;   bx, dx, di, es changed
64: ;-----
65: PROC   SetVidAddr
66:     mov     es, [vBASE]      ; Set es to video segment address
67:     xor     bh, bh          ; Zero upper half of bx
68:     mov     bl, dh          ; Assign row to bl
69:     shl     bx, 1           ; Multiply row (bx) times 2
70:     mov     di, [scRow+bx]  ; Set di to video buffer row address
71:     xor     dh, dh          ; Convert column to 16-bit word
72:     shl     dx, 1           ; Multiply column (dx) times 2
73:     add     di, dx          ; Add column offset to row address
74:     ret
75: ENDP   SetVidAddr
76: %NEWPAGE
77: ;-----
78: ; ScGotoXY     Set cursor position
79: ;-----
80: ; Input:
81: ;   dh = row (0 is top line)
82: ;   dl = column (0 is at far left)
83: ; Output:
84: ;   Cursor in current page repositioned to (row, column)
85: ; Registers:
86: ;   none
87: ;-----
88: PROC   ScGotoXY
89:     push    ax              ; Save modified registers
90:     push    bx
91:     mov     ah, 15          ; Get display page number into bh
92:     int     10h            ; Call BIOS video service
93:     mov     ah, 2          ; BIOS function number
94:     int     10h            ; Call BIOS--set cursor position
95:     pop     bx              ; Restore registers
96:     pop     ax
97:     ret                    ; Return to caller
98: ENDP   ScGotoXY
99: %NEWPAGE
100: ;-----
101: ; ScReadXY     Get cursor position
102: ;-----

```

```

103: ; Input:
104: ;     none
105: ; Output:
106: ;     dh = row (0 is top line)
107: ;     dl = column (0 is at far left)
108: ; Registers:
109: ;     dx changed
110: ;-----
111: PROC   ScReadXY
112:     push    ax                ; Save modified registers
113:     push    bx
114:     push    cx
115:     mov     ah, 15             ; Get display page number into bh
116:     int     10h               ; Call BIOS video service
117:     mov     ah, 3              ; BIOS function number
118:     int     10h               ; Call BIOS--get cursor position
119:     pop     cx                 ; Restore registers
120:     pop     bx
121:     pop     ax
122:     ret                    ; Return to caller
123: ENDP   ScReadXY
124: %NEWPAGE
125: ;-----
126: ; ScPokeChar   Poke a character into the display
127: ;-----
128: ; Input:
129: ;     al = ASCII character code
130: ;     dh = row (0 is top line) *
131: ;     dl = column (0 is at far left) *
132: ; Output:
133: ;     Character in al displayed at position (row, column)
134: ;     * Note: Row and Column values not checked!!
135: ; Registers:
136: ;     ax, bx, dx, di changed
137: ;-----
138: PROC   ScPokeChar
139:     push    es                ; Save es segment register
140:     call    SetVidAddr        ; Prepare es:di
141:     mov     ah, [attribute]   ; Assign attribute to ah
142:     stosw                    ; Display attribute and char
143:     pop     es                ; Restore es register
144:     ret                    ; Return to caller
145: ENDP   ScPokeChar
146: %NEWPAGE
147: ;-----
148: ; ScPokeStr    Poke a string into the display
149: ;-----
150: ; Input:
151: ;     cx = number of characters to write
152: ;     dh = row (0 is top line) *
153: ;     dl = column (0 is at far left) *
154: ;     ds:si = address of ASCII string (any format)
155: ; Output:
156: ;     * Note: Row and Column values not checked!!
157: ;     Note: Any string terminator is ignored
158: ; Registers:
159: ;     ax, bx, cx, dx, di, si changed
160: ;-----

```

Listing 7.2. continued

```

161: PROC      ScPokeStr
162:          push   es                ; Save es segment address
163:          call   SetVidAddr        ; Prepare es:di
164:          mov    ah, [attribute]    ; Assign attribute to ah
165:          cld                        ; Auto-increment si, di
166: @@10:
167:          lodsb                     ; Get next char into al
168:          stosw                      ; Display attribute and char
169:          loop   @@10              ; Loop on cx
170:          pop    es                ; Restore es segment address
171:          ret                        ; Return to caller
172: ENDP      ScPokeStr
173: %NEWPAGE
174: ;-----
175: ; ScClrRect      Clear rectangular area on display
176: ;-----
177: ; Input:
178: ;     ch, cl = row & column of upper left corner
179: ;     dh, dl = row & column of lower left corner
180: ; Output:
181: ;     Rectangle defined by ch,cl & dh,dl cleared
182: ;     to current attributes
183: ; Registers:
184: ;     ax
185: ;-----
186: PROC      ScClrRect
187:          mov    ah, 6                ; Select BIOS scroll routine
188:          mov    al, 0                ; Tells routine to clear area
189:          mov    bh, [attribute]      ; Get attribute to use
190:          int    10h                 ; Call BIOS video service
191:          ret                        ; Return to caller
192: ENDP      ScClrRect
193: %NEWPAGE
194: ;-----
195: ; ScSetBack      Set background color (attribute)
196: ;-----
197: ; Input:
198: ;     al = background color
199: ; Output:
200: ;     Background color set for ScPokeChar and ScPokeStr
201: ; Registers:
202: ;     al
203: ;-----
204: PROC      ScSetBack
205: IF Background GT 0
206:          push   cx                ; If background not in lsbs
207:          mov    cl, Background    ; then shift bits into
208:          shl   al, cl             ; position for ORing into
209:          pop    cx                ; attribute byte
210: ENDIF
211:          and    al, BackMask        ; Isolate bits in al
212:          and    [attribute], NOT BackMask ; Zero background bits
213:          or     [attribute], al    ; Add background to attribute
214:          ret                        ; Return to caller
215: ENDP      ScSetBack

```

```

216: %NEWPAGE
217: ;-----
218: ; ScSetFore      Set foreground color
219: ;-----
220: ; Input:
221: ;     al = foreground color
222: ; Output:
223: ;     Foreground color set for ScPokeChar and ScPokeStr
224: ; Registers:
225: ;     al
226: ;-----
227: PROC    ScSetFore
228: IF Foreground GT 0
229:     push    cx                ; If foreground not in lsbs
230:     mov     cl, Foreground    ; then shift bits into
231:     shl    al, cl            ; position for ORing into
232:     pop     cx                ; attribute byte
233: ENDF
234:     and    al, ForeMask      ; Isolate bits in al
235:     and    [attribute], NOT ForeMask ; Zero foreground bits
236:     or     [attribute], al   ; Add foreground to attribute
237:     ret
238: ENDP    ScSetFore
239: %NEWPAGE
240: ;-----
241: ; ScBright      Turn on intensity bit
242: ; ScDim        Turn off intensity bit
243: ; ScBlink      Turn on blink bit
244: ; ScNoBlink    Turn off blink bit
245: ;-----
246: ; Input:
247: ;     none
248: ; Output:
249: ;     Attribute's intensity & blink bits modified
250: ; Registers:
251: ;     none
252: ;-----
253: PROC    ScBright
254:     or     [attribute], IntensityMask
255:     ret
256: ENDP    ScBright
257:
258: PROC    ScDim
259:     and    [attribute], NOT IntensityMask
260:     ret
261: ENDP    ScDim
262:
263: PROC    ScBlink
264:     or     [attribute], BlinkMask
265:     ret
266: ENDP    ScBlink
267:

```

continues

Listing 7.2. continued

```

268: PROC    ScNoBlink
269:         and    [attribute], NOT BlinkMask
270:         ret
271: ENDP    ScNoBlink
272: %NEWPAGE
273: ;-----
274: ; ScGetAttribute      Get current attribute value
275: ;-----
276: ; Input:
277: ;     none
278: ; Output:
279: ;     dl = current attribute value
280: ; Registers:
281: ;     dl
282: ;-----
283: PROC    ScGetAttribute
284:         mov    dl, [attribute]      ; Get attribute byte
285:         ret                                ; Return to caller
286: ENDP    ScGetAttribute
287: %NEWPAGE
288: ;-----
289: ; ScSetAttribute      Change attribute value
290: ;-----
291: ; Input:
292: ;     al = new attribute value
293: ; Output:
294: ;     none: attribute stored for later use
295: ; Registers:
296: ;     none
297: ;-----
298: PROC    ScSetAttribute
299:         mov    [attribute], al      ; Set attribute byte
300:         ret                                ; Return to caller
301: ENDP    ScSetAttribute
302: %NEWPAGE
303: ;-----
304: ; ScInit              Initialize SCREEN package
305: ;-----
306: ; Input:
307: ;     none
308: ; Output:
309: ;     vBASE initialized
310: ; Registers:
311: ;     none
312: ;-----
313: PROC    ScInit
314:         push   ax                    ; Save modified registers
315:         push   bx
316:         mov    ah, 15                 ; BIOS function number
317:         int    10h                   ; Get video mode in al
318:         cmp    al, 7                 ; Is mode monochrome?
319:         jne    @@10                  ; If no, jump
320:         mov    [vBASE], MonoBASE     ; Assign monochrome address

```

```

321: @@10:
322:     pop    bx                ; Restore registers
323:     pop    ax
324:     ret     ; Return to caller
325: ENDP   ScInit
326:
327:     END                ; End of module

```

A SCREEN Demonstration

To give you a model program for experimenting with the new SCREEN module while you read the later procedure descriptions, here's a quick demonstration. Listing 7.3, CHARS.ASM, displays a chart of your system's video display attributes and colors. The program also shows how to combine the STRIO module from Chapter 5 with the memory-mapped video routines in SCREEN without conflict, even though both of these modules have similar subroutines. Assemble, link, and run CHARS with the commands:

```

tasm /zi chars
tlink /v chars,,, mta
chars

```

Listing 7.3. CHARS.ASM.

```

1: %TITLE "Display Character/Attribute Ref -- by Tom Swan"
2:
3:     IDEAL
4:
5:     MODEL    small
6:     STACK    256
7:
8:
9: cr     EQU    13    ; ASCII carriage return
10: lf    EQU    10    ; ASCII line feed
11: ChartRow EQU    7    ; Row for attribute chart
12:
13:
14:     DATASEG
15:
16: exCode    DB    0
17: welcome   DB    'Character attributes -- by Tom Swan',cr,lf
18:          DB    'Rows=background, Columns=foreground',cr,lf
19:          DB    'First char is dim, second char is bright',0
20: template  DB    '  00 01 02 03 04 05 06 07',cr,lf
21:          DB    '00',cr,lf,'01',cr,lf,'02',cr,lf,'03',cr,lf
22:          DB    '04',cr,lf,'05',cr,lf,'06',cr,lf,'07',0
23: blinkString DB    'This line should be blinking.', 0
24:
25:
26:     CODESEG
27:
28: ;----- From STRINGS.OBJ, STRIO.OBJ
29: EXTRN    StrLength:proc, StrWrite:proc
30:

```

Listing 7.3. continued

```

31: ;----- From SCREEN.OBJ
32:     EXTRN  ScInit:proc, ScGotoXY:proc, ScClrRect:proc
33:     EXTRN  ScPokeChar:proc, ScSetBack:proc, ScSetFore:proc
34:     EXTRN  ScPokeStr:proc, ScDim:proc, ScBright:proc
35:     EXTRN  ScBlink:proc, ScNoBlink:proc
36:
37: Start:
38:     mov    ax, @data           ; Initialize DS to address
39:     mov    ds, ax             ; of data segment
40:     mov    es, ax             ; Make es = ds
41:
42:     call   ScInit             ; Initialize SCREEN package
43:     call   Setup              ; Set up display
44:     call   Attributes         ; Display attribute chart
45:     call   Blinking          ; Display blinking chars
46:
47:     mov    dh, 23             ; Position cursor on next to
48:     mov    dl, 0              ; last display line before
49:     call   ScGotoXY          ; ending program.
50:
51: Exit:
52:     mov    ah, 04Ch           ; DOS function: Exit program
53:     mov    al, [exCode]       ; Return exit code value
54:     int    21h               ; Call DOS. Terminate program
55:
56:
57: ;----- SETUP: Initialize display
58:
59: PROC   Setup
60:     mov    ch, 0              ; Clear screen
61:     mov    cl, 0
62:     mov    dh, 24
63:     mov    dl, 79
64:     call   ScClrRect
65:     mov    dh, 1              ; Display welcome message
66:     mov    dl, 0
67:     call   ScGotoXY
68:     mov    di, offset welcome
69:     call   StrWrite
70:     mov    dh, ChartRow      ; Display chart template
71:     mov    dl, 0
72:     call   ScGotoXY
73:     mov    di, offset template
74:     call   StrWrite
75:     ret
76: ENDP   Setup
77:
78:
79: ;----- ATTRIBUTES: Display attribute chart
80:
81: UDATASEG
82: row          DB    ?          ; Uninitialized variables
83: column       DB    ?
84: background   DB    ?
85: foreground   DB    ?
86:

```

```

87: CODESEG
88: PROC   Attributes
89:       mov     [row], ChartRow       ; Initialize row
90:       mov     [background], 0      ; Initialize background
91: @@10:
92:       inc     [row]                 ; Next row
93:       mov     al, [background]     ; Set background attribute
94:       call   ScSetBack
95:       mov     [column], 1          ; Initialize column
96:       mov     [foreground], 0      ; Initialize foreground
97: @@20:
98:       add     [column], 3           ; Move to next column
99:       mov     al, [foreground]     ; Set foreground attribute
100:      call   ScSetFore
101:      call   ScDim                  ; First char is dim
102:      call   OneChar
103:      inc     [column]
104:      call   ScBright               ; Next char is bright
105:      call   OneChar
106:      inc     [foreground]         ; Repeat for all foregrounds
107:      cmp     [foreground], 7
108:      jbe    @@20
109:
110:      inc     [background]         ; Repeat for all backgrounds
111:      cmp     [background], 7
112:      jbe    @@10
113:
114:      ret
115: ENDP   Attributes
116:
117:
118: ;----- ONECHAR: Local subroutine for ATTRIBUTES
119:
120: PROC   OneChar
121:       mov     dh, [row]            ; Get row number
122:       mov     dl, [column]        ; Get column number
123:       mov     al, 'A'             ; Character to display
124:       call   ScPokeChar           ; Display char
125:       ret
126: ENDP   OneChar
127:
128:
129: ;----- BLINKING: Display blinking/non-blinking text
130:
131: PROC   Blinking
132:       mov     al, 0
133:       call   ScSetBack            ; Set background to black
134:       mov     al, 7
135:       call   ScSetFore           ; Set foreground to white
136:       call   ScBright            ; Make it whiter than white
137:       call   ScBlink             ; Turn on blinking
138:       mov     di, offset blinkString ; Address string with di
139:       call   StrLength           ; Set cx to string length
140:       mov     dh, 19              ; Assign location to dh, dl
141:       mov     dl, 0
142:       mov     si, offset blinkString ; Address string with si

```

continues

Listing 7.3. continued

```

143:      call   ScPokeStr           ; Display the string
144:      call   ScNoBlink          ; Turn off blinking
145:      ret
146: ENDP   Blinking
147:
148:      END    Start              ; End of program / entry point

```

Using the SCREEN Module

There are 14 public procedures in SCREEN plus one private subroutine used internally. You can call any of the public procedures from your own programs. This section describes how each of these routines operates and also points out interesting techniques that you can put to work in your own projects. Refer to CHARS.ASM (Listing 7.3) for real-life examples while you read these descriptions. Unless specifically noted otherwise, all line numbers here refer to those in SCREEN.ASM, Listing 7.2.

NOTE

The most important rule to remember is to call `scInit` before using any of the SCREEN routines described next. This step initializes `vBASE` to address the correct video buffer segment. If you forget to call `scInit`, your programs will not run correctly on systems with monochrome display adapters.

SetVidAddr (51-75)

`SetVidAddr` is called privately by other SCREEN procedures; therefore, you'll probably never need to use this procedure directly. The methods employed in the subroutine are applicable to a wide range of programming problems, and you may want to take time to understand how `SetVidAddr` works. The procedure takes a row and column number in `dh` and `d1` and returns `es:di` to the correct segment and offset address for the corresponding character and attributes bytes at any screen position.

Line 66 initializes `es` by loading the value of `vBASE`. Lines 67–73 then calculate the offset into the video buffer for the row and column values in `dh` and `d1`. In the interest of speed, no checks are performed on these values. As a result, if you try to write to out-of-bounds locations, you could overwrite values elsewhere in memory. Obviously, you'll want to prevent such disasters by checking `dh` and `d1` before calling SCREEN routines unless you are positive that the values are in range.

There are several well-known methods for calculating a video buffer's offset address for specific row and column screen positions. Usually, a complex formula is used, similar to the methods for locating values in arrays as described in Chapter 6. (A video buffer is, after all,

just an array of characters and attribute values.) But, there's a better way, using a data structure called *lookup table*, created at lines 36–42 and duplicated here for reference:

```
BytesPerRow = MaxCol * 2
row = 0
LABEL ScRow Word
REPT MaxRow
    dw ( row * BytesPerRow )
    row = row + 1
ENDM
```

The result of this construction is similar to the auto-initialized arrays introduced in Chapter 6, but with a few new twists. The LABEL directive assigns to label ScRow of type Word the starting address of the array. the REPT . . . ENDM section repeats for the number of times specified by MaxRow (defined at line 11). On each pass through the repeated loop, a dw directive initializes a word value equal to the row number times the number of bytes in one buffer row, using the BytesPerRow numeric equate, calculated earlier. The number of bytes in one buffer row equals the number of display columns (MaxCol) times 2—because each displayed character, as you recall, is composed of one character and one attribute byte. After each word is stored in memory, row is incremented for the next cycle.

Assembling the repeated loop creates a table of words corresponding to the offset addresses of the leftmost character on each display line—(0,0), (0,1), (0,2), ..., (0,79). SetVidAddr picks up the correct new address from this table by first multiplying the row number by 2 (lines 67–69) and then loading the address from the table into di (line 70). At this point, di addresses the row containing the character and attribute at the position specified by dh and d1. The final step is to add the column number times 2 to di, thus advancing the pointer to the exact display address for this row. Lines 71–73 accomplish this with two logical instructions (xor and shl) followed by an add. The multiplication by 2 accounts for the character and attribute bytes at each position.

By using logical instructions and a lookup table to avoid repeated calculations, SetVidAddr runs very fast. In your own programs, whenever you need to calculate values from parameters that are mostly within known ranges (as the row and column numbers are here), consider precalculating and storing the values in a lookup table instead. This can greatly increase program speed—especially for routines like SetVidAddr that will be called thousands of times during a typical program run.

ScGotoXY (77-98)

ScReadXY (100-123)

Because these two routines complement each other, it's appropriate to describe them together. ScGotoXY positions the cursor to the location specified in dh (row) and d1 (column), calling the BIOS 10h routine as described earlier in this chapter. ScReadXY returns the cursor's current location in these same registers. Both routines also set bh to the current display page number (lines 91–92 and 115–116)—an important step that many programs ignore in their cursor-positioning routines. (The page number is not returned in bh to your program.)

One way to use `ScGotoXY` is demonstrated in procedure `setUp` in `CHARS.ASM`, Listing 7.3, at lines 59–76, which position the cursor before calling `STRIO`'s `strWrite`. This works because `strWrite` calls DOS function 040h, which writes text to the current cursor position when the standard output file is the console. The same method does *not* work, however, with the output routines in `SCREEN`, which display text at locations independent of where the cursor is. Instead, you must call `ScReadXY` to find out where the cursor is and then pass this location to one of the other routines (described later) that display text:

```
call ScReadXY      ; Get cursor location
push dx           ; Save row and column
mov al, 'a'       ; Character to display
call ScPokeChar   ; Display character at (dl, dh)
pop dx           ; Restore row and column values
inc dl           ; Increment column
call ScGotoXY     ; Position cursor
```

In practice, you also have to check whether incrementing the column number in `dl` would move the cursor beyond the right screen edge, but at least this sample shows the general strategy. When adding memory-mapped video routines to your own code, remember that it's always your responsibility to control the cursor and to decide where text is to appear.

ScPokeChar (125-145)

ScPokeStr (147-172)

These two routines are short and very fast. `ScPokeChar` displays the character in `al`, which may be any extended ASCII code from 0 to 255, at the row and column specified `dh` and `dl`. If there's any chance that these values might be out of range, precede calls to `ScPokeChar` and `ScPokeStr` with code such as:

```
    cmp dh, 24      ; Is dh (row) <= 24?
    jbe @@10       ; Jump if dh <= 24
    mov dh, 24     ; Else set dh = 24
@@10:
    cmp dl, 79     ; Is dl (column) <= 79?
    jbe @@20       ; Jump if dl <= 79
    mov dl, 79     ; Else set dl = 79
@@20:
```

You can then safely call `ScPokeChar` to display a single character, without worrying that this will accidentally overwrite other memory locations. Of course, for top speed, you can leave such checks out if you are sure that row and column numbers are within range. For example, the following code places a plus sign at the end of every display row:

```
    mov dh, 24     ; Initialize dh to maximum row
    mov dl, 79     ; Initialize dl to maximum column
@@10:
    mov al, '+'    ; Character to display
    push dx       ; Save dx--changed by ScPokeChar
    call ScPokeChar ; Display one character
    pop dx        ; Restore dx
    dec dh        ; Subtract one from row number
    jns @@10      ; Jump if dh >= 0
```

Note how this code fragment decrements the row number in `dh`, looping to `@@10`: as long as the result is positive or 0. When `dh` is decremented below 0, the sign flag `sf` is set to 1, causing the `jns` instruction not to jump.

To keep these routines running fast, they do not include the snow control checking instructions described earlier. If you are using CGA text display and are having problems with snow, you may want to modify both procedures to write to the video buffer during the vertical retrace period.

Both `ScPokeChar` and `ScPokeStr` display text using the current attribute setting, which other routines in `SCREEN` can modify. (For example, see `ScSetBack` and `ScSetFore`.) The `CHARS.ASM` program offers a good example of how to display characters in all possible variations. Also, both routines call `SetVidAddr` to initialize `es:di` to the correct address in the video buffer corresponding to the requested row and column.

`ScPokeStr` displays an entire string, which may or may not be in ASCIIZ format. To use this routine, you must set `cx` to the number of characters to display, `dh` and `d1` to the row and column number where you want the first character to appear, and `ds:si` to the address of the first character in the string. If your string is in ASCIIZ format, you can call the `STRINGS` `StrLength` routine to initialize `cx` prior to calling `ScPokeStr`, as in this sample, which displays a string at the top of the display:

```

DATASEG
string  DB  'My Program. Version 1.00.', 0
CODESEG
mov  ax, @data          ; Initialize segment registers
mov  ds, ax             ; ds and es to address the program's
mov  es, ax             ; data segment
mov  di, offset string  ; Address string with di
call StrLength          ; Set cx to string Length
xor  dx, dx             ; Position at (0,0)
mov  si, di             ; Address string with si
call ScPokeStr          ; Display string

```

NOTE

Displaying text with `ScPokeChar` and `ScPokeStr` never causes the display to scroll. This means you can poke a character to the lower right corner at position (79,24) without disturbing any text on display. Also, these two routines display a symbol for every extended ASCII code from 0 to 255 including carriage returns, line feeds, bells, and other control codes.

ScClrRect (174-192)

`ScClrRect` clears a rectangle defined by registers `ch` and `c1` (top left row and column) and `dh` and `d1` (bottom right row and column). Be sure these registers are within range before calling `ScClrRect`, which does not check for out-of-bounds values. The procedure calls ROM BIOS interrupt `10h` with `ah` equal to `6` (the number of the video service routine's scroll-up command). When `a1` equals `0`, this routine clears the defined display area using the attribute specified in `bh` (see line 189).

Some programmers devise their own super-fast clear screen routines, which you certainly can do using methods described earlier for writing to the video buffer. For example, you might simply erase the entire video buffer, using a repeated `stosw` command to set every character to a blank (ASCII `20h`) and every attribute to a certain background color (`0` for black, probably). For most uses, however, the standard method used in `ScClrRect` is more than adequate.

ScSetBack (194-215)**ScSetFore (217-238)**

Use these routines to change the foreground and background attribute settings for subsequent calls to `ScPokeChar`, `ScPokeStr`, and `ScClrRect`. Call `ScSetBack` with `a1` equal to a new background color with values from `0` to `7`. Call `ScSetFore` with `a1` equal to a new foreground color with values also from `0` to `7`. Table 7.4 lists the color values for CGA, EGA, and VGA displays. (To obtain the foreground colors in the intensified column, you must call `ScBright` and `ScDim`, described next. Background colors can't be intensified.) Table 7.5 lists equivalent values and associated effects for monochrome displays. You can also call `ScBright`, `ScDim`, `ScBlink`, and `ScNoBlink` for additional variations. Also, other foreground and background values in the range `0-7` are allowed but produce the same visible effects as the values in the table.

`ScSetBack` and `ScSetFore` use the packed bit-field methods described in Chapter 5 to modify individual values in attribute bytes, defining an `attrByte` record at line 19 corresponding to Figure 7.3. Notice how the `IF/ENDIF` conditional statements at lines 205–210 and 228–233 prevent unnecessary code from being assembled if the `Foreground` or `Background` fields are already far right in the byte. In this case, because the attribute byte format is unlikely to change, the extra `IF/ENDIF` statements are probably unnecessary. Even so, the instructions demonstrate how to write routines to allow for possible changes to other less stable `RECORD` designs.

Table 7.4. Foreground and Background Color Values.

<i>Value</i>	<i>Color</i>	<i>Intensified (foreground only)</i>
0	Black	Dark gray
1	Blue	Light blue
2	Green	Light green
3	Cyan	Light cyan
4	Red	Light red
5	Magenta	Light magenta
6	Brown	Yellow
7	White	Bright white

Table 7.5. Monochrome Attribute Values.

<i>Background</i>	<i>Foreground</i>	<i>Effect</i>
0	0	No display
0	1	Underline
0	7	Normal text
7	0	Reversed text

ScBright (240-256)**ScDim (258-261)****ScBlink (263-266)****ScNoBlink (268-271)**

These four routines modify the `Blink` and `Intensity` bits in the attribute variable declared at line 30. The instructions use `and` and `or` masks to set and clear these bits, further modifying the values assigned by `ScSetFore` and `ScSetBack` for future calls to `ScPokeChar`, `ScPokeStr`, and `ScClrRect`. The names and purposes of the routines should be obvious.

NOTE

Due to hardware limitations, you can blink only foreground colors. Background colors don't blink. Also, on color displays, some "dim" colors actually appear brighter than their "intensified" partners. I find it helpful to think of "intense" colors as being mixed with white paint—rather than being "brighter."

ScGetAttribute (273-286)**ScSetAttribute (288-301)**

Instead of calling `ScSetFore`, `ScSetBack`, `ScBright`, `ScDim`, `ScBlink`, and `ScNoBlink`, you can call `ScSetAttribute` with any 8-bit attribute value. Subsequent calls to `ScPokeChar`, `ScPokeStr`, and `ScClrRect` will then use the new value for all displayed text. In most cases, this is faster than calling multiple combinations of other routines to select various color attributes. Along with `ScGetAttribute`, the routines also allow you to save and restore the current attribute at times when you want to make a temporary color change. For example, to display a flashing error message in red, you might use code such as:

```
call ScGetAttribute    ; Load current attribute into dl
push dx               ; Save value on stack
mov  al, 4            ; Assign red color to al
call ScSetFore        ; Change foreground to red
call ScBright         ; Intensify color
call ScBlink          ; Set foreground blinking
;
;-----display error message here with new attributes
;
pop  ax               ; Pop saved attribute off stack
call ScSetAttribute   ; Reset attribute to previous value
```

Another useful technique is to build attribute values by calling `ScSetFore` and `ScSetBack` (among others) and then store the result in a variable for later use. For example, you might do this in a setup utility that lets people adjust the colors of the main program:

```
DATASEG
customColor    db    0
CODESEG
mov  al, 6      ; Assign yellow color to al
call ScSetFore ; Change foreground to yellow
call ScBright  ; Intensify color
mov  al, 1      ; Assign blue color to al
call ScSetBack ; Change background to blue
call ScGetAttribute ; Get composite attribute
mov  [customColor], dl ; Save attribute for later
```

To use the attribute, all you have to do is load `[customColor]` into `al` and call `ScSetAttribute`. You don't have to repeat any of the other steps.

Scinit (303-325)

The final routine in the SCREEN module is `ScInit`, which you must remember to call at the beginning of your program before using `ScPokeChar` or `ScPokeStr` to display text. Because `vBASE` is preinitialized to the color display segment address (see line 31), if you forget to call `ScInit`, your program will not operate on systems with monochrome (including Hercules) display adapters.

A Module for Keyboard Control

Most of the time, the methods described at the beginning of this chapter provide adequate keyboard input abilities for assembly language programming. But, there are also times when standard DOS function calls are inadequate. For one, you may not want people to be able to redirect input. And, for another, DOS makes special- and function-key handling difficult by requiring two DOS-function calls to read single keystrokes.

To answer these challenges, Listing 7.4, `KEYBOARD.ASM`, contains two routines that I've found helpful. All key presses including ASCII characters, control keys, and function keys can be read with a single subroutine call. Following the listing is an example that explains how this works. Assemble `KEYBOARD` and install in the `MTA.LIB` library file with the commands:

```
tasm /zi keyboard
tlib /E mta -+keyboard
```

As always, ignore the possible warning that `KEYBOARD` is not in the library and leave out the `/zi` option to reduce code-file size if you don't plan to run host programs in Turbo Debugger.

Listing 7.4. `KEYBOARD.ASM`.

```
1: %TITLE "Keyboard Input Routines -- Copyright (c) 1989,1995 by Tom Swan"
2:
3:     IDEAL
4:
5:     MODEL    small
6:
7:
8:     CODESEG
9:
10:    PUBLIC  KeyWaiting, GetCh
11:
12: %NEWPAGE
13: ;-----
14: ; KeyWaiting    Test if a keypress is available
15: ;-----
```

continues

Listing 7.4. continued

```

16: ; Input:
17: ;     none
18: ; Output:
19: ;     zf = 0 : (JNZ) Character is waiting to be read
20: ;     zf = 1 : (JZ)  No character is waiting
21: ; Registers:
22: ;     none (flags only)
23: ;-----
24: PROC   KeyWaiting
25:     push    ax                ; Save modified register
26:     mov     ah, 1             ; BIOS check buffer function
27:     int     16h              ; Call BIOS keyboard service
28:     pop     ax                ; Restore register
29:     ret                                ; Return to caller
30: ENDP   KeyWaiting
31: %NEWPAGE
32: ;-----
33: ; GetCh      Return ASCII, Control, or Function key value
34: ;-----
35: ; Input:
36: ;     none
37: ; Output:
38: ;     zf = 0 (ah = 1) : (JNZ) al = ASCII character
39: ;     zf = 1 (ah = 0) : (JZ)  al = ASCII control or function
40: ; Registers:
41: ;     ax
42: ;-----
43: PROC   GetCh
44:     xor     ah, ah            ; BIOS read-key function
45:     int     16h              ; Call BIOS keyboard service
46:     or      al, al           ; Is ASCII code = 0?
47:     jnz    @@10             ; If no, jump (not a special key)
48:     xchg   ah, al           ; Else set ah<-0, al<-scan code
49:     add    al, 32           ; Adjust scan code to >= 32
50:     jmp    short @@20       ; Jump to exit
51: @@10:
52:     xor     ah, ah            ; Initialize ah to 0
53:     cmp    al, 32           ; Is ASCII code < 32 (i.e. a Ctrl)?
54:     jb     @@20             ; If yes, jump (al=control key)
55:     inc    ah               ; Else set ah = 1 (al=ASCII char)
56: @@20:
57:     or      ah, ah           ; Set or clear zf result flag
58:     ret                                ; Return to caller
59: ENDP   GetCh
60:
61:     END                        ; End of module

```

A KEYBOARD Demonstration

Listing 7.5, KEYS.ASM, demonstrates how to use the KEYBOARD module. When you run the program, press any key to see the key type and numeric value. (Note: You may

find that function-key values are different than in many other programs. The reason for this discrepancy is explained later.) Press Esc to end the program. Assuming you have assembled and installed the other modules in this and previous chapters, assemble, link, and run KEYS with the commands:

```
tasm /zi keys
tlink /v keys,,, mta
keys
```

Listing 7.5. KEYS.ASM.

```
1: %TITLE "Display Key Values -- Copyright (c) 1989,1995 by Tom Swan"
2:
3:     IDEAL
4:
5:     MODEL    small
6:     STACK    256
7:
8: cr    EQU    13    ; ASCII carriage return
9: lf    EQU    10    ; ASCII line feed
10:
11:
12:     DATASEG
13:
14: exCode    DB    0
15: charKey   DB    'Character key : ', 0
16: funcKey   DB    'Function key : ', 0
17: numString DB    7 DUP (0)
18: welcome   DB    cr,lf,'Display Key Values--by Tom Swan'
19:           DB    cr,lf,'Press any key, or press Esc to quit'
20:           DB    cr,lf,lf,0
21:
22:
23:     CODESEG
24:
25: ;----- From BINASC.OBJ
26: EXTRN    BinToAscDec:proc
27:
28: ;----- From STRIO.OBJ
29: EXTRN    StrWrite:proc, NewLine:proc
30:
31: ;----- From KEYBOARD.OBJ
32: EXTRN    Keywaiting:proc, Getch:proc
33:
34: Start:
35:     mov    ax, @data    ; Initialize DS to address
36:     mov    ds, ax      ; of data segment
37:     mov    es, ax      ; Make es = ds
38:
39:     mov    di, offset welcome ; Display welcome message
40:     call   StrWrite
41:
```

continues

Listing 7.5. continued

```

42: Repeat:
43:     call    KeyWaiting          ; Wait for any keypress
44:     jz      Repeat             ; Repeat until key waiting
45:     call    GetCh              ; Read keypress
46:     mov     di, offset charKey  ; Address charKey string
47:     jnz     @@10               ; Jump if key is a character
48:     cmp     al, 27             ; Was Escape key pressed?
49:     je      Exit               ; If yes, jump to exit
50:     mov     di, offset funcKey  ; Address funcKey string
51: @@10:
52:     call    StrWrite           ; Display key-type label
53:     xor     ah, ah             ; Convert al to 16 bits
54:     mov     cx, 1              ; Minimum number of digits
55:     mov     di, offset numString ; Address number string
56:     call    BinToAscDec        ; Convert number to string
57:     call    StrWrite           ; Display key value
58:     call    NewLine           ; Start new display line
59:     jmp     Repeat            ; Get next keypress
60:
61: Exit:
62:     mov     ah, 04Ch           ; DOS function: Exit program
63:     mov     al, [exCode]       ; Return exit code value
64:     int     21h               ; Call DOS. Terminate program
65:
66:     END     Start             ; End of program / entry point

```

Using the KEYBOARD Module**NOTE**

Line numbers in the following descriptions refer to those in Listing 7.4 unless otherwise noted.

KeyWaiting (13-30)

KeyWaiting returns the zf flag cleared (equal to 0) if a character is waiting to be read from the keyboard type-ahead buffer. If the zf flag is set (equal to 1), then no character is waiting. Use KeyWaiting in loops such as:

```

@@10:
    call AnyProcedure ; Code to execute while waiting
    call KeyWaiting   ; Check for a key press
    jz  @@10          ; Jump if no key was pressed
    call GetCh        ; Read character from keyboard

```

GetCh (32-59)

GetCh is my personal answer to the dilemma of reading PC function keys. The “normal” method is to call a DOS input routine twice—once to read the lead-in null character (ASCII 0) and a second time to read the function-key value. Because of this scheme, all programs must detect function keys to avoid displaying these special values as text. (You have probably seen programs that forget to do this, writing Ks and other strange letters when you press an arrow or other function key.)

With GetCh, zero flag *zf* indicates whether the value returned in *ah* is a plain ASCII character (*zf* = 0) or is a function or control key (*zf* = 1). ASCII character values range from 32 to 255. Function- and control-key values range from 0 to 255. A single call to GetCh is all you need to process any keystrokes. Table 7.6 lists the function- and control-key values returned by GetCh for *zf* = 1. Table 7.7 lists additional values for keys with normal ASCII values in the first two columns (*zf* = 0) and various Ctrl, Alt, and a few Shift+Ctrl combinations for those same keys in the other columns (*zf* = 1). Values that are not available are marked with dashes. Key combinations that return the same values as other combinations are in parentheses. All values in both tables are in decimal.

Using GetCh is easy. Just call the subroutine and then inspect the state of *zf* to distinguish between plain ASCII and function or control keys:

```
call GetCh      ; Get a character from keyboard
jz  FunctionKey ; Call routine for function/control keys
jnz ASCIIKey   ; Call routine for normal ASCII keys
```

The code in GetCh works by calling ROM BIOS interrupt 16h with *ah* equal to 0, reading the next key press, or taking a key-press value from the type-ahead buffer. The BIOS interrupt routine returns the keyboard scan code (a number representing the key’s position) in *ah* and the ASCII value in *a1*. If *a1* is 0, then *ah* represents a function key; otherwise, the key is a plain ASCII character. The code at lines 48–50 adds 32 to function-key values to prevent conflicts with control codes in the range 0–31. For this reason, the values returned by GetCh do not match similar functions in most high-level languages. Use the KEYS program along with Tables 7.6 and 7.7 to determine which keys produce which values. The other instructions in GetCh set *ah* to 1 for ASCII characters or to 0 for function and control keys. Line 57 then ORs *ah* with itself to set *zf* to 1 only if *ah* is 0.

Table 7.6. GetCh Function- and Control-Key Values.

<i>Key</i>	<i>Normal</i>	<i>+Shift</i>	<i>+Ctrl</i>	<i>+Alt</i>
F1	91	116	126	136
F2	92	117	127	137
F3	93	118	128	138

continues

Table 7.6. continued

<i>Key</i>	<i>Normal</i>	<i>+Shift</i>	<i>+Ctrl</i>	<i>+Alt</i>
F4	94	119	129	139
F5	95	120	130	140
F6	96	121	131	141
F7	97	122	132	142
F8	98	123	133	143
F9	99	124	134	144
F10	100	125	135	145
Ins	114	(114)	-	-
Del	115	(115)	-	-
Home	103	(103)	151	-
PgUp	105	(105)	164	-
PgDn	113	(113)	150	-
Up	104	(104)	-	-
Down	112	(112)	-	-
Left	107	(107)	147	-
Right	109	(109)	148	-
End	111	(111)	149	-
Esc	27	(27)	(27)	-

Table 7.7. Additional GetCh Key Values.

<i>Key</i>	<i>Normal</i>	<i>+Shift</i>	<i>+Ctrl</i>	<i>+Alt</i>
A	97	65	1	62
B	98	66	2	80
C	99	67	3	78
D	100	68	4	64
E	101	69	5	50
F	102	70	6	65
G	103	71	7	66
H	104	72	8	67
I	105	73	9	55

<i>Key</i>	<i>Normal</i>	<i>+Shift</i>	<i>+Ctrl</i>	<i>+Alt</i>
J	106	74	10	68
K	107	75	11	69
L	108	76	12	70
M	109	77	13	82
N	110	78	14	81
O	111	79	15	56
P	112	80	16	57
Q	113	81	17	48
R	114	82	18	51
S	115	83	19	63
T	116	84	20	52
U	117	85	21	54
V	118	86	22	79
W	119	87	23	49
X	120	88	24	77
Y	121	89	25	53
Z	122	90	26	76
0	48	41	-	161
1	49	33	-	152
2	0	64	35	153
3	51	35	-	154
4	52	36	-	155
5	53	37	-	156
6	54	94	30	157
7	55	38	-	158
8	56	42	-	159
9	57	40	-	160
]	93	125	29	-
[91	123	27	-
-	45	95	31	162

Summary

Standard DOS I/O methods may not be glamorous, but they allow programs to run on as wide a variety of systems as possible. One advantage of using standard DOS I/O is to give computer operators the ability to redirect input and output without the program's (or your) advance knowledge.

The type-ahead buffer fills with keystrokes independently of other program actions. Every key press causes an interrupt routine to capture the key value and store it in memory. When the keyboard is the standard input device, as it usually is, calls to DOS input functions remove key values from the type-ahead buffer. Erasing the keyboard buffer is a simple matter of resetting two pointers that mark the first and last character in the buffer.

Handles are values that refer to logical files, which provide a common interface between programs and various peripheral devices. DOS initializes five handles, which programs can use to write to the display, read the keyboard, display error messages, access a communications port, and print text. One good use for handles is to write simple filter programs that can have their input and output piped together with other filters to perform complex operations.

The dollar sign (\$) is Turbo Assembler's location counter, equal to the current address at any place in a program. This symbol is particularly useful to determine the sizes of variables, especially strings. In Ideal mode, equated expressions involving the location counter must be assigned with the equal-sign operator.

Printing text is most easily accomplished by writing to the DOS standard list device, using one of the preassigned handles. Calling the ROM BIOS to print text is not a good idea because this routine does not work with printers attached to a serial port.

There's no faster way to display text than to write characters directly to memory-mapped video buffers. The memory buffers store characters along with attribute values, which select colors and features such as underlining and reverse video on monochrome systems. Using memory-mapped video techniques on older CGA text displays can produce snow. This problem can be eliminated by synchronizing the program with the display's vertical retrace signal, but the trade-off is a serious loss of output speed.

Exercises

- 7.1. What are three DOS functions that programs can use to input single characters? Write the assembly language instructions to call these functions.
- 7.2. Write a program to read single characters from the keyboard, convert the characters to uppercase (regardless of whether the Caps Lock or Shift keys are pressed), and write the modified characters to the standard output file. Pressing Esc should end your program.

- 7.3. Write a subroutine that returns the zero flag set ($zf = 1$) if the Esc key has been pressed. The subroutine should return the zero flag cleared ($zf = 0$) if: a) there is no key press waiting to be read, or b) there is a key press waiting and the value of that key is not Esc. The subroutine should return $zf = 1$ only if a key is waiting and that key is Esc. The subroutine should not pause for input and should preserve all registers. (ASCII Esc equals 27 decimal.)
- 7.4. Revise your answer in Exercise 7.3 to return $zf = 1$ if function key F1 is pressed. Write your solution without using `GetCh` in the `KEYBOARD` module. (Hint: DOS returns a null `[0]` followed by `03Bh` for key F1.)
- 7.5. What is a handle? How are handles used? How many handles are preassigned by DOS?
- 7.6. Why are filter programs useful? Name at least one filter supplied with DOS.
- 7.7. Create an equate that automatically is assigned the length of the string "I hate meeses to pieces."
- 7.8. Write a subroutine to fill the screen with any single character passed as a parameter in register `al`. Use the `SCREEN` module in your answer.
- 7.9. Displaying the string "ERROR: Dumb mistake detected" with bright white flashing letters on a red background on color displays. Use the `SCREEN` module in your answer. (Note: On monochrome displays, a red background appears black. Under Microsoft Windows, depending on your display mode and type, flashing characters may not be available.)
- 7.10. What routine must call in the `SCREEN` module to ensure correct operation on monochrome displays?
- 7.11. Write a subroutine to return the zero flag set ($zf = 1$) if an operator presses the Y key. The zero flag should be cleared ($zf = 0$) if any other key is pressed. Preserve all registers. Use the `KEYBOARD` module in your answer.

Projects

- 7.1. Develop an object-code module with CRT terminal functions such as clear screen, clear to end of line, clear to end of screen, position cursor, and ring the bell. The module should use standard DOS function calls.
- 7.2. Write a subroutine to insert a sequence of characters (preferably an ASCII string) into the keyboard type-ahead buffer. How might you use such a routine?
- 7.3. Write a filter to convert tab control characters in a text file to blanks. Write another filter to convert blanks to tabs.

- 7.4. Write a program to select all (or most of) your printer's special print modes. Make the program easy to modify for other printer models.
- 7.5. Modify the SCREEN module to eliminate snow on CGA text displays.
- 7.6. [Advanced] Write an object-code module to scroll the display up, down, left, and right without calling BIOS routines to perform these actions.

8

CHAPTER

Macros and Conditional Assembly

- What Are Macros?, 300
- Macro Advantages and Disadvantages, 300
- Constructing Macros, 301
- Purging Macro Definitions, 301
- Parameter Substitution, 302
- Macros and Variables, 307
- Macros and Code, 310
- Conditional Compilation, 314
- Starting a DOS Macro Library, 324
- Summary, 333
- Exercises, 334
- Project, 335

- 7.4. Write a program to select all (or most of) your printer's special print modes. Make the program easy to modify for other printer models.
- 7.5. Modify the SCREEN module to eliminate snow on CGA text displays.
- 7.6. [Advanced] Write an object-code module to scroll the display up, down, left, and right without calling BIOS routines to perform these actions.

8

CHAPTER

Macros and Conditional Assembly

- What Are Macros?, 300
- Macro Advantages and Disadvantages, 300
- Constructing Macros, 301
- Purging Macro Definitions, 301
- Parameter Substitution, 302
- Macros and Variables, 307
- Macros and Code, 310
- Conditional Compilation, 314
- Starting a DOS Macro Library, 324
- Summary, 333
- Exercises, 334
- Project, 335

What Are Macros?

As you gain experience in assembly language programming, you'll undoubtedly repeat yourself many times, retyping the same instruction sequences over and over. To reduce the amount of repetition in a program, you can store one or more instructions in a named *macro definition* and then use the simpler macro name whenever you need the same code. When Turbo Assembler assembles a macro name, it replaces the name with the instruction sequence from the macro definition. In addition, you can pass parameters to macros, changing the assembled instructions to handle new requirements. With macros, you invent new commands to customize Turbo Assembler to operate according to your tastes.

In addition to a wide selection of macro operators and directives, Turbo Assembler provides a set of *conditional assembly directives* that are often used inside macro definitions. These directives let you write programs that assemble differently based on various conditions usually listed at the beginning of a module or program. For example, you can write programs that assemble special code for debugging, but then remove that code from the final version.

Macro Advantages and Disadvantages

Some programmers never use macros. Others create extensive libraries of complex macro definitions, extending assembly language to the point of having more macro identifiers in their programs than common assembly language mnemonics. Used this way, macros tend to be personal, letting programmers mold their individuality into Turbo Assembler.

For team programming projects, macros can help to ensure consistent coding techniques. For example, a software company might develop a macro library of common routines, reducing the frequency of bugs introduced by simple carelessness. Macros could be written to drive special hardware such as a custom CRT controller or a plotter. Team members would then be required to use the macros for all I/O to the device, ensuring that correct instruction sequences for specific operations are assembled.

Macros can also help clarify program logic by replacing cryptic assembly language mnemonics with macro names such as `GetValue` and `RingBell`. A good set of macro names can make assembly language programs look almost like Pascal or C.

But, despite these and other advantages, macros do have a few drawbacks. Unlike separate object-code modules that you can stuff into a library file for linking directly into programs, macros are stored in text form and, therefore, must be reassembled for each separate module. For this reason, an extensive macro library can increase assembly time, especially if only a few of the many macros in a library are actually used. Also, while helping to customize and clarify assembly language, macro definitions can easily hide the effects of individual instructions. A good example of this is a macro instruction that changes a register value—a fact that will not be obvious by simply reading the listing. Like subroutines, macros require careful documentation detailing the use of registers, flags, and variables.

Constructing Macros

You can define a macro anywhere in a program, but the most common (and probably the best) location of macro definitions is in the beginning of a file, near other equates, records, and structures. The simplest macro starts with the keyword `MACRO` and a name, followed by one or more instructions, and ends with `ENDM`:

```
MACRO  Terminate
      mov  ah, 04Ch      ;; "Exit program" function
      mov  al, [exCode]  ;; Load exCode into al
      int  21h          ;; Call DOS. Terminate program
ENDM   Terminate
```

You probably recognize these instructions—they're the same as those used in most of this book's programs to transfer control back to `COMMAND.COM` when the program is finished. If you insert this macro definition into a program—preferably above the `DATASEG` directive—you can then end the program by simply writing `Terminate`. During assembly, Turbo Assembler replaces the macro name with the instructions from the definition, a process called *macro expansion*. Of course, if you use the `Terminate` macro only once, it's hardly worth the effort to store the instructions in a macro. Even so, there's little doubt what `Terminate` means, and the additional clarity added to the program is itself an important benefit.

Notice that comments in this macro begin with double semicolons. As you know, comments normally begin with single semicolons. Both kinds of comments are allowed in macros, but those with single semicolons are written to the listing text file if you request one with the `/1` option when assembling. If the program uses the same macro dozens or more times, the repetitive comments are unsightly and might lengthen printing time. In that case, you can eliminate the comments from the macro expansions by preceding the text with double semicolons. (The comments are still listed along with the macro definition.)

Purging Macro Definitions

After reading a macro definition, Turbo Assembler remembers the macro name and instruction sequences throughout the program. When assembling large programs with extensive macro libraries, the assembler could run out of room for new symbols if your system has limited memory capacity. If this happens and you receive an out-of-memory error during assembly, you can purge the macro definitions you don't need, releasing additional memory for other uses. To purge a macro, use the `PURGE` keyword along with the macro name:

```
PURGE Terminate
```

After purging `Terminate`, Turbo Assembler no longer recognizes the macro name. Another reason to purge a macro definition is to replace a macro temporarily in a library with a new instruction sequence. This can be useful when you need to test a revision to a macro that you'll later add to the full macro library. For example, to change `Terminate` into a code sequence that restarts the program, you can write:

```

PURGE  Terminate
MACRO  Terminate
        jmp     Start
ENDM   Terminate

```

The `PURGE` directive removes `Terminate`'s old definition, after which a new macro of the same name is created. If you do this at the beginning of the program, every place that `Terminate` formerly ended the program will now jump to the beginning of the code at label `Start`: (not shown). You might do this to create a presentation version of your code, which runs normally but “never” ends.

NOTE

Turbo Debugger normally treats macro instructions as though they were native assembly language commands. Pressing F7 or F8 when the cursor is at a macro name executes all instructions associated with the macro. To execute a macro's individual instructions one by one, view the CPU window and press Ctrl-M to select the display style you prefer. Pressing F7 or F8 will then move separately through the macro's instructions.

Parameter Substitution

Adding parameters to macro definitions lets you change the way the macro expands at assembly time. Macro definitions can have three types of parameters:

- Symbolic parameters
- Numeric parameters
- String parameters

Symbolic parameters refer to register names, instruction mnemonics, and other assembly language keywords and identifiers. *Numeric parameters* are signed and unsigned integers or expressions. *String parameters* are plain, unterminated character strings. The use of a parameter determines the parameter's type and, for this reason, some parameters can represent more than one type of data. Name your parameters the same way you name other identifiers, listing the names on the first line of the macro definition:

```

MACRO  Swap16  v1, v2
        push   [word v1]
        push   [word v2]
        pop    [word v1]
        pop    [word v2]
ENDM   Swap16

```

This macro, named `Swap16`, defines two parameters `v1` and `v2`, called *dummy parameters* or, more correctly, *formal parameters*. There are no actual variables named `v1` and `v2` in the program—the two identifiers belong strictly to the macro definition. Multiple parameters are

separated by commas. The code inside the `swap16` macro uses the parameter names in `push` and `pop` instructions, first pushing the two words `v1` and `v2` onto the stack, and then immediately popping the same two parameters off the stack in the opposite order. The effect is to exchange the values of two variables in memory.

To use a macro with parameters, write the macro name followed by the actual items to process. For example, if you declare two word variables `countA` and `countB`, you can use the previous macro to swap their values:

```
DATASEG
countA  dw      100
countB  dw      200
CODESEG
swap16  countA, countB
```

`countA` and `countB` are called *actual parameters* because they represent the actual values to process. When expanding the macro, Turbo Assembler replaces the dummy (formal) parameters `v1` and `v2` with the actual parameters `countA` and `countB`, assembling the `swap16` macro as though you had written:

```
push    [word countA]
push    [word countB]
pop     [word countA]
pop     [word countB]
```

You can also pass register names to `Swap16`, representing pointers to data to swap. If `bx` addresses `countB`, then you could write:

```
swap16  bx, countA    ; swaps word at [bx] with [countA]
```

As an alternative, you can separate multiple parameters with blanks instead of commas. For example, this is identical to the previous instruction:

```
swap16  bx countA    ; separate parameters with commas or blanks
```

Because the dummy parameters can be replaced by symbols such as `bx` or by labels such as `countA` (which represent offset address values), in this example, `v1` and `v2` are numeric as well as symbolic parameters. The actual type depends on how the parameters are eventually used.

As these samples illustrate, parameters let you create general-purpose macros that you can reprogram to meet new demands. Understanding how to declare and use parameters is crucial to writing effective macros that do more than simply repeat common instruction sequences. The next section examines each of these kinds of macro parameters in detail.

NOTE

Parameter names such as `v1` and `v2` in the previous sample macros are local to the macro definitions. You can use the same names elsewhere as labels in other parts of the program without conflict.

Symbolic Parameters

Symbolic formal parameters can be replaced by any actual symbols, mnemonics, directives, and keywords normally used in assembly language programming. One use for symbolic parameters is to define new names for instructions. For example, you can give the processor a spelling lesson, replacing `mov` with `Move`:

```
MACRO  Move    aSym, bSym
        mov    aSym, bSym
ENDM   Move
```

In this example, `aSym` and `bSym` are the symbolic dummy parameters that are replaced by the names of registers or other text when the macro is used:

```
Move   ax, bx      ; Assembles to mov ax, bx
Move   [value], cx ; Assembles to mov [value], cx
mov    cx, dx      ; Assembles normally
```

You can now use `mov` or `Move` with identical results. (Touch typists may find this macro helpful, especially if, like me, you're constantly typing *move* with an *e* by mistake instead of *mov*.) You can also create symbolic dummy parameters that become new global labels when the macro is expanded. To demonstrate how this works, here's how to write a macro to reserve space for a word variable, the name of which is passed to the macro as a parameter:

```
MACRO  DeclareWord  vName, vValue
vName  dw           vValue
ENDM   DeclareWord
```

The `DeclareWord` macro expands to a `dw` directive, reserving one word of memory labeled `vName` and initialized to `vValue`. To create a word variable with the initial value of 100, you can write:

```
DeclareWord TheCount, 100
```

Of course, it's just as easy to use `dw` directly. A similar but more practical example illustrates how to write macros that automatically label variables according to their initial values. To accomplish this requires using the *substitute operator* `&`, which tells Turbo Assembler that the text after `&` is the name of a dummy parameter and not something else. The reason for this is easier to see in an example:

```
MACRO  Aword      vNum
Word&vNum  dw      vNum
ENDM   Aword
```

The `Aword` macro declares one formal parameter `vNum`. At the `dw` directive, the label `Word&vNum` tells Turbo Assembler that `vNum` refers to the formal parameter of this name. Without the `&`, the assembler would not be able to know that `vNum` in `WordvNum` refers to the formal parameter. Using the `Aword` macro automatically labels word variables:

```
Aword  1
Aword  2
Aword  3
```

The effect is to create three 16-bit variables named `Word1`, `Word2`, and `Word3`, as though you had written:

```
Word1  dw    1
Word2  dw    2
Word3  dw    3
```

Notice that with the macro, a single change modifies both the value and the label. For example, changing the 3 to 8 creates a word variable `Word8` initialized to 8. Without the macro, you'd have to change two numbers to do the same.

Numeric Parameters

As you can see in some of the previous examples, symbolic parameters are sometimes treated as numbers. For example, `vNum` in the `Aword` macro is a symbol when used as part of a label and a number when used to initialize a word variable. The context of the parameter's use determines the data type. A parameter is numeric only when a later instruction requires a number at this place. Let's examine another macro that uses both symbolic and numeric parameters:

```
MACRO  ShiftLeft      destination, count
        push    cx
        mov     cl, count
        shl    destination, cl
        pop     cx
ENDM   ShiftLeft
```

The `ShiftLeft` macro defines two parameters—`destination`, representing the register or memory location to shift, and `count`, representing the number of times to shift the target value left. You could write similar macros for other shift and rotate instructions, too. The instructions in the macro save `cx` on the stack, assign the numeric count parameter to `cl`, shift the `destination` left that many times, and then restore `cl`. To use the macro, write commands such as:

```
ShiftLeft  ax, 5
ShiftLeft  {value}, 3
ShiftLeft  <[word bx]>, 2
```

The first line shifts the value of `ax` left five times. The second line shifts variable `value` (not shown) left three times. The third line demonstrates a problem with parameters that have blanks. If you try to write:

```
ShiftLeft  [word bx], 2
```

you receive an error that the operand types do not match the macro definition. This occurs because blanks or commas separate multiple actual parameters. (Multiple formal parameters in the macro definition must be separated with commas.) To solve this dilemma, use `<` and `>` to surround parameters that contain blanks, as in:

```
ShiftLeft    <[byte si]>, 4
ShiftLeft    <[word bx + di]>, 2
```

When passing expressions to macro numeric parameters, you must decide when you want the expression to be evaluated. Normally, parameters are passed to the macro in text form with expressions such as `MySize * MyCount` being evaluated inside the macro. To force evaluation to occur before the macro is expanded, preface the expression with a percent sign `%`, the “Expression evaluate operator.” For example:

```
ShiftLeft    ax, MySize * MyCount
```

This points out a particularly troublesome aspect of macros and numeric parameters. Unfortunately, Turbo Assembler ignores the `* MyCount` portion of the expression, thinking that these symbols are merely extra parameters. To pass the expression to the macro, you have to use angle brackets as explained previously:

```
ShiftLeft    ax, <MySize * MyCount>
```

This solution is less than perfect, however, because the expression `MySize * MyCount` is passed as text to the macro. To evaluate and pass the expression *result*, use a leading percent sign like this:

```
ShiftLeft    ax, %MySize * MyCount
```

The percent sign forces the assembler to evaluate the expression and pass the final result to the macro. This can be useful if the macro’s formal parameter (count in this example) is used more than once. If you pass an expression as text, the assembler has to evaluate the expression each time it is used. If you pass the result of an expression, though, evaluation occurs only once.

String Parameters

As in the previous samples, you must surround string parameters with `<` and `>`, which tell the assembler that the enclosed text is literal, including blanks and punctuation normally used to separate individual identifiers. A useful macro employs this technique to declare ASCIIZ-format character string variables:

```
MACRO  ASCIIZ  name, chars
name   db      '&chars', 0    ;; String + null terminator
name&len dw    $ - name - 1   ;; Length of chars
ENDM   ASCIIZ
```

The ASCIIZ macro defines two parameters—`name`, which is used to create two labels, and `chars`, the characters that make up the string. Inside the macro, the `db` directive creates a null-terminated string, using `name` as the label. The `&` operator tells Turbo Assembler that `chars` is the name of a parameter. This is necessary to prevent the assembler from creating a string of the five characters: ‘c’, ‘h’, ‘a’, ‘r’, and ‘s’, which it would do if the literal quotes were not used in the macros. The `dw` directive stores the length of the string (minus the null terminator) as a word variable that follows the string. Although not part of the standard ASCIIZ

format, this length value gives programs a quick way to determine the length of a string—at least for string constants that don't change length. Notice how another & operator creates a label beginning with name and ending in "len." For example, if name is `MyString`, the length word would be labeled `MyStringLen`. To use the `ASCIIIZ` macro, surround the characters for the string in angle brackets:

```
ASCIIIZ s1, <Any old string will do>
ASCIIIZ s2, <Commas, and periods, work too.>
```

When Turbo Assembler processes these lines, it creates two strings, one at label `s1` and another at `s2`. In addition, the assembler stores the lengths of the strings at `s1Len` and `s2Len`. As a result, you can use the `StrLength` procedure in the `STRINGS` module to calculate string lengths or to load the lengths directly, as these examples illustrate:

```
mov    di, offset s1    ; Address string s1 with di
call   StrLength        ; Calculate cx = string length
mov    cx, [s1len]     ; Same as above two instructions
```

If the string length changes, you could call `StrLength` and then store the result at `s1len`. Assuming `cx` equals the new string length, you could write:

```
mov    [s1len], cx     ; Save new string length
```

NOTE

Use Turbo Debugger's `View:Variables` command to examine the labels and values created by the `ASCIIIZ` macro.

To create strings with characters interpreted specially in a macro, use an exclamation point (!), the "Quoted character operator." For example, to include an angle bracket as a character in a string, you can use the line:

```
ASCIIIZ s3, <Couldn't locate --!> >
```

The effect is to create a variable `s3` equal to the string "couldn't locate -->," which you would probably follow with a second string, perhaps a filename that couldn't be found on disk. The quoted character operator inserts the angle bracket (>) as a character. Notice also the double apostrophes, needed here to insert a single apostrophe because the `ASCIIIZ` macro uses this same character as string delimiters.

Macros and Variables

A good use for macros is to add custom data types such as the `ASCIIIZ` macro to assembly language. Any combination of directives such as `dw` and `db`, as described in previous chapters, can be used in macro definitions. Along with the `DUP` operator, this makes it easy to write macros to create arrays:

```
MACRO WordArray aName, aSize, aValue
aName&count    dw    aSize
aName          dw    aSize DUP (aValue)
ENDM WordArray
```

WordArray has three parameters: a label identifier (aName), the number of words in the array (aSize), and the initial value to assign to each word (aValue). In the macro's body, the first dw directive creates a variable equal to the number of words in the array, labeling this variable by the array name plus "count." The second dw directive declares the array values, using the DUP operator to reserve space for aSize values initialized to aValue. Two examples show how to use the macro:

```
WordArray    a1, 10, 0
WordArray    a2, 100, ?
```

Expanding these macro commands creates two arrays, the first at label a1 with ten words initialized to 0 and the second at label a2 with 100 uninitialized words. Two variables a1count and a2count are also created and initialized to the number of words in each array. Programs can read these variables to find out how many values the arrays hold:

```
mov    cx, [a1count]    ; Set cx = number of words in array a1
mov    cx, [a2count]    ; Set cx = number of words in array a2
```

Definitions that Repeat

Three directives—IRP, IRPC, and REPT—can be used to construct macros that repeat instructions, usually with different parameters on each repetition. The directives can be used alone or inside macros to create powerful new commands. As with plain macro definitions, end your repeating definitions with ENDM. Earlier, you learned how to use the REPT directive to create automatically initialized arrays. (For example, see lines 36-42 in Listing 7.2, SCREEN.ASM.) IRP operates similarly, but takes arguments listed inside angle brackets and separated by commas:

```
IRP    register, <ax, bx, cx, dx>
      inc    register
ENDM
```

When expanded during assembly, the effect is to create four inc instructions, one for each of the four registers listed in brackets:

```
inc    ax
inc    bx
inc    cx
inc    dx
```

The IRPC directive operates similarly to IRP but, instead of using arguments in brackets, it repeats the instructions for each letter in a string. (The C in IRPC stands for Character.) As the next example demonstrates, you can use IRPC to create strings where each character is stored in a word instead of a byte, as db normally does:

```

LABEL    chars    WORD
IRPC     nextChar, ABCDEFG
         dw       ' &nextChar'
ENDM

```

The LABEL directive is necessary in this case because the assembler doesn't allow a label to preface an IRPC construction directly. The dummy parameter nextChar takes successive characters from the string ABCDEFG, which does not require surrounding quotes. On each repetition, a dw directive creates a two-character variable consisting of a space and the ASCII value in this loop's nextChar. Notice how & identifies nextChar as a parameter name. The effect of this example is the same as writing:

```

char    dw       ' A'
        dw       ' B'
        dw       ' C'
        dw       ' D'
        dw       ' E'

```

NOTE

To see these characters in Turbo Debugger, use the View:Variables command, press Tab and arrow keys to position the cursor to chars, and call up the View:Dump window.

You can use IRP, IRPC, and REPT inside macros, too, which lets you give names to repeated constructions. A typical example uses IRP to push registers onto the stack at the start of a procedure:

```

MACRO   PushReg registers
IRP     reg, <registers>
        push    reg
ENDM
ENDM

```

Notice that two ENDM directives are required—one to end the IRP command and the other to end the macro. A corresponding macro pops the registers from the stack, presumably at the end of a procedure:

```

MACRO   PopReg registers
IRP     reg, <registers>
        pop     reg
ENDM
ENDM

```

In each macro, a dummy parameter named registers passes the register list to IRP. The reg parameter in the IRP loop takes successive values from this list, assembling one push or pop instruction for each reg value until the list is empty. Together, PushReg and PopReg simplify procedure design by making it unnecessary to write instruction sequences such as:

```

push    ax
push    bx
push    cx
push    dx

```

Instead, to push these same four registers, you can simply write:

```
PushReg <ax, bx, cx, dx>
```

The four registers listed inside angle brackets expand to four push instructions, one for each register. At the end of the procedure, you would then use `PopReg` to restore these registers in the reverse order. With the two macros, you can write your procedures in this general form:

```
PROC    Subroutine
        PushReg <ax, bx, cx, dx, si, di>
;
;----- Subroutine's instructions
;
        PopReg <di, si, dx, cx, bx, ax>
        ret
ENDP    Subroutine
```

NOTE

Before I'm accused of not practicing what I preach, I'd better explain that, to avoid using techniques before they are introduced and because macros are always optional, program listings in this book do not employ macros in procedures as suggested here to save and restore registers. You can certainly modify the listings to use `PushReg` and `PopReg`, which can save typing and can also help to eliminate bugs by forcing you to list pushed and popped registers on easy-to-compare single lines.

Macros and Code

As mentioned earlier, macros let you invent new commands that expand to individual assembly language instructions. Used this way, a macro is a kind of subroutine that is inserted directly in line with other instructions instead of requiring a `call` to activate. In fact, one way to optimize programs for top speed is to replace subroutine calls with macros that perform the same jobs. This can improve the program's performance by eliminating `call` and `ret` instructions. For example, suppose you have the procedure:

```
PROC    DecReg
        dec    ax
        dec    bx
        dec    cx
        dec    dx
        ret
ENDP    DecReg
```

After debugging the program, you decide to *unroll* the subroutine's instructions—that is, inserting the instructions directly where they are needed. The easiest way to do this is to create a macro:

```

MACRO  DecReg registers
  IRP   reg, <registers>
    dec  reg
  ENDM
ENDM

```

There are simpler ways to write this macro, of course, but while going to the trouble of putting macros into the code, you may as well make the macro as versatile as possible. After designing DecReg, you can then use your text editor's global search and replace (or a utility program) to translate all the `call DecReg` instructions to:

```
DecReg <ax, bx, cx, dx>
```

If DecReg is called often in the program, perhaps from inside a critical loop, the unrolled code runs faster by eliminating multiple executions of `call` and `ret` instructions. In addition, DecReg is even more useful as a macro than a subroutine because the macro allows you to decrement any combination of registers, which the procedure cannot do.

NOTE

Macros can also nest; that is, you can use a macro name inside another macro definition. Such macros can be powerful, but they can also expand to many lines of code.

Register Preservation

A potential danger lurks when a macro changes the value of one or more registers. Because the register names do not appear in the source code, you can easily miss this fact and expect a register to retain an important value. Some programmers write macros that preserve all registers with `push` and `pop` instructions:

```

MACRO  DispChar ch
  push  ax          ;; Save ax
  push  dx          ;; Save dx
  mov   ah, 2      ;; Load function number into ah
  mov   dl, '&ch'  ;; Load character to display
  int   21h        ;; Call DOS--display character ch
  pop   dx          ;; Restore saved dx
  pop   ax          ;; Restore saved ax
ENDM  DispChar

```

The `DispChar` macro defines a single parameter `ch`, which is assigned to register `dl`, again using the `&` operator to tell the assembler that `ch` is a parameter name and not the two characters `c` and `h` in quotes. Next, the number of the DOS standard output routine (2) is assigned to `ah`, after which `int 21h` calls DOS to write the character in `dl` to the standard output file. Two pairs of `push` and `pop` instructions save and restore the values of the registers used by the macro. In the program, you might use this macro to display a character:



DispChar <0>

If the `DispChar` macro does not preserve the registers it uses, you might easily forget that calling `DispChar` changes the values in `ah` and `dl`. Of course, the downside of this is that multiple uses of `DispChar` push and pop the same registers over and over, even when unnecessary. It's impossible to say whether you should or shouldn't preserve registers in your macros—the choice is up to you. If you don't, be careful to document the registers used by your macros—or get settled for some nice, long sessions with Turbo Debugger while you try to figure out why your programs aren't working.

Using the Include Directive

Although you can declare individual macros at the start of your program, a better plan is to store macro definitions in a separate text file and then load that file during assembly. To do this, insert an `INCLUDE` directive such as:

```
INCLUDE "MACROS.ASM" ; Read library of macro definitions
```

NOTE

You must use quotes around filenames when assembling `INCLUDE` directives in Ideal mode. In MASM mode, the quotes are not required, but then, you also can't end the line with a comment as shown here because the assembler would consider the comment to be part of the filename.

You can also include files containing other assembly language text—you don't have to use `INCLUDE` to load only macro definitions. The text in the included file is inserted into the program and assembled, as though the two files were one. Many programmers store a program's equates in separate files to be included as needed in one or more modules. An `INCLUDE` directive can appear anywhere inside the program text and can be used to load equates, macros, variables, and assembly language instructions. You can also nest multiple `INCLUDE` directives, having an included file include some more text, which includes still another file, and so forth.

In practice, it's probably best not to use `INCLUDE` to insert variables and instructions into programs. A better idea is to write separate object-code modules for these items and then link the code to your program, using the techniques explained for modules such as `SCREEN` and `STRINGS` in this book. Remember that included text is assembled over and over along with the other instructions in a program, while separately assembled object-code modules are immediately ready for linking.

Local Labels

Use the LOCAL directive inside a macro to create automatically-numbered local labels. The assembler creates the actual labels for you, eliminating the messy job of having to construct unique labels for macro loops and jump targets.

Insert a LOCAL directive after the macro's opening line:

```
MACRO AnyMacro
LOCAL  @yonder, @ponder
...
ENDM AnyMacro
```

Turbo Assembler replaces the labels yonder and ponder with numeric, local labels such as @@0001, @@0002, and @@0003. The symbols yonder and ponder are for your use in writing the macro—they do not appear in the actual labels that the assembler creates.

A more practical example demonstrates LOCAL. Following is a macro that uses LOCAL to create a loop:

```
MACRO Calln register, subroutine
LOCAL  @@restart, @@exit
    push register          ;; save register
    or  register, register ;; is register zero?
    jz  @@exit            ;; if yes exit, else continue
@@restart:
    call subroutine       ;; call the subroutine
    dec register          ;; subtract 1 from register
    jnz @@restart         ;; jump if register is not zero
@@exit:
    pop register          ;; restore register
ENDM Calln
```

The Calln macro calls a subroutine by the number of times specified in a register argument. A LOCAL directive creates two local labels, @@restart and @@exit. Instructions in the macro save and restore the specified register, call the subroutine, decrement the register, and jump to the local labels depending on the register's value.

Use the macro by first writing a subroutine to call. The example here simply returns:

```
PROC AnyProc
ret
ENDP AnyProc
```

Next, initialize a counting register, and call the subroutine with these instructions:

```
mov dx, 4 ; Assign count to dx
Calln dx, AnyProc ; Call AnyProc four times
```

The assembler expands this Calln macro instruction to create the following code:



```
        push    dx
        or     dx, dx
        jz     @@0001
@@0000:
        call   AnyProc
        dec   dx
        jnz   @@0000
@@0001:
        pop    dx
```

The assembler replaces the two local labels, `@@restart` and `@@exit`, with the numeric labels `@@0000` and `@@0001`. Most important, if you reuse the *same* macro within the scope of those labels, the assembler creates two *new* labels, `@@0002` and `@@0003`. This means you can use the `callon` macro repeatedly without introducing conflicting labels into the program.

Conditional Compilation

Conditional compilation directives form a kind of mini-language built into Turbo Assembler. With conditional directives, you can change the way a program assembles based on various conditions, normally defined at the start of a program module (or stored in a separate `INCLUDE` file) and assigned to identifiers called *conditional symbols*. For example, you could define a conditional symbol named `DisplayType` to indicate which kind of display adapter the computer has. To modify the program for new display hardware, you simply change `DisplayType` to the correct value and reassemble. Some software companies build hundreds of such symbols into programs, letting programmers quickly generate custom applications for customers by simply tweaking a few symbols here and there.

Table 8.1 lists Turbo assembler's conditional compilation directives, none of which directly generates any machine code. Pass-dependent directives such as `ERRIF1` and `ERRIF2` are included for compatibility with MASM, which processes assembly language programs in two passes. Because Turbo Assembler is a one-pass assembler, these directives should not be used. (Nor should they ever be needed.)

Defining Conditional Symbols

Define conditional symbols just as you do other equates, assigning a value, which must be numeric, to a named identifier. For example, to define a conditional symbol named `DisplayType`, you could write:

```
DisplayType    =    1
```

You can also use `EQU` to define conditional symbols, but normally you should use an equal sign, which creates a numeric symbol. Because the “1” in this example isn't very meaningful, you'll probably define other equates for assigning to your conditional symbols. For example, you might set up four symbols representing various common display types:

```
CGAAdapter    =    0
MonoAdapter   =    1
EGAAdapter    =    2
VGAAdapter    =    3
```

The actual values don't matter in this example—it's the names we're after, which lend extra readability to programs, as in the perfectly clear assignment:

```
DisplayType   =    EGAAdapter
```

Table 8.1. Conditional Compilation Directives.

<i>Directive</i>	<i>Meaning</i>
ELSE	Assemble next lines if previous IF is false
ELSEIF	End of ELSE directive. Begin new IF
ENDIF	End of IF directive
ERR	Force assembler to display error message
ERRIF	Error if an expression is true
ERRIF1	Error if on pass 1*
ERRIF2	Error if on pass 2*
ERRIFB	Error if an argument is blank
ERRIFDEF	Error if an argument is defined
ERRIFDIF	Error if arguments differ
ERRIFDIFI	Error if arguments differ (ignoring case)
ERRIFE	Error if an expression is false (equal to 0)
ERRIFIDN	Error if arguments are identical
ERRIFIDNI	Error if arguments are identical (ignoring case)
ERRIFNB	Error if an argument is not blank
ERRIFNDEF	Error if an argument is not defined
EXITM	Stop macro expansion immediately
GOTO target	Continue macro expansion at target
IF	Assemble if expression is true
IF1	Assemble if on pass 1*
IF2	Assemble if on pass 2*
IFB	Assemble if an argument is blank
IFDEF	Assemble if a symbol is defined

continues

Table 8.1. continued

<i>Directive</i>	<i>Meaning</i>
IFDIF	Assemble if arguments differ
IFDIFI	Assemble if arguments differ (ignoring case)
IFE	Assemble if an expression is false (equal to 0)
IFIDN	Assemble if arguments are identical
IFIDNI	Assemble if arguments are identical (ignoring case)
IFNB	Assemble if argument is not blank
IFNDEF	Assemble if argument is not defined

*Note: Pass 1 and 2 conditional directives, included for compatibility with MASM, should not be used in Turbo Assembler.

At this point in the program, the symbol `DisplayType` is said to be *defined* regardless of the value the symbol has. A symbol is defined as soon as you equate any value to that symbol. A symbol is *undefined* if the symbol is never assigned a value. Be sure to understand the difference between the value of a symbol and the fact that a symbol is or is not defined. These hints further explain the distinction:

- A symbol is defined when you equate any value to that symbol. The actual value is unimportant.
- A symbol is undefined if you never equate a value to that symbol.
- Testing whether a symbol is defined is not the same as testing whether a symbol has a specific value.
- For best results, use the equal sign to define conditional symbols, which should be numeric. This also allows you to later redefine the same symbols if necessary.

When creating conditional symbols, remember that symbol names represent simple values. This is important because conditional directives such as `IF` and `IFE` work only with expressions and arguments that evaluate to integer values.

Using Conditional Symbols

The most common use for conditional symbols is to select which of two or more sections of code is actually assembled. For example, suppose you need two versions of a program—one for debugging purposes and another for the final production model. The debugging version might include special instructions to display stack usage, dump important variables to the printer, and so forth. Naturally, you don't want to include such features in the production model. Conditional compilation directives make it easy to assemble either version by simply defining a few conditional symbols at the top of the program module:

```
False      = 0      ; Value meaning false
True       = 1      ; Value meaning true
Debugging  = True   ; False for production
```

You now have a way to tell the assembler which version to create, depending on the setting of Debugging. This lets you change variables, insert code, call debugging procedures, and modify other program features, all by setting Debugging to True and False. In the data segment, you could test Debugging in a conditional directive to change the program's identifying string:

```
DATASEG
IF Debugging
programID    db    'Chess v1.0 (TEST MODEL)', 0
ELSE
programID    db    'Chess v1.0', 0
ENDIF
```

When Turbo Assembler processes this directive, if Debugging is True (equal to any nonzero value), the "TEST MODEL" string is assembled; otherwise, the production string is assembled. Only one string is ever included in the final code, even though the program text appears to repeat "Chess v1.0" wastefully. There's no such waste because, if Debugging is False, the first db directive *is completely skipped during assembly*. Remember that conditional directives are commands to Turbo Assembler—the IF, ELSE, and ENDIF directives generate no code and are not instructions that execute at runtime.

Another test of Debugging might be used later on in the program's code segment. For example, perhaps the program must call a special subroutine to initialize values required only during debugging. This does the job:

```
If Debugging EQ True
    call    DebugInit    ; Initialize for debugging
ENDIF
```

If Debugging equals True, then the call instruction to DebugInit is assembled. Otherwise, the assembler completely skips the call. Another section of the program could then insert the debugging procedure only if Debugging is True:

```
IF Debugging
PROC    DebugInit
;
; ----- Debugging initialization subroutine
;
    ret    ; Return to caller
ENDP    DebugInit
ENDIF
```

Both the call to the subroutine and the procedure itself are added to the finished product only if Debugging is True. If Debugging is False, the program is assembled as though these items didn't exist.



You may have noticed in these samples that one `IF` directive used the expression `IF Debugging EQ True`, while the other simply states `IF Debugging`. Both forms are correct and have the same effect—as long as you follow the convention that any nonzero value (usually 1 or -1) represents `True` and that 0 represents `False`. The `EQ` operator in the first conditional directive is one of several listed in Table 8.2 that you can use in similar conditional expressions.

`IF` directives must be followed (eventually) by `ENDIF`, marking the end of the conditional section. In between, you can insert an optional `ELSE` clause, selecting alternate instructions that assemble if the expression evaluates to false. This lets you use `IF` alone:

Table 8.2. Constant Expression Operators.

<i>Operator</i>	<i>Meaning</i>
AND	Logical AND
EQ	Equal
GE	Greater or equal
GT	Greater than
LE	Less or equal
LT	Less than
MOD	Modulus (integer division remainder)
NE	Not equal
NOT	One's complement (bit toggle)
OR	Logical OR
SHL	Shift left
SHR	Shift right
XOR	Logical exclusive OR

```
IF Debugging
; code for debugging = True
ENDIF
```

or, with `ELSE` to select alternate instructions:

```
IF Debugging
; code for debugging = True
ELSE
; code for debugging = False
ENDIF
```

To Define or Not To Define

Instead of using `IF` to test if an expression evaluates to true (not 0) or `IFE` to test for false (equal to 0), you can use the `IFDEF` and `IFNDEF` directives to test if a symbol is defined or not defined. As you recall from earlier, a symbol is defined as soon as you give it a value. In a program, if you write:

```
IFDEF Debugging
call DebugInit
ENDIF
```

the `call` is assembled only if `Debugging` was assigned a value, no matter what that value is. To define `Debugging`, you might add to the beginning of the program the line:

```
Debugging      =      1      ; Define Debugging
```

To undefine the symbol, just remove this line or insert a semicolon at far left, converting the line into a comment. You can also test if symbols are not defined with statements such as:

```
IFNDEF Debugging
welcome        db          'Production version 5.01', 0
ENDIF
```

`IFDEF` and `IFNDEF` are most useful when used along with Turbo Assembler's `/d` option, which you can use to define symbols at the DOS command line. To assemble a program named `Banana` with debugging features, you could issue the command:

```
tasm /dDebugging=1 Banana
```

The `/dDebugging=1` defines the `Debugging` symbol when you assemble the program—there's no need to add a `Debugging` equate to the program source text. (The value assigned to the symbol is unimportant.) Notice that there is no space between the `/d` and the symbol name. Later, after debugging is no longer needed, assembling normally undefines `Debugging`, stripping the test code from the finished version:

```
tasm Banana
```

Handling Conditional Errors

You can create multiple conditionals with `IF`, `ELSE`, and `ELSEIF`, ending the whole shebang with `ENDIF`. For example, to define a string according to the display types listed earlier, you can write:

```
DATASEG
IF DisplayType EQ CGAAdapter
displayID      db          'CGA Adapter', 0
ELSEIF DisplayType EQ MonoAdapter
displayID      db          'Monochrome Adapter', 0
ELSEIF DisplayType EQ EGAAdapter
displayID      db          'EGA Adapter', 0
ELSEIF DisplayType EQ VGAAdapter
displayID      db          'VGA Adapter', 0
ENDIF
```



Only one string is defined in the final code, depending upon the `DisplayType` setting. However, this example is incomplete because it does not allow for the possibility that `DisplayType` could specify an unknown value. To handle this condition, you could replace `ENDIF` with:

```
ELSE
displayID      db      'Unknown adapter type', 0
ENDIF
```

Or, to prevent the program from assembling with an unknown condition, you can force an error to occur by replacing the original `ENDIF` with:

```
ELSE
ERR
DISPLAY "***Error** Unknown DisplayType value"
ENDIF
```

When this is assembled, if the `DisplayType` is unknown, the `ERR` directive forces Turbo Assembler to display a “user generated” error message. The `DISPLAY` directive also displays a quoted string, in this example, telling you that something is wrong with `DisplayType`. Assembling the program generates this text on screen:

```
Assembling file:  TEST.ASM
**Error** Unknown DisplayType value
**Error** TEST.ASM(102) User generated error
Error messages:  1
Warning messages:  None
Remaining memory:  331k
```

Ending Macro Expansion

Use the `ENDM` directive to end a macro expansion immediately. The directive is often useful for creating debugging macros that you want to delete from the final assembled program, but still retain in the assembly language text. For example, here’s a macro that pushes four registers and pauses with a jump instruction that repeats itself endlessly:

```
MACRO  PauseMac
LOCAL  @@here
      IFNDEF  DEBUGGING
      EXITM
      ENDEF
      ENDEF
          push ax
          push bx
          push cx
          push dx
@@here: jmp @@here ;; Pause program
ENDM  PauseMac
```

Insert the `PauseMac` macro to push `ax`, `bx`, `cx`, and `dx`, and then to jump in a continuous loop at label `@@here:`. Because this halts the program, you should execute this code *only* under control of a debugger so you can break out of the endless loop with a keypress (Ctrl+Break, for example).

The macro uses an `IFDEF` conditional directive to test whether a symbol, `DEBUGGING`, is *not* defined. If it isn't, `EXITM` immediately exits the macro expansion, and therefore, the effect is to delete the macro's instructions entirely from the program. If `DEBUGGING` is defined, `EXITM` is skipped and the `push` and `jmp` instructions are inserted. Define `DEBUGGING` with an equate such as the following—convert it to a comment or delete the line to not define `DEBUGGING`:

```
DEBUGGING      EQU      1
```

GOTO Directive

Your Turbo Assembler manual contains information on another directive, `GOTO`, which transfers macro expansion to another location. I find the directive to have questionable value, but you are supposed to be able to use it like this:

```
MACRO AnyMac
...
    GOTO location
...
location:
...
ENDM AnyMac
```

On reaching the `GOTO`, the assembler continues macro expansion at the designated target label, `location` in this example.

According to the Turbo Assembler User's Guide, you should not be able to use `GOTO` inside a conditional directive to alter macro expansion:

```
MACRO AnyMac
IFDEF DEBUGGING
    GOTO location
ENDIF
location:
...
ENDM AnyMac
```

This example, however, which is similar to the one in the Guide, does *not* work because it causes the macro processor to skip over the `ENDIF` directive. Consequently, the assembler terminates with the error "Open conditional" and the program does not assemble.

But never mind. The example is pointless since other conditional directives such as `IFDEF`, `IFDEF`, `ELSEIF`, and `EXITM` already give all the control needed over macro expansion. Frankly, I have found no practical use for the `GOTO` directive. If you do, please let me know.

Meanwhile, Back at the Macro...

Another new directive, `WHILE`, makes it possible to expand macros a specified number of times. For example, consider a simple macro that pushes the accumulator, `ax`, onto the stack:

```
MACRO PushAX
push ax
ENDM
```



To repeat the macro, you can of course write it multiple times:

```
PushAX
PushAX
PushAX
PushAX
```

But with `WHILE`, you can create a loop that expands the macro *while* an expression remains true. Here's one way to use `WHILE` to expand the preceding macro a specified number of times:

```
count = 4
      WHILE count GT 0
        PushAX
count = count - 1
      ENDM
```

The first line defines a numeric symbol, `count`, initialized to 4. (This line might appear in another file, or at the beginning of the program.) The `WHILE` directive expands the `PushAX` macro *while* `count` is greater than (GT) zero. Inside the `WHILE` directive, `count` is redefined to a value one less than its current value after each expansion of `PushAX`. Notice that the entire construction ends with `ENDM`—the `WHILE` directive is itself a predefined macro.

Pushing and Popping the Assembler State

Use the `PUSHSTATE` and `POPSTATE` directives to save and restore Turbo Assembler's operating state. The directives are particularly useful in macros that change various assembler options such as the current radix, or that use the `SMART` and `NOSMART` directives and other values. You may, however, use `PUSHSTATE` and `POPSTATE` outside of macro bodies to save and restore the assembler state at any time.

Inserting `PUSHSTATE` into a program preserves the following options and settings. Inserting a `POPSTATE` directive restores the most recently saved state values:

- The current `VERSION` setting (for example, `T400`)
- The operating mode (for example, `IDEAL` or `MASM`)
- Switch selections including `EMUL`, `NOEMUL`, `MULTERRS`, `NOMULTERRS`, `SMART`, `NOSMART`, `JUMPS`, `NOJUMPS`, `LOCALS`, and `NOLOCALS`
- Code generation selection (for example, `P8086` or `P386`)
- The current `RADIX`
- The current local label prefix (for example, `LOCALS @@`)

`PUSHSTATE` and `POPSTATE` are useful in macros, especially those that will be used under a variety of conditions. You can use the directives anywhere in a program like this:

```
PUSHSTATE
radix 2
NOJUMPS
...
POPSTATE
```

In that example, after `PUSHSTATE` saves the current assembler state, the program selects a radix of 2 and specifies the `NOJUMPS` switch. The ellipsis indicates where to insert instructions that require these settings. After that section of the program finishes, `POPSTATE` restores the previous settings.

You may also use the directives to create a macro that saves and restores the assembler's state. Simply begin and end the macro like this:

```
MACRO AnyMac
PUSHSTATE
    radix 2
...
POPSTATE
ENDM AnyMac
```

In the sample `AnyMac` macro, `PUSHSTATE` preserves the assembler's operating state before the macro sets the radix to 2. The ellipsis shows where to insert other macro instructions that require this radix setting. Just before the end of the macro body, `POPSTATE` restores the operating state to its former values.

Based on my test programs, when using the directives in macros, you must insert them *after* a `LOCALS` directive. Borland does not document or explain this oddity, but you can see its effect by assembling the following test macro:

```
MACRO AnyMac
LOCAL @@here
PUSHSTATE
    radix 2
POPSTATE
@@here:
ENDM AnyMac
```

Use the macro somewhere in your program by also inserting this instruction into a code segment:

```
AnyMac
```

If you then move `PUSHSTATE` in the macro to *before* the `LOCAL` directive, Turbo Assembler reports the error, "Symbol already different kind: @@HERE." Although the reason for this error is unclear, you can prevent it by always writing `PUSHSTATE` *after* a `LOCAL` directive.

**NOTE**

According to Borland, Turbo Assembler maintains a 16-level stack for use with these directives. Nesting PUSHSTATE more than 16 times is therefore not recommended, although tests show that doing so does not cause the assembler to report an error. Likewise, it is up to you to match every PUSHSTATE with a POPSTATE—a mistake here is also not considered an error, nor is the inclusion of more POPSTATES than PUSHSTATES. All of these conditions would seem to cause problems for the assembler, but because you receive no warnings or errors about them, you should use these directives with extreme care.

Starting a DOS Macro Library

Many assembly language programs spend a great deal of time calling DOS routines, all of which have special requirements, for example, expecting values to be in certain registers. The DOS macros in this section can help make writing programs easier in two ways: by reducing to single names the common sequences for calling DOS routines and by helping to document register assignments and other requirements.

Do not assemble the macros in Listing 8.1, DOSMACS.ASM. Instead, store the text file on disk and add the macros to your programs by including this line somewhere in the beginning of your program (preferably just before the DATASEG directive):

```
INCLUDE "DOSMACS.ASM"
```

Listing 8.1. DOSMACS.ASM.

```
1: ; DOS Macros for Ideal mode -- by Tom Swan
2: %NOLIST
3:
4: ;-----
5: ; MS_DOS          Call any DOS function
6: ;-----
7: ; Input:
8: ;     functionName = DOS function number
9: ; Output:
10: ;     depends upon specific function
11: ; Registers:
12: ;     depends upon specific function
13: ;-----
14: MACRO    MS_DOS    functionName
15:         mov     ah, functionName    ;; Assign function number
16:         int     21h                ;; Call DOS
17: ENDM     MS_DOS    functionName
18:
```

```

19: ;-----
20: ; (01h) DOS_GetChar    Get character with echo
21: ;-----
22: ; Input:
23: ;     none
24: ; Output:
25: ;     al = next character from standard input
26: ; Registers:
27: ;     ax
28: ;-----
29: MACRO  DOS_GetChar
30:     mov    ah, 1          ;; Assign DOS function number
31:     int   21h           ;; Call DOS
32: ENDM   DOS_GetChar
33:
34: ;-----
35: ; (02h) DOS_PutChar    Write character to standard output
36: ;-----
37: ; Input:
38: ;     dl = ASCII character (0-255)
39: ; Output:
40: ;     none
41: ; Registers:
42: ;     ah
43: ;-----
44: MACRO  DOS_PutChar
45:     mov    ah, 2          ;; Assign DOS function number
46:     int   21h           ;; Call DOS
47: ENDM   DOS_PutChar
48:
49: ;-----
50: ; (05h) DOS_PrintChar  Send character to standard list device
51: ;-----
52: ; Input:
53: ;     dl = ASCII character (0-255)
54: ; Output:
55: ;     none
56: ; Registers:
57: ;     ah
58: ;-----
59: MACRO  DOS_PrintChar
60:     mov    ah, 5          ;; Assign DOS function number
61:     int   21h           ;; Call DOS
62: ENDM   DOS_PrintChar
63:
64: ;-----
65: ; (07h) DOS_GetRawChar  Get unfiltered char with no echo
66: ;-----
67: ; Input:
68: ;     none
69: ; Output:
70: ;     al = next character from standard input
71: ; Registers:
72: ;     ax
73: ;-----

```

continues

Listing 8.1. continued

```

74: MACRO   DOS_GetRawChar
75:         mov     ah, 7             ;; Assign DOS function number
76:         int     21h             ;; Call DOS
77: ENDM    DOS_GetRawChar
78:
79: ;-----
80: ; (08h) DOS_GetCharNoEcho      Get filtered char with no echo
81: ;-----
82: ; Input:
83: ;     none
84: ; Output:
85: ;     al = next character from standard input
86: ; Registers:
87: ;     ax
88: ;-----
89: MACRO   DOS_GetCharNoEcho
90:         mov     ah, 8             ;; Assign DOS function number
91:         int     21h             ;; Call DOS
92: ENDM    DOS_GetCharNoEcho
93:
94: ;-----
95: ; (09h) DOS_PutString          Write ASCII$ string to standard output
96: ;-----
97: ; Input:
98: ;     string = label of ASCII$ variable
99: ; Output:
100: ;     none
101: ; Registers:
102: ;     ah, dx
103: ;-----
104: MACRO   DOS_PutString string
105:         mov     ah, 9             ;; Assign DOS function number
106:         mov     dx, offset string ;; Address string with ds:dx
107:         int     21h             ;; Call DOS
108: ENDM    DOS_PutString
109:
110: ;-----
111: ; (0Bh) DOS_Keypressed        Check if a keyboard character is waiting
112: ;-----
113: ; Input:
114: ;     none
115: ; Output:
116: ;     zf = 0 : (jnz) A character is waiting to be read
117: ;     zf = 1 : (jz) No character is waiting
118: ; Registers:
119: ;     ax
120: ;-----
121: MACRO   DOS_Keypressed
122:         mov     ah, 0Bh          ;; Assign DOS function number
123:         int     21h             ;; Call DOS
124:         or      al, al          ;; Set/clear zf
125: ENDM    DOS_Keypressed
126:

```

```

127: ;-----
128: ; (0Eh) DOS_SetDrive   Change current drive
129: ;-----
130: ; Input:
131: ;     dl = drive number (0=A:, 1=B:, 2=C:, ..., 25=Z:)
132: ;     Note: F: to Z: requires LASTDRIVE=Z in CONFIG.SYS file
133: ; Output:
134: ;     al = total number of drives available
135: ; Registers:
136: ;     ax
137: ;-----
138: MACRO   DOS_SetDrive
139:     mov   ah, 0Eh           ;; Assign DOS function number
140:     int   21h             ;; Call DOS
141: ENDM    DOS_SetDrive
142:
143: ;-----
144: ; (19h) DOS_GetDrive   Get current drive number
145: ;-----
146: ; Input:
147: ;     none
148: ; Output:
149: ;     al = drive number (0=A:, 1=B:, 2=C:, ..., 25=Z:)
150: ; Registers:
151: ;     ax
152: ;-----
153: MACRO   DOS_GetDrive
154:     mov   ah, 19h          ;; Assign DOS function number
155:     int   21h             ;; Call DOS
156: ENDM    DOS_GetDrive
157:
158: ;-----
159: ; (25h) DOS_SetVector  Set interrupt vector
160: ;-----
161: ; Input:
162: ;     interrupt = interrupt number (0-255)
163: ;     address   = label at start of interrupt routine
164: ; Output:
165: ;     none
166: ; Registers:
167: ;     ax, dx
168: ;-----
169: MACRO   DOS_SetVector  interrupt, address
170:     push  ds               ;; Save current ds register
171:     mov   ax, SEG address ;; Assign segment address of
172:     mov   ds, ax          ;; interrupt service to ds
173:     mov   dx, OFFSET address ;; Assign offset address to dx
174:     mov   ah, 025h        ;; Assign DOS function number
175:     mov   al, interrupt   ;; Assign interrupt number to al
176:     int   21h             ;; Call DOS
177:     pop   ds              ;; Restore ds segment register
178: ENDM    DOS_SetVector
179:

```

continues

Listing 8.1. continued

```

180: ;-----
181: ; (35h) DOS_GetVector  Get interrupt vector
182: ;-----
183: ; Input:
184: ;     interrupt = interrupt number
185: ; Output:
186: ;     es:bx = segment:offset address of interrupt
187: ; Registers:
188: ;     ax, bx, es
189: ;-----
190: MACRO  DOS_GetVector  interrupt
191:     mov    al, interrupt    ;; Assign interrupt number to al
192:     mov    ah, 35h         ;; Assign DOS function number
193:     int    21h             ;; Call DOS
194: ENDM   DOS_GetVector
195:
196: ;-----
197: ; (3Bh) DOS_ChDir      Change current directory
198: ;-----
199: ; Input:
200: ;     dirName = label of ASCIIIZ string in ds data segment
201: ; Output:
202: ;     cf = 0 : (jnc) Change was successful
203: ;
204: ;     cf = 1 : (jc) Change was not successful
205: ;     ax = error code (3=directory not found)
206: ; Registers:
207: ;     ax, dx
208: ;-----
209: MACRO  DOS_ChDir  dirName
210:     mov    ah, 3Bh         ;; Assign DOS function number
211:     mov    dx, OFFSET dirName ;; Assign string address to ds:dx
212:     int    21h             ;; Call DOS
213: ENDM   DOS_ChDir
214:
215: ;-----
216: ; (3Ch) DOS_CreateFile Create new file
217: ;-----
218: ; Input:
219: ;     fileName = label of ASCIIIZ string in ds data segment
220: ;     cx = attribute to use in directory
221: ;         00 = normal file
222: ;         01 = read-only (access denied for read/write)
223: ;         02 = hidden (DIR does not show name)
224: ;         04 = system file
225: ; Output:
226: ;     cf = 0 : (jnc) File created
227: ;     ax = file handle for future operations
228: ;
229: ;     cf = 1 : (jc) File not created
230: ;     ax = error code
231: ;         3 = path not found
232: ;         4 = no more handles available
233: ;         5 = access denied
234: ; Registers:

```

```

235: ;      ax, dx
236: ;-----
237: MACRO  DOS_CreateFile  fileName
238:      mov    ah, 3Ch      ;; Assign DOS function number
239:      mov    dx, OFFSET fileName ;; Assign name address to ds:dx
240:      int    21h         ;; Call DOS
241: ENDM   DOS_CreateFile
242:
243: ;-----
244: ; (3Dh) DOS_OpenFile   Open file for I/O
245: ;-----
246: ; Input:
247: ;      fileName = label of ASCIIZ string in ds data segment
248: ; Output:
249: ;      cf = 0 : (jnc) File opened
250: ;      ax = file handle for future operations
251: ;
252: ;      cf = 1 : (jc) File not opened
253: ;      ax = error code
254: ;          2 = file not found
255: ;          3 = path not found
256: ;          4 = no more handles available
257: ;          5 = access denied
258: ; Registers:
259: ;      ax, dx
260: ;-----
261: MACRO  DOS_OpenFile  fileName
262:      mov    ah, 3Dh      ;; Assign DOS function number
263:      mov    al, 02       ;; Open for read/write access
264:      mov    dx, OFFSET fileName ;; Assign name address to ds:dx
265:      int    21h         ;; Call DOS
266: ENDM   DOS_OpenFile
267:
268: ;-----
269: ; (3Eh) DOS_CloseFile  Close a previously opened file
270: ;-----
271: ; Input:
272: ;      bx = file handle from DOS_CreateFile or DOS_OpenFile
273: ; Output:
274: ;      cf = 0 : (jnc) File closed
275: ;
276: ;      cf = 1 : (jc) File not closed
277: ;      ax = error code
278: ;          6 = bad handle or file was not open
279: ; Registers:
280: ;      ax
281: ;-----
282: MACRO  DOS_CloseFile
283:      mov    ah, 3Eh      ;; Assign DOS function number
284:      int    21h         ;; Call DOS
285: ENDM   DOS_CloseFile
286:
287: ;-----
288: ; (3Fh) DOS_ReadFile   Read from file or device
289: ;-----
290: ; Input:

```

Listing 8.1. continued

```

291: ;      bx = file handle from DOS_CreateFile or DOS_OpenFile
292: ;      cx = number of bytes requested to read
293: ;      buffer = label of destination buffer in ds data segment
294: ;      Note: buffer must be at least cx bytes long!
295: ; Output:
296: ;      cf = 0 : (jnc) Read was successful
297: ;      ax = actual number of bytes read (0=at end of file)
298: ;
299: ;      cf = 1 : (jc) Read was not successful
300: ;      ax = error code
301: ;          5 = access denied
302: ;          6 = bad handle or file was not open
303: ; Registers:
304: ;      ax, dx
305: ;-----
306: MACRO  DOS_ReadFile  buffer
307:      mov  ah, 3Fh      ;; Assign DOS function number
308:      mov  dx, OFFSET buffer ;; Address buffer with ds:dx
309:      int  21h          ;; Call DOS
310: ENDM   DOS_ReadFile
311:
312: ;-----
313: ; (40h) DOS_WriteFile  Write to file or device
314: ;-----
315: ; Input:
316: ;      bx = file handle from DOS_CreateFile or DOS_OpenFile
317: ;      cx = number of bytes requested to write
318: ;      buffer = label of source buffer in ds data segment
319: ; Output:
320: ;      cf = 0 : (jnc) Write was successful
321: ;      ax = actual number of bytes written (0=disk is full)
322: ;
323: ;      cf = 1 : (jc) Write was not successful
324: ;      ax = error code
325: ;          5 = access denied
326: ;          6 = bad handle or file was not open
327: ; Registers:
328: ;      ax, dx
329: ;-----
330: MACRO  DOS_WriteFile  buffer
331:      mov  ah, 40h      ;; Assign DOS function number
332:      mov  dx, OFFSET buffer ;; Address buffer with ds:dx
333:      int  21h          ;; Call DOS
334: ENDM   DOS_WriteFile
335:
336: ;-----
337: ; (42h) DOS_Seek      Change location for next read/write
338: ;-----
339: ; Input:
340: ;      bx = file handle from DOS_CreateFile or DOS_OpenFile
341: ;      cx = high word of 32-bit byte offset
342: ;      dx = low word of 32-bit byte offset
343: ; Output:
344: ;      cf = 0 : (jnc) Seek was successful
345: ;      dx = high word of 32-bit offset position after seek
346: ;      ax = low word of 32-bit offset position after seek
347: ;

```



```

348: ;      cf = 1 : (jc) Seek was not successful
349: ;      ax = error code
350: ;      6 = bad handle or file was not open
351: ; Registers:
352: ;      ax
353: ;-----
354: MACRO  DOS_Seek
355:     mov  ah, 42h      ;; Assign DOS function number
356:     xor  al, al       ;; Seeks to absolute position in cx,dx
357:     int  21h         ;; Call DOS
358: ENDM   DOS_Seek
359:
360: ;-----
361: ; (47h) DOS_GetDir   Get name of current directory
362: ;-----
363: ; Input:
364: ;     string = address of 64-byte (minimum) variable
365: ; Output:
366: ;     directory name inserted into string in ASCIIZ format
367: ; Registers:
368: ;     ax, dl, si
369: ;-----
370: MACRO  DOS_GetDir  string
371:     mov  ah, 47h      ;; Assign DOS function number
372:     xor  dl, dl       ;; 0 specifies current drive
373:     mov  si, OFFSET string ;; Address string with ds:si
374:     int  21h         ;; Call DOS
375: ENDM   DOS_GetDir
376:
377: ;-----
378: ; (4Ch) DOS_Terminate  End program
379: ;-----
380: ; Input:
381: ;     code = [label] or value to pass to DOS or parent process
382: ; Output:
383: ;     none
384: ; Registers:
385: ;     ax
386: ;-----
387: MACRO  DOS_Terminate  code
388:     mov  ah, 4Ch      ;; Assign DOS function number
389:     mov  al, code     ;; Assign return code
390:     int  21h         ;; Call DOS
391: ENDM   DOS_Terminate
392:
393: %LIST

```

Using DOSMACS.ASM

Most of the macros in DOSMACS should be self-explanatory—just read the comments preceding each macro for a list of all requirements, output, and modified registers. The DOSMACS.ASM file begins with a %NOLIST command to prevent listing the macro definitions even if you specify the /1 listing option during assembly. This reduces the length of your program listings by not repeating the same text for all modules that include the macros. For reference, Table 8.3 lists each macro along with the associated function number in hexadecimal.

**Table 8.3. DOSMACS Macros.**

No.	MACRO Name and Parameters
-	MS_DOS <i>functionNumber</i>
01h	DOS_GetChar
02h	DOS_PutChar
05h	DOS_PrintChar
07h	DOS_GetRawChar
08h	DOS_GetCharNo Echo
09h	DOS_PutString <i>string</i>
0Bh	DOS_Keypressed
0Eh	DOS_SetDrive
19h	DOS_GetDrive
25h	DOS_SetVector <i>interrupt, address</i>
35h	DOS_GetVector <i>interrupt</i>
3Bh	DOS_ChDir <i>dirName</i>
3Ch	DOS_CreateFile <i>fileName</i>
3Dh	DOS_OpenFile <i>fileName</i>
3Eh	DOS_CloseFile
3Fh	DOS_ReadFile <i>buffer</i>
40h	DOS_WriteFile <i>buffer</i>
42h	DOS_Seek
47h	DOS_GetDir <i>string</i>
4Ch	DOS_Terminate <i>code</i>

NOTE

DOSMACS contains only a subset of DOS functions. A good project would be to expand DOSMACS to the full DOS set; be aware that this will also increase the time it takes to assemble programs that include the macros.

You can also call DOS functions by number, using the MS_DOS macro instead of loading `ah` and executing `int 21h`. Remember that this changes `ah`. To display a character loaded into `d1`, you could write:

```

mov     dl, 'A'      ; Character to display
MS_DOS 2            ; Call DOS output-character function

```

To use a macro that specifies parameters, read the comments, load a register, or allocate space for a variable and use the label identifier as the parameter. For writing ASCII\$ strings to the standard output file, use instructions such as:

```

DATASEG
Welcome      db      'Welcome to my program', '$'
CODESEG
DOS_PutString Welcome ; Display welcome message

```

Some macros return results in registers and flags. For instance, to check whether a character is available from the keyboard, you can write:

```

@@10:  DOS_Keypressed      ; Is a keypress waiting?
        jz      Continue   ; Jump if not
        DOS_GetRawChar     ; Else get the char (no echo)
        call   ProcessChar ; Call routine to process char
Continue:

```

If `DOS_Keypressed` sets the `zf` flag, then no character is waiting to be read, and the program continues at label `Continue:`. If `zf` is reset, then a second macro `DOS_GetRawChar` reads the character and calls a subroutine `ProcessChar` (not shown) to handle the keystroke. The macros help document the program by converting DOS function numbers into understandable names.

NOTE

If you receive a strange error such as an “Undefined symbol” when using known keywords such as `OFFSET`, check that you have specified all required parameters. Also, try surrounding parameters with angle brackets as in `<OFFSET CodeLabel>`. If you still can't determine what's causing an error, insert `%MACS` at the start of the program and assemble with the `/1` option to create a listing showing your macro calls along with the expanded instructions. You should be able to figure out what is going wrong by reading this listing.

Summary

By storing common instruction sequences in macro definitions, you add custom commands to Turbo Assembler. Macros can clarify assembly language, reduce the size of the program text, and help to ensure consistent programming methods, especially in team projects. Macros have a few drawbacks, such as requiring modules to reassemble the macro library repeatedly and hiding effects on register values.

A macro definition begins with `MACRO` and ends with `ENDM`. Purging a macro with `PURGE` removes the macro definition from memory, conserving RAM and letting you replace individual macros, perhaps for testing revisions.



There are three types of macro parameters: symbolic, numeric, and string. Formal parameters are listed in the macro definition. Actual parameters are listed when the macro is used. In the program, when Turbo Assembler encounters a macro name, it expands the macro, replacing the macro name with the instructions from the macro definition and inserting the actual parameters for the formal parameter names. Parameters let you write programmable macros that change according to new requirements.

Macros can be used to define new data types, using common directives like `db` and `dw`. Code macros can be used to unroll subroutines, replacing `call` instructions with in-line code, an important optimization technique that can increase program speed. Repetitive macros can generate multiple instructions for lists of register values and characters.

Use the `LOCAL` directive inside a macro to create automatically-numbered local labels. Use the `ENDM` directive to end a macro expansion immediately. Use `WHILE` to repeat a macro expansion a specified number of times, or while some other condition remains true.

To preserve the assembler's state, including many of its options and settings, insert a `PUSHSTATE` directive anywhere in a program. To restore the most recently saved assembler state, insert a `POPSTATE` directive. You may also use `PUSHSTATE` and `POPSTATE` inside macros.

Conditional symbols and directives let you write programs that assemble differently based on conditions defined at the beginning of the program. A conditional symbol is a numeric equate. By definition, a symbol is defined when you assign a value. Various directives such as `IF` and `IFE` can test the value of symbols and expressions involving symbols. Other directives such as `IFDEF` and `IFNDEF` test if symbols are defined.

Multiple macros are often stored in text files and then loaded into modules with an `INCLUDE` directive. This chapter includes a sample macro library, `DOSMACS.ASM`, with several macros for calling common DOS functions.

Exercises

- 8.1. What are some of the advantages and disadvantages of using macros?
- 8.2. Write a macro named `Startup` to initialize registers `es` and `ds` at the start of a program.
- 8.3. What value or values should the conditions *true* and *false* have? What value or values are typically used to represent *true*?
- 8.4. What do double semicolons `::` do?
- 8.5. How do you throw away a macro definition?
- 8.6. How do you specify a parameter's type in a macro definition?
- 8.7. Write macros `stz` and `c1z` to set and clear the zero flag `zf`. The macros should not affect any other flags and should preserve all register values.

- 8.8. Write a macro to assign a literal value to any segment register. Show how to use your macro to set `es` to the address of the color video buffer `0B800h`.
- 8.9. What instruction or instructions would you use to add the hypothetical macro library files `FLOAT.MAX`, `BIOSMAC.TXT`, and `CUSTOM.MAX` to program?
- 8.10. Create a conditional symbol named `HasFastCrt` set to true or false at the beginning of a program, indicating whether the system has a memory-mapped video display, as do all PCs, or a slower “dumb” terminal, such as might be found on mainframes and older PCs. Use your symbol in a subroutine that displays a character, appropriately selecting the `SCREEN` module’s `ScPokeChar` routine (see Chapter 7) or a similar DOS output function. The procedure should operate identically in all respects regardless of the selected hardware. You may use `DOSMACS.ASM` in your answer.

Projects

- 8.1. Apply the same idea expressed in exercise #8.10 to all procedures in the `SCREEN` module, creating a module that you can assemble for PCs with memory-mapped video or for systems using a slower dumb terminal as the main console.
- 8.2. Write a module to select features for a variety of printers, conditionally selecting code to switch on bold face printing, underlining, and other options. Construct your code to allow printing text on plain printers lacking such features.
- 8.3. Create a `BIOSMAC.ASM` library of macros similar to `DOSMACS.ASM` in this chapter. Your routines should make it easy to call ROM BIOS functions, as listed in a PC reference book (see Bibliography).
- 8.4. Locate a public domain assembly language listing (or take one of the listings from this book) that makes repeated subroutine calls. Replace the subroutines with macros, injecting code directly in line with other instructions. Test the effects this has on program speed and code-file size.
- 8.5. Create a library of macros files and object-code modules that make it easy to add standard debugging features to programs. Include routines to display (or print) stack usage by procedures, to list values of key variables, and to verify other values, for example, the range of an array index.
- 8.6. Write macros that use conditional directives to create variables in `ASCIIZ` and `ASCII$` formats, with and without automatic length variables.

9

CHAPTER

Disk-File Processing

- Getting a Handle on Files, 338
- Disk-File Concepts, 338
- Maximum Files, 339
- Opening and Closing Files, 339
- Flushing File Buffers, 340
- Closing Files, 341
- Dealing with Disk Errors, 341
- Creating New Files, 345
- Reading the DOS Command Line, 346
- Reading and Writing Text Files, 354
- Reading and Writing Data Files, 359
- Reading the Disk Directory, 361
- Summary, 366
- Exercises, 367
- Projects, 367

Getting a Handle on Files

The concept of a file handle was introduced beginning with DOS version 2.0. As explained in Chapter 7, “Input and Output,” handles are nothing mysterious. They are simply 16-bit unsigned integers that DOS and programs use to refer to logical files attached to devices such as printers and keyboards. This chapter expands on that theme, showing how to use handles in assembly language programs to process data stored in disk files—including files on floppy disks, hard disk drives, and similar devices.

Before DOS 2.0, disk file I/O was accomplished by maintaining data structures called *file-control blocks* (FCB). Various fields in an FCB keep track of the location affected by subsequent read or write operations, the size of records in a file, plus other facts, many of which are required by DOS but seldom (if ever) of direct use in a program. File handles simplify disk file I/O by eliminating the need to create and keep track of FCBs, but without sacrificing any operational abilities. After creating a new file or opening an existing file on disk, a single file handle is all you need to activate even the most sophisticated file operations. For these reasons and because Microsoft discourages using older FCB function calls, this chapter concentrates exclusively on the newer file-handle methods.

Disk-File Concepts

Before writing programs to read and write data in disk files, it’s important to understand a few universal concepts associated with disk file I/O. Later in this chapter, you’ll learn how to put these important concepts into practice:

- You must open a file before you can read data from the file or write new data to disk. Opening existing files preserves information previously stored in the file.
- Creating a new file also opens the file for I/O but erases any information stored in an existing file of the same name, if one exists.
- DOS temporarily stores in memory buffers the data you write to disk files. Never assume that a disk write operation actually transfers any data to disk.
- Closing a file writes any buffered data to disk, ensuring that all data previously written is saved.
- Closing a file also updates the file’s entry in the disk directory and releases the file handle for future use.
- The *current location* is a pointer to the place in the file where the next read or write operation will begin. DOS keeps this pointer for you. You can move the current location around at will to access data at different locations in a file, but there is only one such pointer associated with each open file.

Maximum Files

Every program can simultaneously have open a maximum of 20 files, up to a grand total of 255 files for all active programs. When one program runs another by calling the DOS Exec function 04Bh, DOS allocates to the new program a maximum of 20 file handles, as long as this does not exceed the total of 255 file handles permitted for all executing programs. Ending a program with DOS function 04Ch closes all active file handles, releasing the handles for use by other programs. Out of the 20 available file handles available to each active program, DOS reserves the five handles 0 through 4 for standard I/O devices (see Chapter 7) therefore, programs are normally limited to opening 15 files. To increase this limit, you can close one or more of the standard handles. For example, programs that don't call DOS functions to drive the printer and serial I/O ports can gain two more files by executing:

```

mov  ah, 03Eh      ; DOS Close-File function number
mov  bx, 3         ; Set bx to AUX file-handle number (3)
int  21h          ; Call DOS to close file
inc  bx           ; Set bx to PRN file-handle number (4)
int  21h          ; Call DOS to close file

```

Opening and Closing Files

Opening a file for reading and writing is like opening a door before carrying furniture in and out. After opening a file, you may read and write data in the file as often as you wish—provided, of course, no errors occur. To open a disk file in assembly language, pass the address of the filename in ASCII string format to DOS function 03Dh as in this sample:

```

DATASEG
fileName      DB      'C:\TASM\TEST.ASM', 0
CODESEG
mov  ax, @data      ; Initialize ds to address
mov  ds, ax         ; of data segment
mov  dx, offset fileName ; Address filename with ds:dx
mov  ah, 03Dh       ; DOS Open-File function number
mov  al, 0          ; 0 = Read-only access
int  21h           ; Call DOS to open file
jc   Error         ; Call routine to handle errors

```

The filename may specify a disk drive letter and subdirectory path names as in this sample. After initializing segment register *ds* (as you must do in all programs), use *ds:dx* to address the filename for function call 03Dh. In addition, register *al* is set to 0, telling DOS to allow only read operations on this file. Under DOS 2.0 and later versions, *al* can be one of three values:

- *al* = 0 = Read-only operations
- *al* = 1 = Write-only operations
- *al* = 2 = Read and write operations

Under DOS 3.0 and later versions, additional values for shared files in a networked system are available. (See the Bibliography for DOS references that describe these values.) After calling DOS to open a file, the carry flag *cf* indicates whether the operation was successful. As the previous sample code shows, this lets you use conditional jumps such as *jc* to jump to an error routine if the operation fails, probably because the registered file was not found. In this case, *ax* holds one of the error codes listed in Table 9.1. If no error occurred, then *ax* holds the file handle, which you can use for subsequent operations. Usually, it's a good idea to store this handle immediately in a variable, freeing *ax* for other uses:

```

DATASEG
handle  DW      ?           ; Word variable for file handle
CODESEG
;
; open file with DOS function 03Dh
;
mov     [handle], ax       ; Save file handle for later

```

Table 9.1. Open-File Error Codes.

<i>Error Code</i>	<i>Meaning</i>
01	File sharing not enabled
02	File does not exist
03	Path or file does not exist
04	No more handles available
05	Access denied (wrong file attribute)
0Ch	Bad access value in register <i>al</i>

Flushing File Buffers

A *file buffer* is an area of memory that serves as a kind of way station for data traveling to and from disk. Your program may also create private file buffers for storing data. Be aware that DOS has its own file buffers, controlled by the `BUFFERS = n` command in your `CONFIG.SYS` file. Most authorities recommend setting *n* to 20 to ensure at least one buffer for each of the maximum number of files a program might use.

When you write data to a file, the data is probably stored temporarily in a file buffer instead of being written directly to disk. Later, when the program reads other data from the file, opens a new file, or performs other file operations, DOS may flush the modified buffers to disk to make room in memory for the new data. Always be aware of this delayed action—the data you write to disk may not be permanently stored until later. To force any buffered data to be written to disk, duplicate the file handle with DOS function 45h and then close the duplicate, leaving the original file handle open:

```

mov    ah, 45h          ; Duplicate-handle function number
mov    bx, [handle]    ; Handle to duplicate
int    21h             ; Call DOS
jc     Error           ; Jump if error occurs (cf = 1)
mov    bx, ax          ; Assign duplicate handle to bx
mov    ah, 3Eh         ; Close-file function number
int    21h             ; Call DOS
jc     Error           ; Jump if error occurs (cf = 1)

```

Closing Files

Closing a file is simple—just pass in register `bx` the handle of any open file to function `03Eh`. Closing a file instructs DOS to write to disk any data held in memory buffers and to update the directory entry for the file, recording the file size, date, and time. Assuming that you opened the file as described previously and saved the file handle, close the file with:

```

mov    bx, [handle]    ; Assign handle to bx
mov    ah, 03Eh        ; DOS Close-File function number
int    21h             ; Call DOS to close the file
jc     Error           ; Jump if error detected

```

After calling DOS function `03Eh`, check the carry flag as suggested here with a `jc` instruction. If `cf = 1`, then `ax` holds an error code, probably `6`, indicating that the handle is bad (maybe you didn't assign the correct handle to `bx`) or the file was not open.

Closing files releases their handles for future use. Although it's good programming practice to close all open files before ending a program, DOS function `04Ch`, which almost all example programs in this book use to transfer back to DOS, also closes all open file handles as one of its clean-up chores. This means that you can open several files, read and write data, and just end your program with confidence that DOS will save to disk any modified data in memory.

Dealing with Disk Errors

When processing files, you must be careful to detect and deal with all possible error conditions. This is especially important in assembly language programming, which lacks the built-in error mechanisms typically found in Pascal and BASIC. It's your responsibility to detect errors, to display appropriate warnings and messages, and to take appropriate actions when the disk is full and when other problems occur.

In all cases, the carry flag indicates the success (`cf = 0`) or failure (`cf = 1`) of a file operation; therefore, you should always check the carry flag after every file function call. What you do after this is up to you. On the simplest level, you can simply end the program whenever an error occurs. (Remember that this closes all open files.) Or you might return to a known place—the main menu, for example—allowing users to retry the failed operation. For more

details, you can also call function 059h, which interrogates DOS for additional error information. (You can do this after any 21h call, by the way. The function is not just for file operations.)

Listing 9.1, DISKERR.ASM, uses this method in a subroutine to obtain extended error information from DOS and to display an appropriate message. The program is written as a library module, which you can link to your own programs (and to others in this chapter) as part of your error-control logic. Assemble the module and add the object code to your MTA.LIB library file with the commands:

```
tasm /zi diskerr
tlib /E mta -+diskerr
```

Repeat these steps if you later modify DISKERR.ASM, and ignore the usual warning that DISKERR is not in the library the first time you execute the tlib command. To reduce code-file size, leave out the /zi option, required only for running programs in Turbo Debugger.

Listing 9.1. DISKERR.ASM.

```
1: %TITLE "Disk-Error Handler -- by Tom Swan"
2:
3:         IDEAL
4:
5:         MODEL    small
6:
7:         DATASEG
8:
9: errString      DB      '** ERROR: ', 0
10:
11: err00  DB      'Unknown cause', 0
12: err01  DB      'Bad function number', 0
13: err02  DB      'File not found', 0
14: err03  DB      'Path not found', 0
15: err04  DB      'Too many open files', 0
16: err05  DB      'Access denied', 0
17: err06  DB      'File handle invalid', 0
18: err07  DB      'Memory control blocks destroyed', 0
19: err08  DB      'Not enough memory for operation', 0
20: err09  DB      'Bad memory block address', 0
21: err0A  DB      'Bad environment', 0
22: err0B  DB      'Bad format', 0
23: err0C  DB      'Bad access code', 0
24: err0D  DB      'Bad data', 0
25: err0E  DB      'Unknown cause', 0
26: err0F  DB      'Bad disk drive letter', 0
27: err10  DB      'Removing current directory is not allowed', 0
28: err11  DB      'Device is not the same', 0
29: err12  DB      'No more files available', 0
30: err13  DB      'Disk is write-protected', 0
31: err14  DB      'Unknown unit', 0
32: err15  DB      'Disk drive is not ready', 0
33: err16  DB      'Unknown command', 0
34: err17  DB      'Data (CRC) error', 0
35: err18  DB      'Bad structure length', 0
```

```

36: err19  DB      'Seek error', 0
37: err1A  DB      'Unknown type of medium', 0
38: err1B  DB      'Sector not found', 0
39: err1C  DB      'Printer is out of paper', 0
40: err1D  DB      'Disk write error', 0
41: err1E  DB      'Disk read error', 0
42: err1F  DB      'General failure', 0
43:
44: errors  DW      err00, err01, err02, err03, err04, err05, err06, err07
45:         DW      err08, err09, err0A, err0B, err0C, err0D, err0E, err0F
46:         DW      err10, err11, err12, err13, err14, err15, err16, err17
47:         DW      err18, err19, err1A, err1B, err1C, err1D, err1E, err1F
48:
49:         CODESEG
50:
51: ;----- From STRIO.OBJ
52: EXTRN   NewLine:proc, StrWrite:proc
53:
54:         PUBLIC  DiskErr
55:
56: %NEWPAGE
57: ;-----
58: ; DiskErr      Write disk error message to standard output
59: ;-----
60: ; Input:
61: ;      none (cf=1 following a DOS file operation)
62: ; Output:
63: ;      none (error message displayed)
64: ; Registers:
65: ;      ax, bp, bx, cx, dx, di, si changed
66: ;-----
67: PROC    DiskErr
68:     push    ds          ; Save segment registers
69:     push    es          ; modified by DOS fn 59h
70:     mov     ah, 59h     ; DOS Extended err fn num
71:     xor     bx, bx      ; Must be zero
72:     int     21h        ; Get extended error info
73:     pop     es          ; Restore segment registers
74:     pop     ds
75:
76:     cmp     ax, 1Fh     ; Is ax > 1Fh?
77:     jbe    @@10        ; Jump if ax <= 1Fh
78:     xor     ax, ax      ; Use "Unknown Cause" message
79: @@10:
80:     shl     ax, 1       ; Multiply ax by 2
81:     mov     bx, ax      ; Copy ax to bx
82:     mov     di, [errors+bx] ; Get address of string
83:     push    di          ; Save di temporarily
84:     call   NewLine      ; Start new display line
85:     mov     di, offset errString ; Address first part of message
86:     call   StrWrite     ; Write ERROR message
87:     pop     di          ; Restore address of message
88:     call   StrWrite     ; Write message to std out
89:     call   NewLine      ; Start a new display line
90:     ret
91: ENDP    DiskErr
92:
93:         END                ; End of module

```

Using DiskErr

To use the DISKERR module, add an `EXTRN DiskErr:Proc` command to your program. Then, assuming your program is named `MYSTUFF.ASM`, assemble and link to your library file with the commands:

```
tasm mystuff
tlink mystuff,,, mta
```

In your program code, after detecting an error from a file or disk directory DOS function, call `DiskErr` to display an appropriate message on screen. After this, you must take evasive action, ending the program or repeating a menu as suggested earlier. `DiskErr` doesn't do anything to solve the cause of an error—it just calls DOS for additional information and displays a message. Later in this chapter, you'll see examples of `DiskErr` at work. (For example, peek ahead to Listing 9.4, line 156.)

How DiskErr Works

In addition to performing a useful operation, the `DiskErr` procedure demonstrates an interesting assembly language technique for selecting elements from an array of variable-length items, in this case, an array of ASCIIZ strings. First, the strings are declared at lines 11–42, giving each string a unique label, `err01`, `err02`, etc. Then, a second array at lines 44–47 is created using each string label. Remember that labels are addresses; therefore, the errors array is simply a list of the 16-bit offset addresses of each variable-length character string.

Each entry in the errors array points to the error string associated with an error code value (0–1Fh), used as index values into errors. (See Figure 9.1.) After obtaining the extended error information from DOS (lines 68–74), the error code value is multiplied by 2 (because each errors entry is a 2-byte word), after which line 82 loads `di` with the address of the correct string. The rest of the procedure displays the string, prefacing the text with “** ERROR:.”

Figure 9.1.

An array of offset addresses (center) locates indexed elements (left) from an array of variable-length strings (right). Listing 9.1 uses this technique in the `DiskErr` procedure to select individual strings from an ASCIIZ string array.

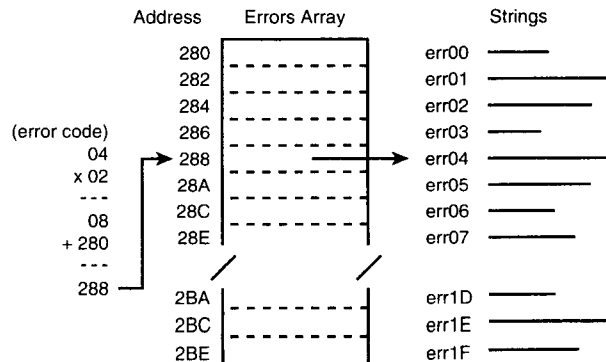

Creating New Files

As far as the program instructions are concerned, creating a new file is similar to opening an existing file. Assign the address of an ASCIIZ string containing the file's name and set *cx* to one of the values listed in Table 9.2. This value is placed in the file's attribute byte in the disk directory, affecting future operations on the file. Most of the time, set *cx* to 0. After completing these initialization steps, call function 03Ch to create the file:

```

DATASEG
fileName      DB      'C:\NEWFILE.TXT', 0
handle        DW      ?
CODESEG
mov     ax, @data          ; Initialize ds to address
mov     ds, ax             ; of data segment
mov     dx, offset fileName ; Address filename with ds:dx
mov     ah, 03Ch           ; DOS Create-File function number
xor     cx, cx             ; Specify normal file attributes
int     21h               ; Call DOS to create the file
jc      Error             ; Jump if an error is detected
mov     [handle], ax      ; Save handle for later

```

As usual, the carry flag indicates the success or failure of function 03Ch. If *cf* = 1, then *ax* holds an error code—3, 4, or 5, as listed in Table 9.1—otherwise, *ax* holds the file handle, saved by this example in a global variable *handle*.

NOTE

One danger with creating new files is that DOS does not check whether a file of the same name exists. If you create a file of an existing name, the old file's contents are erased or *truncated*, as some DOS references say. For this reason, it's wise to test if a file already exists *before* calling DOS function 03Ch to create a new file and possibly erasing existing data. Later in this chapter are examples of how to do this in assembly language.

Table 9.2. Create-File Attributes.

<i>Value</i>	<i>Meaning</i>
00	Normal file (most data files)
01	Read-only (write operations fail)
02	Hidden (invisible to DIR directory)
04	System file (better to use Hidden instead)

Reading the DOS Command Line

The traditional DOS program lets you enter one or more filenames, options, and other data on the command line. In other words, you want people to be able to type commands such as:

```
C>textsort /d file1.txt file2.txt
```

Presumably, this hypothetical command runs a text sorting program, which operates on file1.txt, writes the finished output to file2.txt, and uses an option /d to select a descending sort. Most high-level languages provide methods for reading parameters like these separated by spaces after the filename. But in assembly language there are no similar built-in mechanisms, and reading the DOS command-line parameters is more difficult. In this section, you'll assemble a program that adds this essential feature to your assembly language programs.

When COMMAND.COM loads an .EXE code file, it prepares a 256-byte block of memory called the *Program Segment Prefix* (PSP), which contains among other items any text entered on the DOS command line after the program name. These characters are called the *command tail*. Upon starting an .EXE program, both ds and es address the PSP, of which 128 bytes are devoted to storing the command tail. Unfortunately, this same area—from offset 80h to FFh—also serves as a temporary disk buffer for some DOS functions; therefore, the first job is to copy the text out of the PSP into a variable for safe keeping.

The actual number of characters in the command tail is stored at offset 0080h in the PSP. The first character (if there is one) is at 0081h. The last character is always a carriage return (0Dh). Listing 9.2, PARAMS.ASM, uses these facts to extract the command-line parameters from the PSP, saving the individual parameters as uppercase ASCII strings in a 128-byte buffer in the program's data segment. Like other modules in this book, PARAMS requires a host program before it will run. In a moment, I'll list a sample host. For now, assemble PARAMS and install the object code in your MTA.LIB library file with the commands:

```
tasm /zi params
tlib /E mta -+params
```

As always, ignore the error that PARAMS isn't in the library, which it won't be until you install it the first time. Repeat these commands if you later modify the listing. Remove the /zi option to conserve disk space, unless you plan to run programs with Turbo Debugger.

Listing 9.2. PARAMS.ASM.

```
1: %TITLE "Parse DOS Command-Line Params -- Copyright (c) 1989,1995 by Tom Swan"
2:
3:         IDEAL
4:
5:         MODEL    small
6:
7:
```

```

8: TailLen      EQU    0080h      ; Offset of param len byte
9: CommandTail  EQU    0081h      ; Offset of parameters
10:
11:
12:            DATASEG
13:
14: numParams    DW      ?          ; Number of parameters
15: params       DB      128 DUP (?) ; 128-byte block for strings
16:
17:
18:            CODESEG
19:
20:            PUBLIC ParamCount, GetParams, GetOneParam
21:
22: %NEWPAGE
23: ;-----
24: ; Separators    Private routine to check for blanks, tabs, and crs
25: ;-----
26: ; Input:
27: ;     ds:si addresses character to check
28: ; Output:
29: ;     zf = 1 (je) = character is a blank, tab, or cr
30: ;     zf = 0 (jne) = character is not a separator
31: ; Registers:
32: ;     al
33: ;-----
34: PROC    Separators
35:     mov    al, [si]              ; Get character at ds:si
36:     cmp    al, 020h             ; Is char a blank?
37:     je     @@10                 ; Jump if yes
38:     cmp    al, 009h             ; Is char a tab?
39:     je     @@10                 ; Jump if yes
40:     cmp    al, 00Dh             ; Is char a cr?
41: @@10:
42:     ret                          ; Return to caller
43: ENDP    Separators
44: %NEWPAGE
45: ;-----
46: ; ParamCount    Return number of parameters
47: ;-----
48: ; Input:
49: ;     none
50: ; Output:
51: ;     dx = number of command-line parameters
52: ;     Note: When calling GetOneParam, cx should be less
53: ;     than the value returned in dx by ParamCount
54: ; Registers:
55: ;     dx
56: ;-----
57: PROC    ParamCount
58:     mov    dx, [numParams]      ; Get value from variable
59:     ret                          ; Return to caller
60: ENDP    ParamCount
61: %NEWPAGE
62: ;-----
63: ; GetParams     Get DOS Command-Line Parameters

```

continues

Listing 9.2. continued

```

64: ;-----
65: ; Input:
66: ;     ds = Program Segment Prefix (PSP)
67: ;     es = Program's data segment
68: ;     Note: until you change it, ds addresses the PSP
69: ;     when all .EXE programs begin
70: ; Output:
71: ;     global params filled with ASCIIZ strings
72: ;     [numParams] = number of parameters
73: ;     ds = Program's data segment (es not changed)
74: ; Registers:
75: ;     al, bx, dx, si, di, ds
76: ;-----
77: PROC   GetParams
78:
79: ;----- Initialize counter (cx) and index registers (si,di)
80:
81:     xor    ch, ch                ; Zero upper half of cx
82:     mov    cl, [ds:TailLen]     ; cx = length of parameters
83:     inc    cx                    ; Include cr at end
84:     mov    si, CommandTail     ; Address parameters with si
85:     mov    di, offset params    ; Address destination with di
86:
87: ;----- Skip leading blanks and tabs
88:
89: @@10:
90:     call   Separators           ; Skip leading blanks & tabs
91:     jne    @@20                 ; Jump if not a blank or tab
92:     inc    si                    ; Skip this character
93:     loop   @@10                 ; Loop until done or cx=0
94:
95: ;----- Copy parameter strings to global params variable
96:
97: @@20:
98:     push   cx                    ; Save cx for later
99:     jcxz   @@30                 ; Skip movsb if count = 0
100:    cld                      ; Auto-increment si and di
101:    rep    movsb                ; copy cx bytes from ds:si to es:di
102:
103: ;----- Convert blanks to nulls and set numParams
104:
105: @@30:
106:    push   es                    ; Push es onto stack
107:    pop    ds                    ; Make ds = es
108:    pop    cx                    ; Restore length to cx
109:    xor    bx, bx                ; Initialize parameter count
110:    jcxz   @@60                 ; Skip loop if length = 0
111:    mov    si, offset params    ; Address parameters with si
112: @@40:
113:    call   Separators           ; Check for blank, tab, or cr
114:    jne    @@50                 ; Jump if not a separator
115:    mov    [byte ptr si], 0     ; Change separator to null
116:    inc    bx                    ; Count number of parameters

```

```

117: @@50:
118:     inc    si                ; Point to next character
119:     loop  @@40              ; Loop until cx equals 0
120: @@60:
121:     mov    [numParams], bx   ; Save number of parameters
122:     ret                    ; Return to caller
123: ENDP  GetParams
124: %NEWPAGE
125: ;-----
126: ; GetOneParam  Get one parameter address by number
127: ;-----
128: ; Input:
129: ;     cx = parameter number (0=first)
130: ;     Note: cx should always be less than the value
131: ;     returned in dx by ParamCount
132: ; Output:
133: ;     di = offset of ASCII string for this parameter
134: ; Registers:
135: ;     al, cx, di
136: ;-----
137: PROC  GetOneParam
138:     xor    al, al            ; Init search value to 0
139:     mov    di, offset params ; Address parameter strings
140:     jcxz  @@99              ; If number=0, jump to exit
141:     cmp    cx, [numParams]  ; Compare number with max
142:     jae   @@99              ; Exit if > maximum number
143:     cld                    ; Auto-increment di
144: @@10:
145:     scasb                   ; Scan for null terminator
146:     jnz   @@10              ; Repeat until found
147:     loop  @@10              ; Repeat for count in cx
148: @@99:
149:     ret                    ; Return to caller
150: ENDP  GetOneParam
151:
152:     END                    ; End of module

```

Running a PARAMS Demonstration

To understand how the PARAMS module works, it will help to assemble and run a test program. After this are details about how to use PARAMS in your own code. Save Listing 9.3 as SHOWPARAM.ASM and assemble, link, and run with the commands:

```

tasm /zi showparm
tlink /v showparm,,, mta
showparm param1 param2 param3

```

NOTE

The tlink command assumes that object-code modules PARAMS, BINASC, STRINGS, and STRIO from this and previous chapters are installed in MTA.LIB.

Listing 9.3. SHOWPARAM.ASM.

```

1: %TITLE "Display DOS Command-Line Params -- Copyright (c) 1989,1995 by Tom Swan"
2:
3:         IDEAL
4:
5:         MODEL    small
6:         STACK    256
7:
8:         DATASEG
9:
10: exCode      DB      0
11: string      DB      20 DUP (0)
12: s1          DB      'Number of parameters = ', 0
13:
14:         CODESEG
15:
16: ;----- From PARAMS.OBJ
17:         EXTRN   ParamCount:Proc, GetParams:Proc, GetOneParam:Proc
18:
19: ;----- From BINASC.OBJ, STRINGS.OBJ, STRIO.OBJ
20:         EXTRN   BinToAscDec:Proc, NewLine:Proc, StrWrite:Proc
21:         EXTRN   BinToAscHex:Proc, StrUpper:Proc
22:
23: Start:
24:         mov     ax, @data           ; Set ax to data segment
25:         mov     es, ax             ; Set es to data segment
26:         call    GetParams          ; Get parameters with ds = PSP
27:                                     ; Note: ds now equals es
28:
29: ;----- Display number of parameters
30:
31:         call    NewLine           ; Start new display line
32:         mov     di, offset s1      ; Address string
33:         call    StrWrite          ; Display string
34:         call    ParamCount        ; Get number of parameters
35:         mov     ax, dx             ; Assign count to ax
36:         mov     cx, 1             ; Specify at least one digit
37:         mov     di, offset string  ; Address work string
38:         call    BinToAscDec       ; Convert ax to decimal digits
39:         call    StrWrite          ; Display number
40:         call    NewLine           ; Start a new display line
41:
42:         xor     cx, cx             ; Initialize count to zero
43: @@10:
44:         call    ParamCount        ; Get number of parameters
45:         cmp     cx, dx             ; Compare counter to number
46:         je      Exit              ; Exit when cx = dx
47:         push   cx                 ; Save cx on stack
48:         call    GetOneParam       ; Get address of one parameter
49:         call    StrUpper          ; Convert to uppercase
50:         call    StrWrite          ; Display parameter string
51:         call    NewLine           ; Start a new display line
52:         pop    cx                 ; Restore saved cx value
53:         inc    cx                 ; Advance to next parameter
54:         jmp    @@10              ; Repeat until done

```

```

55: Exit:
56:      mov     ah, 04Ch           ; DOS function: Exit program
57:      mov     al, [exCode]       ; Return exit code value
58:      int     21h               ; Call DOS. Terminate program
59:
60:      END     Start             ; End of program / entry point

```

Using PARAMS

The PARAMS module (Listing 9.2) contains three procedures—ParamCount (45–60), GetParams (62–123), and GetOneParam (125–150)—that you can call to extract command-line parameters. As shown in SHOWPARM (Listing 9.3) at lines 24–26, start your program by setting `es` to the program's data segment and then immediately call `GetParams`:

```

mov     ax, @data           ; Set ax to data segment
mov     es, ax              ; Set es to data segment
call    GetParams           ; Get parameters with ds = PSP

```

Notice that this differs from the usual start-up sequence by *not* initializing `ds`. Because `ds` addresses the PSP when the program begins, you must not change `ds` before calling `GetParams`; otherwise, the procedure won't be able to find the command-tail characters. As an added benefit, `GetParams` assigns the value of `es` to `ds`, so there's no need to initialize `ds` after calling the procedure.

NOTE

Because of the effect that `GetParams` has on `ds`, you should never call this procedure more than once at the start of a program.

After these initializing steps, the individual parameters are available as ASCIIZ strings. Call `ParamCount` to set `dx` to the number of strings in memory. Because the first parameter is number 0, the maximum parameter number is always one less than the value `ParamCount` returns in `dx`—that is, unless `dx` is 0, in which case there aren't any parameters. To use an individual parameter string, assign the parameter number to `cx` and call `GetOneParam` as `SHOWPARM` demonstrates (line 48). This assigns the offset address of the ASCIIZ string for this parameter to `di`, which you can then pass to any procedure that operates an ASCIIZ string. For example, to open a file entered as the first parameter, you can start your code segment with:

```

mov     ax, @data           ; Set ax to data segment
mov     es, ax              ; Set es to data segment
call    GetParams           ; Get parameters with ds = PSP
call    ParamCount          ; Get number of parameters (dx)
or      dx, dx              ; Does number = 0?
jz      Exit                ; Exit if no parameters entered

```

At this point, the program ends if no parameters are entered. (A better program might also display a message, telling the user what to do next time.) If there is at least one parameter, the program continues, first locating the address of parameter string number 0, passing this address to DOS function 03Dh to open the file, and jumping to an error handler if an error is detected:

```
xor    cx, cx           ; Specify parameter number 0
call   GetOneParam     ; Get address of parameter
mov    dx, di          ; Address ASCIIZ string with ds:dx
mov    ah, 03Dh        ; Select DOS function 03Dh
int    21h             ; Call DOS to open the file
jc     Error           ; Jump if error detected
mov    [handle], ax    ; Else, save handle for later
```

You can also call `GetOneParam` to locate a parameter string and pass the address to any of the ASCIIZ string procedures in the `STRINGS` and `STRIO` modules. For example, to convert all parameters to uppercase, execute this code:

```
        call   ParamCount   ; Get number of parameters
@@10:  or     dx, dx          ; Does number = 0?
        jz     @@20         ; Jump if yes
        dec   dx            ; Else subtract 1 from number
        mov   cx, dx        ; Assign param number to cx
        call  GetOneParam   ; Get address of parameter string
        call  StrUpper      ; Convert string to uppercase
        jmp  @@10          ; Repeat until finished
@@20:
```

If you don't do this, parameters are stored in mixed uppercase and lowercase, exactly as typed on the DOS command line. You might take advantage of this fact by programming case-sensitive option letters. For example, the lowercase option `/s` could have a different effect from the uppercase `/S`.

How PARAMS Works

`GetParams` in the `PARAMS` module (Listing 9.2, lines 62–123) copies the command-tail characters into a global variable `params`, declared at line 15. Before doing this, the procedure skips any leading blanks or tabs (lines 89–93) entered after the filename. At this point, register `cx` equals the count of the number of characters in the parameter block. If this count is 0, line 99 skips the copy operation, carried out by the repeated string command at line 101. The rest of the procedure scans the copied characters looking for parameter separators—blanks, tabs, and carriage returns—converting these characters to nulls and consequently also converting the parameters to ASCIIZ strings.

NOTE

Because `GetParams` converts two adjacent blanks, tabs, and carriage returns to nulls, it's possible to introduce zero-length parameters accidentally by typing several spaces between parameters on the DOS command line. This does no harm—just ignore any null parameter strings returned by `GetOneParam`.

`GetOneParam` (125–150) scans the parameter block, looking for ASCII nulls and setting register `di` to the address of the requested string. The first part of the procedure checks that the parameter number in `cx` is in range, limiting the scan to the number of strings in memory. (If you specify a parameter number that is out of range, the procedure returns the address of the first parameter if there is one.) The code at lines 143–147 demonstrates an important assembly language technique for scanning a list of variable-length items. For reference, the code is repeated here:

```

        cld          ; Auto-increment di
@@10:   scasb        ; Scan for null terminator
        jnz  @@10   ; Repeat until found
        loop  @@10  ; Repeat for count in cx

```

First, `di` is cleared by `cld` so that `scasb` increments `di` automatically on each pass through the loop. (The code assumes that register `di` addresses the first parameter string to be scanned.) The `scasb` instruction compares the byte at `[es:di]` to the value in `al`, previously initialized to 0 (line 138). The result of `scasb` is to set the zero flag `zf` if the compared bytes match. If no match is found, the `jnz` instruction repeats the `scasb`; otherwise, the program continues to the `loop` instruction. At this point, `cx` equals the number of strings remaining to be scanned in the parameter block. The `loop` instruction subtracts 1 from `cx` and, if this does not make `cx` equal to 0, jumps to label `@@10::` starting another scan of the next string. When `cx` becomes 0, `di` addresses the first character of the requested string.

Returning to the `PARAMS` module, `ParamCount` (Listing 9.2, lines 45–60) simply returns the value of the global variable `numParams`. Another way to accomplish the same task is to declare the `ParamCount` variable public, adding the label to `PUBLIC` directive inside the data segment (line 20). If you make this change to `PARAMS.ASM`, you can remove the `ParamCount` procedure and use an `EXTRN` directive to refer to the external variable:

```
EXTRN numParams:Word
```

This tells the assembler that `numParams` addresses a `Word` variable in an external module to which you plan to link the host code. You can then read and write values to `[numParams]` just as though you had declared this variable in the main module. As you can see from the

listings in this book, I generally prefer to declare only procedures public, returning values via subroutines rather than allowing other modules to access global variables directly. This helps avoid possible conflicts that might occur if two procedures change the same value. But there's no technical reason to prevent modules from sharing data this way.

Reading and Writing Text Files

When learning how to process file data in any new language, a good place to start is with a simple program that copies one file character by character (or byte by byte) to a new file. With this basic shell available, it's a simple matter to insert code to modify characters on their way through the program. You can use this same design to write programs to convert characters to uppercase or lowercase letters, to count the number of words in a file, to encrypt data with a password, and to perform other useful operations.

Listing 9.4, KOPY.ASM, expects you to enter two filenames on the DOS command line. The program opens and reads the first file, creates a new file of the second filename, and copies every byte of the first file to the second. If a file of the second name already exists, the program asks for permission to remove the old file. If you don't enter exactly two parameters, the program displays instructions. These features represent the bare minimum design that programs of this nature probably should follow. Assemble and link KOPY with the commands:

```
tasm /zi kopy
tlink /v kopy,,, mta
```

Omit the `/zi` and `/v` options unless you want to test KOPY in Turbo Debugger. From the DOS command line, type `KOPY` and press Enter to display instructions. Or supply two filenames for KOPY to process. For example, to copy the file `ORIGINAL.TXT` to a new file named `NEWTEXT.TXT`, enter:

```
kopy original.txt newtext.txt
```

Listing 9.4. KOPY.ASM.

```
1: %TITLE "Copy Input to Output -- Copyright (c) 1989,1995 by Tom Swan"
2:
3:         IDEAL
4:
5:         MODEL    small
6:         STACK    256
7:
8: cr      EQU     13           ; ASCII carriage return
9: lf      EQU     10           ; ASCII line feed
10:
11:
12:         DATASEG
13:
```

```

14: exCode      DB      0
15:
16: inFile      DW      0      ; Input file handle
17: outFile     DW      0      ; Output file handle
18: oneByte     DB      0      ; Byte I/O variable
19:
20: prompt      DB      cr,lf,'Erase this file? (y/n) ', 0
21: diskFull    DB      cr,lf,'**ERROR: Disk is full', 0
22:
23: notes       DB      cr,lf,'KOPY copies all bytes from one file to a new file'
24:             DB      cr,lf,'as a demonstration of file read and write methods'
25:             DB      cr,lf,'in assembly language. The program can be modified'
26:             DB      cr,lf,'to process data on its way to the output file,'
27:             DB      cr,lf,'although this version makes no changes to the'
28:             DB      cr,lf,'information in the input file. Use the program by'
29:             DB      cr,lf,'supplying two filenames: the first name is the'
30:             DB      cr,lf,'file you want to read; the second is the new file'
31:             DB      cr,lf,'you want KOPY to create:',cr,lf
32:             DB      cr,lf,'KOPY <input file> <output file>',cr,lf, 0
33:
34:
35:             CODESEG
36:
37: ;----- From STRIO.OBJ
38:             EXTRN StrWrite:Proc, NewLine:Proc
39:
40: ;----- From DISKERR.OBJ
41:             EXTRN DiskErr:Proc
42:
43: ;----- From PARAMS.OBJ
44:             EXTRN GetParams:Proc, ParamCount:Proc, GetOneParam:Proc
45:
46: Start:
47:
48: ;----- Initialize and display notes if no parameters entered
49:
50:             mov     ax, @data      ; Set ax to data segment
51:             mov     es, ax         ; Set es to data segment
52:             call    GetParams      ; Get parameters with ds = PSP
53:             call    ParamCount     ; Get number of parameters (dx)
54:             cmp     dx, 2          ; Does count = 2?
55:             je      @@10          ; Continue if param count = 2
56:             mov     di, offset notes ; Address text with di
57:             call    StrWrite       ; Display notes
58:             jmp     Exit          ; Exit program
59:
60: ;----- Attempt to open the input file
61:
62: @@10:
63:             xor     cx, cx         ; Specify parameter number 0
64:             call    GetOneParam    ; Get address of parameter string
65:             mov     dx, di         ; Address filename with ds:dx
66:             xor     al, al         ; Specify read-only access
67:             mov     ah, 3Dh        ; DOS Open-file function
68:             int     21h           ; Open the input file
69:             jnc     @@20          ; Continue if no error
70:             jmp     Errors        ; Else jump to error handler
71:

```

Listing 9.4. continued

```

72: ;----- Check whether the output file already exists
73:
74: @@20:
75:     mov     [inFile], ax           ; Save input file handle
76:     mov     cx, 1                 ; Specify parameter number 1
77:     call    GetOneParam           ; Get address of parameter string
78:     mov     dx, di               ; Address filename with ds:dx
79:     call    FileExists           ; Does output file exist?
80:     jc     @e30                 ; Jump if file does not exist
81:     call    StrWrite             ; Display filename
82:     call    Confirm             ; Else confirm file removal
83:     je     @e30                 ; Continue if permission given
84:     jmp     Exit                ; Else exit program
85:
86: ;----- Attempt to create the output file
87:
88: @e30:
89:     mov     cx, 1                 ; Specify parameter number 1
90:     call    GetOneParam           ; Get address of parameter string
91:     mov     dx, di               ; Address filename with ds:dx
92:     xor     cx, cx                ; Specify normal attributes
93:     mov     ah, 3Ch              ; DOS Create-file function
94:     int     21h                 ; Create the output file
95:     jnc    @e40                 ; Continue if no error
96:     jmp     Errors              ; Else jump to error handler
97: @e40:
98:     mov     [outFile], ax        ; Save output file handle
99:
100: ;----- At this point, the input and output files are open and
101: ; their handles are stored at inFile and outFile. The next
102: ; step is to read from the input file and write each byte
103: ; to the output.
104:
105: @e50:
106:     mov     ah, 3Fh              ; DOS Read-file function
107:     mov     bx, [inFile]         ; Set bx to input file handle
108:     mov     cx, 1                 ; Specify one byte to read
109:     mov     dx, offset oneByte   ; Address variable with ds:dx
110:     int     21h                 ; Call DOS to read from file
111:     jnc    @e60                 ; Jump if no error detected
112:     jmp     Errors              ; Else jump to error handler
113: @e60:
114:     or     ax, ax                ; Check for end of input file
115:     jz     @e80                 ; ax=0=end of file; jump
116:     mov     ah, 40h              ; DOS Write-file function
117:     mov     bx, [outFile]        ; Set bx to output file handle
118:     mov     cx, 1                 ; Specify one byte to write
119:     mov     dx, offset oneByte   ; Address variable with ds:dx
120:     int     21h                 ; Call DOS to write to file
121:     jnc    @e70                 ; Jump if no error detected
122:     jmp     Errors              ; Else jump to error handler
123: @e70:
124:     or     ax, ax                ; Check for disk-full condition
125:     jnz    @e50                 ; Repeat for next byte
126:

```

```

127: ;----- Handle special case of disk-full condition
128:
129:     mov     di, offset diskFull      ; Address disk-full message
130:     call    StrWrite                 ; Display message
131:
132: ;----- Close the input and output files, which is not strictly
133: ;         required as ending the program via function 04Ch also closes
134: ;         all open files. Note: errors are handled only when closing
135: ;         the output file because no changes are made to the input.
136:
137: @@B0:
138:     mov     bx, [inFile]             ; Get input file handle
139:     mov     ah, 3Eh                 ; DOS Close-file function
140:     int     21h                     ; Close input file
141:     mov     bx, [outFile]           ; Get output file handle
142:     mov     ah, 3Eh                 ; DOS Close-file function
143:     int     21h                     ; Close output file
144:     jnc     Exit                    ; Exit if no errors detected
145:     jmp     Errors                   ; Else jump to error handler
146: Exit:
147:     mov     ah, 04Ch                ; DOS function: Exit program
148:     mov     al, [exCode]            ; Return exit code value
149:     int     21h                     ; Call DOS. Terminate program
150:
151: ;----- Instructions jump to here to handle any I/O errors, which
152: ;         cause the program to end after displaying a message.
153:
154: Errors:
155:     mov     [exCode], al             ; Save error code
156:     call    DiskErr                 ; Display error message
157:     jmp     Exit                    ; Exit program
158:
159: %NEWPAGE
160: ;-----
161: ; FileExists          Test whether a file already exists
162: ;-----
163: ; Input:
164: ;     ds:dx = address of ASCIIZ filename
165: ; Output:
166: ;     cf = 0 (jnc) = File of this name exists
167: ;     cf = 1 (jc)  = File of this name does not exist
168: ; Registers: ax, bx
169: ;-----
170: PROC     FileExists
171:     xor     al, al                   ; Specify read-only access
172:     mov     ah, 3Dh                 ; DOS Open-file function
173:     int     21h                     ; Call DOS to open the file
174:     jc     @@99                     ; Exit--file doesn't exist
175:     mov     bx, ax                  ; Copy handle to bx
176:     mov     ah, 3Eh                 ; DOS Close-file function
177:     int     21h                     ; Close the file
178:     clc                               ; Clear carry flag (file exists)
179: @@99:
180:     ret                               ; Return to caller
181: ENDP     FileExists

```

continues

Listing 9.4. continued

```

182: %NEWPAGE
183: ;-----
184: ; Confirm          Get Yes/No confirmation from user
185: ;-----
186: ; Input:
187: ;     none
188: ; Output:
189: ;     zf = 0 (jnz) = user typed N or n
190: ;     zf = 1 (jz)  = user typed Y or y
191: ; Registers: ax, cx, di
192: ;-----
193: PROC    Confirm
194:     mov  di, offset Prompt      ; Address prompt string
195:     call StrWrite              ; Display message
196:     mov  ah, 1                 ; DOS GetChar function
197:     int  21h                  ; Get user response
198:     cmp  al, 'Y'              ; Compare with Y
199:     je   @@99                 ; Exit if char = Y
200:     cmp  al, 'y'              ; Compare with y
201:     je   @@99                 ; Exit if char = y
202:     cmp  al, 'N'              ; Compare with N
203:     je   @@20                 ; Handle No response
204:     cmp  al, 'n'              ; Compare with n
205:     jne  Confirm              ; Repeat if not Y, y, N, n
206: @@20:
207:     cmp  al, '@'              ; Reset zero flag (zf=0)
208: @@99:
209:     ret                        ; Return to caller
210: ENDP    Confirm
211:
212:     END    Start              ; End of program / entry point

```

How KOPY.ASM Works

KOPY.ASM demonstrates how to process files one character at a time, copying the contents of one disk file to another. Because this requires numerous calls to DOS, the program runs more slowly than the DOS COPY and XCOPY commands, which perform similar duties. Although you can certainly use KOPY as a utility, the program is more useful as a shell for writing new programs that process all the characters in a file. For example, make a copy of KOPY.ASM to a new file named UPCASE.ASM (the finished file is already on disk) and insert code between lines 115 and 116 to modify the value stored in variable oneByte:

```

        mov  al, [oneByte]      ; Get input byte
        cmp  al, 'a'           ; Is byte >= 'a'?
        jb   @@Continue        ; Jump if byte < 'a'
        cmp  al, 'z'           ; Is byte <= 'z'?
        ja   @@Continue        ; Jump if byte > 'z'
        sub  al, 32             ; Convert Lower- to uppercase
        mov  [oneByte], al     ; Store char back in variable
@@Continue:

```

You'll probably also want to revise the instructions at label `notes` (lines 23–32). After making these changes, assemble and link the program with the commands:

```
tasm upcase
tlink upcase,,, mta
```

Lines 74–84 demonstrate how to check whether a file already exists, preventing a disaster that can easily occur if you accidentally specify the wrong output filename. Subroutine `FileExists` (lines 160–181) tries to open the file, returning the carry flag cleared if no errors are detected. Otherwise, the carry flag is set, indicating that this file can't be found. The procedure is careful to close the file if the open operation succeeds (lines 176–177). If the code didn't do this, repeated calls to `FileExists` could eventually cause DOS to run out of handles.

Another subroutine, `confirm` (lines 183–210), displays a message and waits for you to answer Y for Yes or N for No, confirming whether you want to erase an existing file.

After the preliminary steps of getting the filename parameters, checking for an existing file, and asking your permission to erase any old data—steps that occupy most of the program—lines 105–125 perform the actual copying, calling DOS function 03Fh to read from the input file and function 040h to write to the output file. Carefully study this section to see how errors are handled, calling `DiskErr` (line 156) in the `DISKERR` module. Also observe how lines 124–130 deal with the onerous disk-full error condition.

To read from an open file, pass to DOS function 03Fh the file handle in `bx` and the number of bytes to read in `cx`. Also assign to `ds:dx` the address of a variable at least `cx` bytes long. DOS reads from the file, deposits the data at the address you specify, and returns the carry flag cleared if no errors are detected. In this case, `ax` equals the number of bytes actually read, which may be less than the number you request. If the carry flag is set, then `ax` equals the error code. If no errors occur and `ax` equals 0, then there is no more data in the input file to read.

To write to a file, pass to DOS function 0040h the file handle in `bx` and the number of bytes to write in `cx`. Also assign the address of the source data to `ds:dx`. DOS writes up to `cx` bytes from `ds:dx`, returning the carry flag cleared if no errors occur. If the carry flag is set, then `ax` equals the error code. If no errors occur, then `ax` equals the number of bytes actually written. But, if `ax` is 0, then the disk is full, requiring special action.

Reading and Writing Data Files

Of course, text files are just a special case of a data file, which might contain any kind of information—name and address records, statistics, raw data from bar code readers, and so on. In assembly language programming, the contents of a file are unspecified, and it's up to you to write programs that choose correct methods for reading and writing data in various formats. Even so, you can use the same DOS functions discussed previously to process all files, regardless of the type of data they contain.

However, there is a big difference between reading and writing files one byte or character at a time and processing files that contain multibyte records. In most cases, programs need the ability to read and write such records in arbitrary order, for example, to allow editing record number 1,068 out of the 3,277 records stored on disk—without requiring the entire file to be copied to a new location. In general, doing this requires two new file I/O concepts, adding to the list at the beginning of this chapter:

- A seek operation positions the internal location pointer to the first byte of a record in the file.
- Reading or writing a specified number of bytes after a seek operation affects only one file record, leaving other data unchanged.

The concept of seeking in a file simply means to position DOS's internal file pointer, which tells DOS where to read or write data in each open file. The important rule to remember in assembly language file processing is that DOS always seeks to a byte position, no matter how many bytes each file record occupies. Therefore, to position the file pointer to the beginning of a multibyte record, the first job is to multiply the size of the record by the record number. (The first record in a file is number 0.) Assuming that the record size is stored in a variable named `recSize` and the record number is in `ax`, begin with:

```
mov    cx, [recSize]      ; cx = record size in bytes
mul    cx                 ; ax:dx ← ax * cx
```

The `mul` instruction multiplies the record number in `ax` by the record size in `cx`, storing the 32-bit result in `ax` (lower half) and `dx` (upper half). These values must then be transferred to `cx` (upper half) and `ax` (lower half) to accommodate the requirements of the DOS seek function 042h:

```
mov    cx, dx             ; cx ← MSW of result
mov    dx, ax             ; dx ← LSW of result
mov    ah, 042h          ; DOS Seek-file function
mov    al, 0              ; Seek from beginning of file
mov    bx, [handle]      ; Assign file handle to bx
int    21h               ; Position file pointer
jc     Error             ; Handle error
```

After performing these steps, the next read or write to the file occurs at the new position. To read a record into a variable named `Buffer`, you can execute:

```
mov    ah, 03Fh          ; DOS Read-file function
mov    bx, [handle]      ; Assign file handle to bx
mov    cx, [recSize]     ; cx = number of bytes to read
mov    dx, offset Buffer  ; ds:dx = destination address
int    21h               ; Read cx bytes from file
jc     Error             ; Handle error
```

Because reading (and writing) also advances the file pointer to the next record, you do not have to perform another seek if you want to read multiple records starting from a certain position. Writing an individual record is identical to the previous sample, but it calls func-

tion 040h instead of 03Fh. Also, some of the steps shown here for the sake of completeness may be unnecessary in practice. For example, `bx` already equals the file handle from the seek operation, so there's no need to reload the register.

You can also change the way the DOS seek function 042h operates. If `al = 0`, as it did in a previous sample, then the byte position value in `cx:dx` is considered to be absolute—in other words, relative to the beginning of the file. If `al = 1`, then the position value represents an offset relative to the current location. You can use this feature to advance to the next record:

```
xor    cx, cx                ; Zero upper half of value
mov    dx, [recSize]        ; cx:dx = size of record in bytes
mov    ah, 042h             ; DOS Seek-file function
mov    al, 1                ; Seek from current position
mov    bx, [handle]         ; Assign file handle to bx
int    21h                  ; Position file pointer
jc     Error                ; Handle error
```

If `al = 2`, the seek is performed backwards from the end of the file. This suggests a handy way to position the file pointer to the end of the file, perhaps in preparation for attaching new data at the end:

```
xor    cx, cx                ; Zero upper half of value
xor    dx, dx                ; Zero Lower half of value
mov    ah, 042h             ; DOS Seek-file function
mov    al, 2                ; Seek from end of file
mov    bx, [handle]         ; Assign file handle to bx
int    21h                  ; Position file pointer
jc     Error                ; Handle error
```

Reading the Disk Directory

Two DOS functions make reading directories easy. The basic plan is to call the first function to start scanning a directory and then repeatedly call the second function to scan the rest of the directory, finding all matches in the directory for *wild card strings* such as `*.*`, `*.PAS`, or `MYFILE.???`—identical to the filenames and wild cards you can type in a DOS `DIR` command. In assembly language programs, these strings are conveniently stored in ASCIIZ format.

Listing 9.5, `DR.ASM`, demonstrates how to read a disk directory, displaying a simple file listing similar in style to the result of the command `dir /w`. As with `DIR`, the program allows you to type an optional wild card string. For example, typing `dr *.asm` lists all the `.ASM` files in the current directory. Typing `dr` alone lists all files. Assemble and link `DR.ASM` with the commands:

```
tasm /zi dr
tlink /v dr,,, mta
```

The `tlink` command assumes that object-code modules `PARAMS`, `STRINGS`, and `STRIO` from this and previous chapters are stored in the `MTA.LIB` library file.

Listing 9.5. DR.ASM.

```

1: %TITLE "Display Disk Directory -- by Tom Swan"
2:
3:     IDEAL
4:
5:     MODEL    small
6:     STACK    256
7:
8: FileName      EQU    30      ; Offset to filename in dirData
9:
10:
11:     DATASEG
12:
13: exCode        DB    0
14:
15: defaultSpec   DB    '*.*', 0      ; Default ASCIIIZ wild card
16: DTaseg        DW    ?            ; Segment for DTA
17: DTAofs        DW    ?            ; Offset for DTA
18: dirData       DB    43 DUP (?)   ; Holds one directory entry
19:
20:
21:     CODESEG
22:
23: ;----- From PARAMS.OBJ
24: EXTRN  GetParams:Proc, GetOneParam:Proc, ParamCount:Proc
25:
26: ;----- From STRINGS.OBJ, STRIO.OBJ
27: EXTRN  StrLength:Proc, StrWrite:Proc, NewLine:Proc
28:
29: Start:
30:     mov    ax, @data                ; Set ax to data segment
31:     mov    es, ax                    ; Set es to data segment
32:     call  GetParams                  ; Get parameters with ds = PSP
33:     call  NewLine                    ; Start new display line
34:     call  ParamCount                 ; Get number of parameters (dx)
35:     mov    di, offset defaultSpec    ; Address default search string
36:     or     dx, dx                    ; Does dx = 0?
37:     jz    @@10                       ; Jump if dx (num params) = 0
38:     xor    cx, cx                    ; Else specify param #0
39:     call  GetOneParam                ; Get address of parameter
40: @@10:
41:     mov    bx, offset Action         ; Address action subroutine
42:     call  DirEngine                  ; Scan directory entries
43: Exit:
44:     call  NewLine                    ; Start new display line
45:     mov    ah, 04Ch                  ; DOS function: Exit program
46:     mov    al, [exCode]              ; Return exit code value
47:     int    21h                       ; Call DOS. Terminate program
48:
49: %NEWPAGE

```

```

50: ;-----
51: ; DirEngine      Directory scan "engine"
52: ;-----
53: ; Input:
54: ;     cs:bx = address of subroutine
55: ;     ds:di = address of ASCIIZ search string (e.g. *.ASM)
56: ; Output:
57: ;     routine at cs:bx called for each directory entry match
58: ; Registers:
59: ;     ax, cx, dx + any changed in action subroutine at cs:bx
60: ;-----
61: PROC      DirEngine
62:
63: ;----- Get current Disk Transfer Address (DTA) and save
64:
65:     push   es                ; Save registers modified
66:     push   bx                ; by DOS 2Fh function
67:     mov    ah, 2Fh           ; DOS Get DTA function
68:     int    21h              ; Get current DTA
69:     mov    [DTAseg], es     ; Save segment address
70:     mov    [DTAofs], bx     ; Save offset address
71:     pop    bx                ; Restore registers
72:     pop    es
73:
74: ;----- Set new DTA to global 43-byte dirData variable
75:
76:     mov    dx, offset dirData ; Address variable with ds:dx
77:     mov    ah, 1Ah          ; DOS Set DTA function
78:     int    21h              ; Set new DTA
79:
80: ;----- Scan directory for matches to string at ds:dx
81:
82:     mov    ah, 4Eh           ; DOS Search-first function
83:     mov    cx, 10h          ; Attribute--files + subdirs
84:     mov    dx, di           ; Address string with ds:dx
85:     jmp    short @@20        ; Skip next assign to ah
86: @@10:
87:     mov    ah, 4Fh           ; DOS Search-next function
88: @@20:
89:     int    21h              ; Search first/next entry
90:     jc     @@99              ; Exit on error or done
91:     call   bx                ; Call Action subroutine
92:     jmp    @@10              ; Repeat until done
93:
94: ;----- Restore original DTA address
95:
96: @@99:
97:     push   ds                ; Preserve current ds
98:     mov    ds, [DTAseg]     ; Assign old DTA address
99:     mov    dx, [DTAofs]     ; to ds:dx
100:    mov    ah, 1Ah          ; DOS Set-DTA function
101:    int    21h              ; Reset to old DTA
102:    pop    ds                ; Restore ds
103:    ret                      ; Return to caller
104: ENDP      DirEngine
105: %NEWPAGE

```

Listing 9.5. continued

```

106: ;-----
107: ; Action      Called for each directory entry "hit"
108: ;-----
109: ; Input:
110: ;     dirData = directory entry (as returned by DOS)
111: ; Output:
112: ;     one file/subdirectory name displayed
113: ; Registers:
114: ;     ah, dl, cx, di
115: ;-----
116: PROC      Action
117:         mov     di, offset dirData + FileName
118:         call    StrWrite
119:         call    StrLength
120:         sub     cx, 16
121:         neg     cx
122: @@10:
123:         mov     ah, 2
124:         mov     dl, ' '
125:         int     21h
126:         loop   @@10
127:         ret                               ; Return to caller
128: ENDP     Action
129:
130:         END     Start                    ; End of program / entry point

```

How DR Works

DR illustrates a couple of new assembly language techniques. Line 41 assigns the offset address of a subroutine to register `bx`, passing this value to `DirEngine` (lines 50–104). Then, at line 91, `DirEngine` calls this subroutine with the instruction:

```
call     bx                ; Call routine at cs:bx
```

There is no difference between this kind of a subroutine call and the more familiar variety where you specify the routine's label as an immediate value. But the `bx` method allows you to pass different subroutine addresses to another routine. In this program, the technique allows you to change the action taken for each directory match or "hit." As this demonstrates, writing routines to accept the address of another routine as an input parameter is a valuable technique.

Most of the `DirEngine` subroutine is concerned with preserving and setting the Disk Transfer Address (DTA), the memory location that DOS uses for some nonhandle file operations. When reading directories, DOS copies individual directory entries into a 43-byte DTA, which you must provide. Study the comments in `DirEngine` and be sure you understand how the code saves and preserves the current DTA—not strictly required in this example, as ending the program makes restoring the original DTA unnecessary. However, in a larger program, it's a good idea to preserve the DTA as shown here.

The Action subroutine (lines 106–128) displays one filename from the DTA filled in by DirEngine. Figure 9.2 illustrates the format of the directory fields in this 43-byte variable. Here, the program needs only the one field at offset 30 decimal, locating the first byte of an ASCIIZ string containing the entry's filename. Displaying this string requires setting `di` to the offset address inside the `dirData` DTA variable, calculated by adding the known offset to the filename (30) plus the offset address of `dirData`:

```
mov    di, offset dirData + FileName
```

Then, `StrWrite` (from `STRIO.OBJ`) displays the filename. To align the columns, three instructions then calculate how many blanks are required between the last character of each filename and the start of the next column:

```
call   StrLength    ; Find length of filename string
sub    cx, 16        ; Subtract length-16
neg    cx           ; Find absolute value (two's complement)
```

Figure 9.2.
Directory entry format.

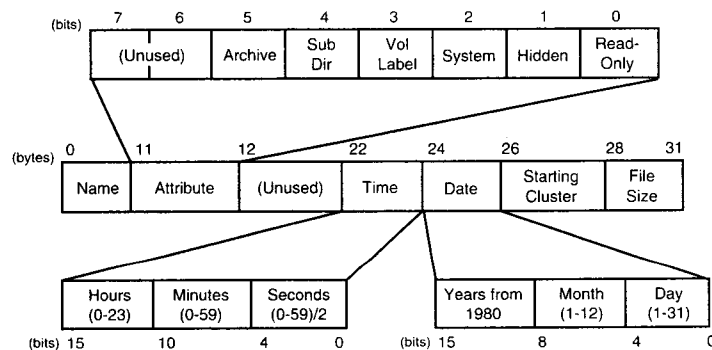

There are other ways to set `cx` to the number of blanks required to flesh out a variable-length column, but this trick usually works. First, subtract the length of the variable-length part (the filename's length in this case) from the fixed column width, 16 here. Assuming that the variable length part is less than 16, this produces a negative number in two's complement form. Negate this result to find the absolute value—the number of blanks to write to align the cursor to the next column to the right. The reason for performing the subtraction this way is that you cannot write:

```
sub    16, cx      ; ???
```

which gives you an “Illegal Immediate” error. The 8086 `sub` instruction cannot subtract a register from a literal value—it can only subtract literal values from registers and other values stored in memory. Following `sub` with `neg` is one way to circumvent this restriction.

Summary

File handles first appeared in DOS version 2.0, replacing the older and no longer recommended FCB methods for disk file I/O. Handles simplify disk-file processing by eliminating the need to create and maintain FCB records, which contain information that is seldom of direct use to programs.

Files must be opened to make the data they contain available to programs. Creating a new file erases any data stored in a file of the same name. Memory buffers store data on its way to and from disk—you should never assume that a disk write operation actually transfers bytes to disk. Closing a file flushes (writes) any buffered data to disk, updates the disk directory, and releases the file handle. The current location points to the place in a file where the next read or write operation will occur. These are important and universal file I/O concepts to learn.

Programs can open up to 20 files, as long as the total specified in a CONFIG.SYS *files=n* command is not exceeded, up to a maximum of 255 handles for all active programs. Because DOS reserves handles 0 to 4 for standard I/O, programs are normally limited to opening 15 files simultaneously. You can slightly increase this limit by closing one or more of the five standard handles.

Because data written to disk is buffered in memory, the only reliable method for ensuring that all information is saved on disk is to close the file. The DOS “flush buffer” command is inadequate for this task. Ending programs with DOS function 04Ch automatically closes all open files; therefore, programs may safely end with files left open.

Disk errors must be carefully handled in assembly language, which, unlike most high-level languages, has no built-in features to detect errors and take appropriate actions. When writing to disk, it’s especially important to handle a disk-full condition, which DOS doesn’t flag as an error. Extended error information is also available, either by using the DISKERR module in this chapter or by calling DOS directly. The DISKERR module also demonstrates how to create an array of variable-length items, such as character strings.

The traditional DOS program allows you to type parameters on the command line, passing options, filenames, and other information to programs. You can use the PARAMS module in this chapter to convert parameters into easy-to-use ASCII strings.

Processing text files one character at a time is a simple matter of calling DOS functions to read input and write output. You can also use the same functions to process multibyte records in other kinds of data files. With the help of the DOS seek function, you can operate on individual records without disturbing other data in the file.

Another pair of DOS functions let you read disk directories, matching filenames with wild cards such as *.TXT. Each entry from the directory is loaded by DOS into a memory area called the DTA, from which you can extract directory information.

Exercises

- 9.1. What does closing a file do?
- 9.2. What does opening a file do?
- 9.3. Write a subroutine to prompt for a filename and, unless the user simply presses Enter, to open the file (if it exists).
- 9.4. Write a subroutine to flush any in-memory data to disk. The subroutine input should include the filename and a file handle.
- 9.5. Write a subroutine to read a record of n bytes by number from an open data file.
- 9.6. Write a subroutine to return the next record *past* the current record of n bytes from an open data file.
- 9.7. Write a subroutine to return the zero flag set if an option letter such as `-d` or `/Z` is located among the parameters entered on the DOS command line.
- 9.8. Write a routine to separate a DOS filename from its extension, returning a single string exactly 12 characters long. (For examples of this format, type `DIR /w` at the DOS prompt.) Modify DR to use the new routine to display filenames in this new format.
- 9.9. What instructions could you insert into the KOPY.ASM program shell to remove all the control codes (except for carriage returns and line feeds) from a text file? (As an alternative, you can replace control codes with blanks.)
- 9.10. Modify a copy of DR.ASM to list all the .COM and .EXE code files in the current disk directory.

Projects

- 9.1. Rewrite the PARAMS module to eliminate null parameter strings if any are detected in the command tail.
- 9.2. Write a new version of KOPY.ASM that reads n bytes from a file into a large program variable of a suitable size, for example, 256 or 512 bytes long. Then devise a subroutine to return characters from your buffer. What does this do to the speed of KOPY?
- 9.3. Describe how you might design a program to operate simultaneously on more than the maximum of 15 or so files allowed by DOS. What data structures and variables does the program need? What are the probable subroutines required?
- 9.4. Convert DR.ASM to a library module that any program can use.

- 9.5. Because command-line parameters are usually short, the 128-byte `params` buffer in Listing 9.2, `PARAMS.ASM`, is rarely filled to the brim. Come up with a plan to limit the size of this buffer to only as much space as needed to store the command tail, reducing space currently wasted at the end of this buffer.
- 9.6. Write subroutines to read and write ASCIIZ strings a line at a time, recognizing the carriage-return and line-feed control codes as line separators in a text file.

10

CHAPTER

Interrupt Handling

- We Interrupt This Program..., 370
- Writing Interrupt Service Routines, 370
- Maskable Versus Nonmaskable Interrupts, 371
- Interrupt Vectors and the 8259 Chip, 372
- Why hlt Doesn't Halt, 376
- Servicing Interrupts, 377
- Tapping into the PC Timer Interrupt, 380
- The End-of-Interrupt Command, 384
- Interrupts and Stacks, 385
- Using int and into Instructions, 388
- Trapping Divide-Fault Interrupts, 389
- Fixing a Divide Fault, 389
- Installing a Divide-Fault Handler, 390
- Installing TSR Code in Memory, 395
- Interrupt-Driven Serial Communications, 397
- Debugging with Interrupt: 414
- Single Stepping, 414
- Summary, 421
- Exercises, 422
- Projects, 422

We Interrupt This Program...

An interrupt is an event that temporarily halts a running program, executes a subroutine called an *interrupt service routine* (ISR), and then restarts the original program as though nothing had happened. This action resembles the interruption of a television program for an “important message,” resuming the normal broadcast after an announcer reads the news.

In computer programming, interrupts help to eliminate *polling*—repeatedly examining peripheral devices such as keyboards, printers, and light pens to see whether they require input or whether they have output ready for processing. Instead, such devices may generate an interrupt signal, which automatically runs an appropriate ISR, servicing the device’s needs upon demand. By this action, devices can use interrupts to run their own personal programs independently of other software actions. In 8086 programming, this classic definition of interrupts is extended with two kinds of interrupt signals:

- External interrupts
- Internal interrupts

External interrupts occur when a device attached to the processor generates an interrupt signal. *Internal interrupts* occur from within the processor in two ways: as the result of software `int` instructions and from certain conditions such as dividing by 0 with `div`, which generates a default interrupt signal (called an *exception*) for this error condition. In addition, internal `int` interrupts—also called *software interrupts*—can simulate the external kind, a useful technique for debugging external ISRs.

Writing Interrupt Service Routines

An ISR can do anything that other assembly language code can do. An ISR is nothing more than a special kind of subroutine, called by the interrupt actions just described. Putting aside a few of the more subtle issues for the moment, there are four basic rules to follow when coding your own interrupt service routines:

- Save all registers at the beginning of the routine
- Execute `sti` to process interrupts from within the ISR
- Restore all registers at the end of the routine
- Execute `iret` as the last instruction

External interrupts may occur at any time; therefore, it’s vital that an external ISR makes no changes to any register values. There’s no telling which registers might be in use when an external interrupt occurs; as a consequence, forgetting to save and restore a register changed inside the service routine is likely to have disastrous effects on other software. Internal ISRs

may change register values because programs have more control over when this kind of interrupt can occur. (Internal ISRs operate similarly to subroutines.) Execute an `sti` instruction, setting the interrupt-enable flag (`if`), if you want other interrupts to be able to interrupt the current service routine. Otherwise, new interrupts will not be recognized until your routine executes an `iret` (Interrupt Return) instruction, which must be last in every interrupt service routine.

NOTE

Although interrupts may occur at any time, they are recognized by the processor only *between* other instructions. In other words, if an interrupt occurs during a `mul` instruction, which might take as long as 139 machine cycles to complete, the `mul` will be completed before the interrupt is recognized. As a result of this potential delay, and because most instructions take differing numbers of cycles to execute, even the most regular interrupt signals are likely to be processed at irregular time intervals. Repeated string instructions such as `rep movsb` can be interrupted between repetitions.

Maskable Versus Nonmaskable Interrupts

The 8086 processor family has two input pins that can be attached to external interrupt-generating devices. These pins, or input lines, are:

- Maskable Interrupts (INTR)
- Nonmaskable Interrupts (NMI)

The INTR line is used by most interrupt-generating devices to signal the processor that the device needs servicing. The `cld` and `sti` instructions affect interrupts coming in on this line. Executing `cld` prevents—or *masks*—the processor from recognizing INTR interrupts. Executing `sti` allows the processor to again recognize INTR interrupt signals. Neither of these two instructions has any effect on the second interrupt line NMI, which cannot be disabled. Usually, NMI is reserved for disaster control, executing code when a power drop is detected, halting the system if a memory error occurs, and so forth. In the original IBM PC design, NMI handles memory parity errors, which occur if a bad memory bit is detected. Today, other devices share NMI, complicating NMI interrupt servicing.

The `sti` and `cld` instructions have no effect on software interrupts—those generated by an `int` instruction in a program or by the occurrence of a divide fault and similar conditions. Regardless of the setting of `if`, you can always execute `int` to force an interrupt service routine to run.

NOTE

Some programmers are mistaken in their belief that NMI can be disabled. It can't. However, in the IBM PC, it's possible to disable other circuits that generate interrupt signals to the NMI line into the processor, thus preventing NMI from occurring. On the IBM XT and true compatibles, you might be able to mask NMI by writing 00h (disable) or 080h (enable) to output port 0A0h. This may not have the effect you want, however, because this does not prevent other programs from enabling NMI after you disable them. Also, be aware that some peripheral interface circuits use NMI for their own purposes.

Interrupt Vectors and the 8259 Chip

With only two interrupt lines INTR and NMI, you might think that the 8086's interrupt possibilities are severely limited. But, with the help of another chip, Intel's 8259 *Programmable Interrupt Controller* (PIC), IBM PCs can service up to eight interrupt-generating devices. (IBM ATs cascade a second PIC to service even more devices. Most modern PCs are similar to this design.) Each device is assigned one PIC level number from 0 to 7 (up to 15 on ATs) with lower numbers having higher priorities. This means that, if two interrupts occur simultaneously, the 8259 controller gives priority service to the device with the lowest number. Table 10.1 lists the devices associated with each PIC level. Level 2 serves as a channel between two cascaded 8259s on AT computers. Because NMI is also externally generated, it's listed in the table, although this line is not attached to an 8259 controller.

Table 10.1. External Hardware Interrupts.

<i>PIC Level</i>	<i>Interrupt Number</i>	<i>Device</i>
0	08h	Timer (software clock)
1	09h	Keyboard
2	0Ah	To slave 8259
3	0Bh	Secondary serial I/O (COM2)
4	0Ch	Primary serial I/O (COM1)
5	0Dh	Fixed (hard) disk
6	0Eh	Removable (floppy) disk
7	0Fh	Parallel printer
8	070h*	Hardware clock
9	071h*	To Master 8259 Level 2

<i>PIC Level</i>	<i>Interrupt Number</i>	<i>Device</i>
10	072h*	-
11	073h*	-
12	074h*	-
13	075h*	Numeric coprocessor
14	076h*	Fixed (hard) disk
15	077h*	-
NMI	02h	Memory parity

*IBM AT and compatibles only.

As you can see from Table 10.1, each PIC level is associated with a second value called an *interrupt number*—also called an *interrupt type* or an *interrupt level*—ranging from 08h to 0Fh on PC-, PcJr-, and XT-type computers with an additional eight levels on ATs. This dual-numbering system for external interrupts confuses many people. Remember that the PIC level refers to the actual pin on the 8259 controller to which the device is attached. The interrupt number identifies the ISR that runs when this device requires servicing. In programming, you can ignore the PIC level and refer to interrupts by their interrupt numbers instead.

Table 10.2 lists the full range of interrupt numbers assigned in typical PC/XT-type computers. Except for the first eight external interrupts from Table 10.1, which are repeated in this table, most of the interrupts from this complete set are of the internal software variety. Regardless of the kind of interrupt, every interrupt number is associated with a unique *interrupt vector*, stored at the locations listed in the center of Table 10.2

Table 10.2. Software Interrupt Numbers and Vectors.

<i>Interrupt Number</i>	<i>Vector Location</i>	<i>Purpose</i>
000h	0000h	Divide faults
001h	0004h	Single step (trap)
002h	0008h	Nonmaskable interrupt (NMI)
003h	000Ch	Breakpoint
004h	0010h	Overflow
005h	0014h	Print screen
006h	0018h	*
007h	001Ch	*

Table 10.2. continued

<i>Interrupt Number</i>	<i>Vector Location</i>	<i>Purpose</i>
008h	0020h	Timer (software clock)
009h	0024h	Keyboard
00Ah	0028h	*
00Bh	002Ch	Secondary serial I/O (COM2)
00Ch	0030h	Primary serial I/O (COM1)
00Dh	0034h	Fixed (hard) disk
00Eh	0038h	Removable (floppy) diskette
00Fh	003Ch	Parallel printer
010h	0040h	Video
011h	0044h	Equipment check
012h	0048h	Memory check
013h	004Ch	disk
014h	0050h	RS-232I/O
015h	0054h	Cassette (PC), Aux (AT)
016h	0058h	Keyboard
017h	005Ch	printer
018h	0060h	BASIC in ROM
019h	0064h	Bootstrap
01Ah	0068h	Time of day
01Bh	006Ch	Keyboard Ctrl-Break
01Ch	0070h	User-installed timer routine
01Dh	0074h	Video initialization
01Eh	0078h	Disk parameters printer [†]
01Fh	007Ch	Bit-mapped characters pointer [†]
020h-03Fh	0080h-00FCh	Reserved for DOS
040h-06Fh	0100h-01BCh	Various
070h	01C0h	Hardware clock
071h	01C4h	*
072h	01C8h	*
073h	01cch	*

<i>Interrupt Number</i>	<i>Vector Location</i>	<i>Purpose</i>
074h	01D0h	*
075h	01D4h	Numeric coprocessor
076h	01D8h	Fixed (hard) disk
077h	01dch	*
078h-0FFh	01E0h-03FCh	Various

*Reserved or not used.
 †Not an interrupt service routine.

An interrupt vector is simply a pointer—a 32-bit (4-byte) address with segment and offset values—stored in the lowest addresses of memory, from 0000:0000 through 0000:30FF. Each vector locates the start of the interrupt service routine associated with one interrupt number, ranging from 00 to FFh, for a total of up to 256 software and hardware interrupts in a typical PC design. When an external interrupt signal is generated by one of the devices listed in Table 10.1, the 8259 controller activates the processor's INTR line, waits for an acknowledgment (which occurs automatically), and then sends the appropriate interrupt number to the processor. The processor uses this interrupt number to pick out the right vector from low memory and calls the ISR. A similar action occurs when a program calls a software interrupt with an `int` instruction or when an internal interrupt is generated as the result of a divide fault or similar condition. For both external and internal interrupts, several events occur after the processor receives the interrupt number:

- The flags are pushed onto the stack
- The `if` and `tf` flags are cleared
- the `ip` and `cs` registers are pushed onto the stack
- The interrupt vector is copied to `cs:ip`

The last step of this process causes the interrupt service routine to begin running at the vector address stored in memory for the interrupt number, as listed in Table 10.2. By changing one or more of these vectors, you can insert your own interrupt service routines in place of the default code that services interrupts on your system. You can also chain your interrupt services to existing ISRs, a method that you can use to recognize certain key presses as activation commands, allowing other key presses to pass through unchanged. When the ISR is finished servicing the interrupt, it executes an `iret` instruction, which causes these actions to occur:

- The `cs` and `ip` registers are popped from the stack
- The flags are popped from the stack

The first of these actions causes the interrupted program to continue running normally. The second step restores any flags that may have been changed by instructions inside the ISR. Because the flags are automatically saved and restored this way and because a hardware interrupt is serviced only if the `if` flag is set (via an `sti` instruction, for example), you never need to execute `sti` inside an ISR to allow future interrupts to be serviced after the ISR is finished—a common misconception. The original flags are pushed onto the stack before `if` and `tf` are cleared by the processor; therefore, if `if` is set beforehand, it will be set after `iret` executes. You need to execute `sti` in your service routine only if you want interrupts to be recognized *during* execution of the ISR.

When you want an ISR to return flag values—for example, as often done by the DOS function `int 21h` instruction—you have two choices: Change the flag values on the stack before executing `iret` or remove the flags from the stack and execute a plain `ret` instead. Remember that an interrupt service routine is just a special kind of subroutine; therefore, to pass back flags changed inside the routine, you can use code such as:

```
retf    2           ; Return and discard 2 stack bytes
```

This returns from the ISR and, after popping the code segment and instruction pointer registers from the stack, removes 2 bytes from the stack. Those 2 bytes hold the flag values that were pushed onto the stack when the ISR was activated. Do this only for internal ISRs, which programs call like subroutines. By discarding the flags saved on the stack by the processor after acknowledging an interrupt, you effectively convert the ISR to a plain subroutine, which can end in `ret`. You can then use `call` instructions to execute the same code, starting from a different entry point, of course. Although you won't often use this trick, it's useful to understand that an ISR is just a special kind of subroutine, and it's up to you to decide what the code does and how it returns control to its callers.

Why `hlt` Doesn't Halt

Closely related to interrupt programming, the `hlt` instruction behaves differently than you might think. Upon executing `hlt`, the 8086 processor pauses, effectively stopping the program at this location. At this time, if interrupts are enabled, an interrupt signal to the processor's `INTR` line is recognized as usual, causing the interrupt service routine to execute and, thus, breaking out of the halted condition. When the ISR ends, processing continues with the instruction following the `hlt`. In other words, `hlt` doesn't really halt—it waits for an interrupt to occur. If interrupts are disabled, however, `hlt` can indeed lock up the computer system by preventing recognition of `INTR` signals. Therefore, to bring the 8086 to its knees, you might be able to execute:

```
cli     ; Disable interrupts by clearing if  
hlt     ; Halt until interrupt, which can't occur!
```

After these two instructions, only two events can unlock the processor: a RESET or an NMI, both of which ignore the setting of *if*. (RESET is an input line to the processor, which may not be connected to a reset button on your system. Many early PCs did not have reset buttons.)

A more practical use for *hlt* is to synchronize programs to external events, pausing until an interrupt signal from a specific device occurs. The key to this idea is the *sti* instruction, which sets the *if* flag, enabling INTR interrupts to be recognized. However, this recognition occurs only after the *next* instruction following the *sti*; therefore, to synchronize a program with an external interrupt, you should never write:

```
sti    ; Allow interrupts to occur
cli    ; Disable interrupts ???
```

Because interrupts are recognized only after the instruction following *sti*, if that instruction disables interrupts, then even the sneakiest interrupt signal will not have enough time to sneak through. The correct way to synchronize a program to an external event is with code such as:

```
cli    ; Disable interrupts
sti    ; Enable interrupts following next instruction
hlt    ; Pause for an INTR interrupt to occur
cli    ; Disable interrupts again (optional)
```

If interrupts are already disabled, the first *cli* is not needed. The second *cli* is needed only if you want to prevent additional interrupts from occurring. By following *sti* with *hlt*, your program is assured of continuing only upon receipt of an external interrupt INTR signal, generated, for example, by a key press or a character received at a serial input port.

Servicing Interrupts

ISR code follows the same basic design for external and internal interrupts. This section demonstrates how to write ISRs to handle interrupts and also explores a few subtleties of interrupt handling in 8086 assembly language.

Listing 10.1, SLOWMO.ASM, taps into the PC's free-running timer interrupt to add regular pauses to a program, slowing code execution to a crawl. This can be a useful device for debugging a fast program when the action speeding by is too chaotic to see. The program also demonstrates the correct way to handle interrupts that come in via the 8259 PIC chip. When the interrupt is from the PC timer interrupt, special care is required to avoid disrupting the system clock. SLOWMO serves as a platform for illustrating these subjects. Assemble and link SLOWMO with your MTA.LIB file using the commands:

```
tasm slowmo
tlink slowmo,,, mta
```



Listing 10.1. SLOWMO.ASM.

```
1: %TITLE "Slow Motion Interrupt -- Copyright (c) 1989,1995 by Tom Swan"
2:
3:         IDEAL
4:
5:         MODEL    small
6:         STACK    256
7:
8: delay   EQU      0010h           ; Amount of delay
9: cr      EQU      13             ; ASCII carriage return
10: lf     EQU      10             ; ASCII line feed
11: BIOSData EQU     040h           ; BIOS data segment address
12: LowTimer EQU     006Ch         ; Address of low timer word
13: PIC8259 EQU     0020h         ; 8259 PIC chip port address
14: EOI    EQU     0020h         ; End of interrupt value
15:
16:         DATASEG
17:
18: exCode   DB      0
19: string   DB      'This is a test of the timer', cr, lf
20:         DB      'slow-mo interrupt handler', cr, lf, 0
21: timerSeg DW      ?             ; Saved vector for original
22: timerOfs DW      ?             ; Int 1Ch ISR
23:
24:
25:         CODESEG
26:
27: ;----- From STRIO.OBJ, KEYBOARD.OBJ
28: EXTRN   StrWrite:proc, KeyWaiting:proc
29:
30: Start:
31:         mov     ax, @data           ; Initialize DS to address
32:         mov     ds, ax             ; of data segment
33:         mov     es, ax             ; Make es = ds
34:
35:         mov     [word cs:difference],delay ; Set amount of delay
36:
37:         push    es                 ; Save es register
38:         mov     ax, 351Ch          ; Get interrupt 1C vector
39:         int     21h               ; Call DOS for vector
40:         mov     [timerSeg], es     ; Save segment value
41:         mov     [timerOfs], bx     ; Save offset value
42:         pop     es                 ; Restore es
43:
44:         push    ds                 ; Save ds register
45:         mov     ax, 251Ch          ; Set interrupt 1C vector
46:         push    cs                 ; Make ds = cs to address
47:         pop     ds                 ; the new ISR, placing full
48:         mov     dx, offset SlowMo ; address into ds:dx
49:         int     21h               ; Set new interrupt vector
50:         pop     ds                 ; Restore ds
51:
52:         mov     di, offset string ; Address test string
53: @@10:
54:         call    StrWrite           ; Display string
55:         call    KeyWaiting         ; Check for a keypress
56:         jz     @@10               ; Loop until any keypress
57:
```

```

58:      push   ds                ; Save ds, changed below
59:      mov    ax, 251Ch         ; Set interrupt 1C vector
60:      mov    dx, [timerOfs]    ; Get saved offset value
61:      mov    ds, [timerSeg]    ; Get saved segment value
62:      int    21h
63:      pop    ds                ; Restore ds
64: Exit:
65:      mov    ah, 04Ch          ; DOS function: Exit program
66:      mov    al, [exCode]      ; Return exit code value
67:      int    21h              ; Call DOS. Terminate program
68:
69: %NEWPAGE
70: ;-----
71: ; SlowMo      Slow Motion Timer Interrupt Service Routine
72: ;-----
73: ; Input:
74: ;      none
75: ; Output:
76: ;      none (waits for time difference)
77: ; Registers:
78: ;      none
79: ;-----
80:
81: ;----- Variables declared inside the code segment, where they
82: ;      will be easy to find during execution of the ISR
83:
84: inProgress   DB      0        ; In-progress flag (0=no, 1=yes)
85: difference   DW      0        ; Relative pause time
86:
87: PROC      SlowMo
88:
89: ;----- Test the inProgress flag, which indicates if a previous
90: ;      copy of SlowMo is already executing. This must be prevented
91: ;      or the system will lock up.
92:
93:      cmp    [byte cs:inProgress], 0 ; Check in-progress flag
94:      jne    @@99                ; Jump if SlowMo is running
95:      inc    [byte cs:inProgress] ; Else, set flag = 1
96:
97:      sti                                ; Allow interrupts to occur
98:      push   ax                    ; Save modified registers
99:      push   ds
100:     push   dx
101:
102:     mov    al, EOI                ; al = end-of-interrupt value
103:     out    PIC8259, al           ; Issue end of interrupt
104:
105:     mov    ax, BIOSData          ; Address BIOS data area
106:     mov    ds, ax                ; with ds
107:     mov    ax, [word LowTimer]   ; Get low word of timer value
108: @@10:
109:     mov    dx, [word LowTimer]   ; Get new timer value into dx
110:     sub    dx, ax                 ; Subtract new-old timer
111:     cmp    dx, [cs:difference]   ; Compare to difference
112:     jb     @@10                  ; Loop until difference passes
113:

```

Listing 10.1. continued

```
114: ;----- Disable interrupts while we clean up and exit after the pause
115:
116:     cli                               ; Disable interrupts
117:     dec [byte cs:inProgress]         ; Reset in-progress flag
118:     pop dx                            ; Restore saved registers
119:     pop ds
120:     pop ax
121: @@99:
122:     iret                               ; Interrupt return
123: ENDP SlowMo
124:
125:     END Start                        ; End of program / entry point
```

Tapping into the PC Timer Interrupt

All IBM PCs—and even less than 100% compatibles—contain a hardware timer that generates an interrupt signal approximately 18.2 times or “ticks” per second. In the ROM BIOS, interrupt 08h services these interrupt signals, which are connected to the 8259 PIC’s input line 0. (See Table 10.1.) This gives the timer interrupt the highest priority. As long as interrupts are enabled, the timer ISR will be the first to execute if more than one interrupt signal occurs simultaneously.

The ROM BIOS timer ISR performs two basic functions. First, the code increments a 32-bit value, thus counting the total number of timer ticks that have occurred since the system was switched on. (This value is zeroed every 24 hours—not necessarily at midnight.) Second, another counter that controls how long the diskette motor stays on is decremented. When this value becomes 0, the disk drive motor is turned off (if it was on), which leaves the disk drive turning long enough to improve floppy disk read and write speeds. (Every time the diskette starts, it takes a moment for the spindle to come up to speed. If the motor were turned off immediately after each read and write, those pauses would slow disk I/O unacceptably.) As you can see, the timer ISR is the PC’s heartbeat and, like all hearts, arresting its duties for too long can lead to problems; therefore, it’s usually wise never to turn off interrupts with `cli` for more than 1/18.2 (about 0.05) seconds before issuing `sti` to switch interrupts back on.

The timer ISR performs a third function that lets you hook into the PC’s heartbeat. At every timer tick, this routine executes a software interrupt number 01Ch, which normally causes no action to occur. By installing your own 01Ch ISR, your code is executed about 18.2 times per second in addition to the timer’s other duties. SLOWMO.ASM uses this feature to add pauses to a running program.

Timer Tick Tricks

The first step in hooking into the PC timer interrupt is to save the current interrupt 01Ch vector, as Listing 10.1 does at lines 37-42, calling DOS function 035h to obtain the vector address in registers `es:bx`, which are saved in the variables `timerSeg` and `timerOfs`. Next, lines 44-50 call DOS function 025h with the address of the new interrupt vector—equal to the offset in the code segment of the `s1owMo` procedure starting at line 87. This replaces the original vector with the address of the new ISR. You could also switch off interrupts and insert the address directly into the appropriate low-memory slot, but calling the DOS routines written for this purpose is easier. Notice how register `ds` is set to the current code segment with:

```
push    cs           ; Push cs onto stack
pop     ds           ; Pop the cs value into ds
```

This is a useful trick to remember and avoids assigning a segment value to a third register (`ax`, for example) only to then assign that value to the destination. When installing your own ISRs, if you use code similar to lines 37-50 to replace existing vectors with the addresses of your own routines, be sure to save and restore segment registers `es` and `ds` as illustrated here.

NOTE

Always restore any interrupt vectors you change in your program. When your program ends, your ISRs are subject to being overlaid by subsequent commands and programs. Therefore, leaving an ISR running after a program ends without also taking steps to protect the memory the ISR occupies is almost certain to cause a system crash. DOS does not restore vectors that your program changes.

Lines 52-56 display a test string and wait for you to press any key, ending the program. During this loop, the `s1owMo` ISR executes, seemingly on its own, but actually as a result of the ROM BIOS timer routine's call to interrupt 01Ch at the rate of 18.2 times per second. Although this may appear to make the loop at lines 52-56 and the ISR run concurrently, remember that interrupts cause the program to pause while the ISR runs—thus, the concurrency is only an illusion conjured by the magic of the PC's timer interrupt.

After you press a key, the program ends. Just before this, lines 58-63 call DOS function 025h once again, but this time with the vector saved earlier. This replaces the original interrupt 01Ch ISR (probably, but not necessarily, addressing a lone `iret` instruction) that was in effect before `SLOWMO` began.

Interrupts and Variables

Listing 10.1's `s1owMo` ISR procedure (lines 70-123) executes when the ROM BIOS timer interrupt executes software interrupt 01Ch. Because this can happen at any time—in between an instruction in the main program, during a call to DOS, or even during a call to

another ROM BIOS routine—the values of segment registers `es` and `ds` cannot be trusted to locate the program's data segment. Because of this, an ISR must be careful to initialize `ds` (and `es` if necessary) before loading or changing data segment variables. One way to do this is to save `ds` and then assign it the value of the data segment, as is usually done at the start of the program:

```

push    ds                ; Save current ds
mov     ax, @data         ; assign data segment address
mov     ds, ax            ; to ds by way of ax
;
;----- Interrupt code goes here
;
pop     ds                ; Restore ds
iret                    ; Return from interrupt

```

The ISR must do this at the start of its code every time it runs, saving the current `ds` value, which the interrupted code may be using to address its own variables. Another method, demonstrated at lines 84-85, is to declare ISR variables inside the code segment. This method requires using a `cs:` segment override to tell the assembler (and the CPU) to use `cs` as the base address for locating variables in memory. For example, to load the `inProgress` byte into `al`, you could execute:

```

mov     al, [byte cs:inProgress]

```

If you did not use the `cs:` override, the assembler would assume that `ds` addresses the current data segment, a common mistake that often leads to disaster. Because there's no way to predict the value of `ds` or any other register during an externally executed ISR, addressing variables without either reinitializing `ds` or without using a segment override to access data in the code segment could overwrite memory locations belonging to other programs.

Interrupting ISRs

As explained earlier, the timer interrupt is the PC's heartbeat. Because it's vital that the timer not be disabled for very long, interrupts must be turned on in the `s1owM0` ISR (line 97). This poses a tricky problem. If interrupts are on, it's very likely that the ISR could actually interrupt itself. In this case, the ISR code would pause, the `flags`, `cs` and `ip` registers would be pushed onto the stack, and the timer interrupt would be serviced. If this happened repeatedly with no opportunity for the ISR invocations to unwind, the stack would eventually overflow, probably leading to a system crash.

When a routine is allowed to interrupt itself, it is said to be *reentrant*—in other words, a new instance of the code sequence can begin running from the top before a previous instance finishes. Such code must allocate fresh space for variables—global variables won't do. To understand why, consider the `s1owM0` ISR. Because there is only one each of the `inProgress` and `difference` variables at lines 84-85, the new invocation of the code will use these same

variables, possibly changing their values, if the ISR is allowed to interrupt itself. Therefore, when this second execution of `S1owMo` ends, causing the original instance to pick up again, the variables may have changed—a side effect that must be prevented if the routine is to be truly reentrant.

NOTE

You may have heard that DOS and the ROM BIOS are not reentrant. This means that the routines access global variables, similar to those in `S1owMo`. Such routines can't reenter themselves because there is only one set of variables. In reality, however, some DOS and BIOS routines are reentrant, despite their use of global variables. The timer interrupt is a prime example—it certainly may and does interrupt itself without conflict. In fact, to keep the system time correct, it must do so.

Obviously, because it uses only one set of global variables, our `S1owMo` routine is definitely not reentrant. But, to keep the system clock running during `S1owMo`'s lengthy pause, interrupts *must* be enabled—even though this will cause subsequent timer interrupts to reexecute `S1owMo`, in effect “pausing the pause” and stopping the system dead in its tracks. We have a difficult problem to solve: The vital PC timer interrupts must be allowed to execute during a lengthy pause, while our own `S1owMo` ISR must be prevented from interrupting itself, which it will do anyway as a result of the timer ISR executing another `01Ch` interrupt. Whew!

Luckily, there's a simple answer to this typical conflict, demonstrated here at lines 93-95. First, the `inProgress` byte is examined. If this byte is 0, the ISR is allowed to run normally. If the `inProgress` byte is not 0, the program assumes that a previous instance of the ISR has been interrupted. This must be so because only line 95 sets `inProgress` to 1 (via an `inc` instruction) and only line 117 resets `inProgress` to 0. If `inProgress` is not 0 at the start of `S1owMo`, then the instructions between lines 98-116 must have been interrupted by a timer tick, causing `S1owMo` to be reentered. The simple `inProgress` flag detects this condition, allowing only one instance of the ISR to execute. As a result, the ROM BIOS timer ISR may continue to run during an execution of `S1owMo`, keeping the system clock on time.

NOTE

The Print Screen function uses a similar trick to prevent you from pressing the `PrtSc` key more than once while a screen dump is in the process of printing. When you press the `PrtSc` key and printing begins, a second `PrtSc` key press actually restarts the Print Screen function. But a flag similar to `inProgress` indicates that a previous printing operation is executing, thus preventing multiple screen printouts when only one is wanted.

The End-of-Interrupt Command

Line 97 is `SLOWMO.ASM` turns on interrupts with `sti`, allowing the PC timer to continue running during `slowMo`'s pause. Because timer interrupts come in via the 8259 PIC as described earlier, `sti` alone is not sufficient to allow future interrupts to be recognized. In addition to `sti`, you must also tell the 8259 PIC that you want fresh interrupts to be processed. Do this by issuing an *end-of-interrupt* (EOI) command to the 8259 port:

```
EOI      EQU      020h      ; End-of-interrupt value
PIC8259  EQU      020h      ; 8259 port address

sti                      ; Allow interrupts to occur
mov      al, EOI         ; al = end-of-interrupt value
out      PIC8259, al     ; Issue end of interrupt
```

Both `EOI` (the end-of-interrupt equate) and `PIC8259` (the port address equate) have the same value `020h`, a meaningless coincidence. The `sti` instruction sets the `if` flag in the processor, which was reset automatically by the processor upon recognizing the interrupt signal that caused the ISR to begin running. Setting `if` allows the processor to again recognize external interrupt signals. Because those signals come from the 8259, the end-of-interrupt command also must tell the 8259 to pass the interrupts it receives along to the processor. Executing `sti` alone is not enough. When servicing interrupts generated via the 8259—and any interrupts called from inside the associated ISRs, as in the case of `slowMo`—you must issue this same three-instruction sequence to allow future external interrupts to occur.

You are probably getting the idea by now that servicing interrupts—particularly those attached to the PC timer—requires you to be on your toes. Most of the work in writing ISRs is overhead—avoiding conflicts with global variables, dealing with reentrancy issues, making sure future interrupts can occur, saving and restoring register values, and so on. The actual guts of an ISR may be relatively simple, as they are in this example at lines 105-112. These instructions examine the low word of the timer tick value, which the ROM BIOS timer ISR increments as described earlier. When this value increases by the amount of the difference variable, the `slowMo` ISR exits.

Notice that no instruction in the closed loop at lines 108-112 changes the `LowTimer` value directly. If you were to read this code out of context, the loop would seem to be incomplete, and you might assume that you had found a bug. If no instruction changes `LowTimer`, then the subtraction at line 110 will always be 0, causing the `jb` at line 112 to repeat endlessly. The fact that this does not happen proves that the ROM BIOS timer ISR is executing independently of the loop, incrementing the timer counter 18.2 times a second and eventually causing the `jb` to allow the program to continue.

Interrupts and Stacks

Because external interrupts can occur at any time, there's no way to predict the values of segment registers when an external ISR begins running. The only segment register you can depend upon is `cs`. Obviously, this register always equals the value of the current code segment containing the instructions that are now executing. But `es`, `ds`, and `ss` might point anywhere. As explained earlier, to reference local data, you must initialize `ds` and `es`, preserving their current values for restoring just before the ISR ends. Unfortunately, correct handling of the stack-segment register is not so simple.

In Listing 10.1's ISR procedure `S1owMo`, three words are pushed onto the stack at lines 98-100. But which stack? DOS has its own stack space, as does the main program. In addition, there may be other ISRs in memory that have their own stacks. If any of these programs is interrupted, the value of `ss` will be the value assigned by that program. In other words, ISRs normally use whatever stack segment is current when the interrupt occurs. `S1owMo` simply assumes that at least three words of stack space are available—in addition to the three words required by the processor, which pushes onto the stack the flags and `cs:ip` registers before executing the ISR.

In most cases, it's probably safe to assume that a little stack space will always be available. But to many programmers, such an assumption is a painfully vague pill to swallow in the meticulous world of computer programming that demands exacting perfection from its practitioners. If relying on faith seems chancy—and especially if your ISR requires more than a few bytes of stack memory—you must switch to a local stack.

NOTE

In your own programs, always add a few more bytes to your `STACK` directive than strictly required. Otherwise, you may cause problems for ISRs, ROM BIOS routines, DOS, and other resident code that assumes a few stack bytes will be available. Some DOS references recommend a minimum stack size of 2,048 bytes, although simple examples such as the programs in this book can usually get away with far less.

Changing stacks in an ISR is not difficult, but you must execute the instructions in the correct order. The reason for this is that the 8086 temporarily disables interrupts for exactly one instruction whenever you assign a value to a segment register. In other words, when you write the familiar initialization code,

```
mov     ax, @data
mov     ds, ax
mov     dx, offset string
```

interrupts are off for the `mov` to `dx`—a fact that’s not evident from the source text. In this example, the effect on interrupts is unimportant. But consider what happens when changing the stack-segment register:

```
mov    ax, offset stackSpace
mov    ss, ax
mov    sp, offset endOfStack
```

Register `sp` is the stack pointer, locating the current top of the stack relative to the segment address in `ss`. Because two instructions are required to change both `ss` and `sp`, if an interrupt occurred between the assignment to `ss` and the assignment to `sp`, the old stack pointer would be used along with the new stack segment—a dangerous situation that can easily lead to a system crash. For this reason, interrupts are disabled for one instruction after the assignment to `ss`—just enough time to assign the `endOfStack` value to `sp`. Interrupts are also disabled for `pop` instructions involving a segment register. Remember, this effect lasts for only one instruction, and the `mov` to `sp` *must* immediately follow the `mov` to `ss`.

NOTE

When assigning a value to `ss`, always follow immediately with an assignment to `sp`. Never reverse these two instructions and never insert an instruction between the two assignments. These steps are not optional!

In an ISR routine, to switch to a local stack, first declare some space in your program’s code segment. There are many possible approaches, but this works:

```
ALIGN
myStack      DB      512 DUP (0)    ; Local 512-byte stack
endOfStack   =      $
```

The `ALIGN` directive ensures that the stack begins on a word boundary, in other words, at an even address. The stack begins at `myStack` and, in this sample, is 512 bytes long. A numeric equate `endOfStack` marks the bottom of the stack space. Next, save the current values of `ss` and `sp` in global variables, which you’ll use later to restore the registers to their values at the start of the routine:

```
oldSS        DW      0              ; Hold stack segment
oldSP        DW      0              ; Hold stack offset

PROC  ISR
      mov    [cs:oldSS], ss        ; Save stack segment
      mov    [cs:oldSP], sp        ; Save stack pointer
```

Because the variables are declared in the code segment, a segment override `cs:` is needed to save `ss` and `sp` at the correct locations. After this, you're ready to switch the local stack, assigning the current code-segment value to `ss` and the `endOfStack` offset to `sp`. Note that this still requires one word of stack space for pushing `cs`:

```
push cs           ; Push current code segment
pop  ss          ; Pop cs value into ss
mov  sp, offset endOfStack ; Interrupts disabled temporarily
```

To eliminate even this much stack usage requires using a third variable to save `ax` (or another register). Because you can't assign the value of one segment register to another, the current `cs` value is first assigned to `ax`, which is then assigned to `ss`:

```
oldAX  DW      0           ; Variable in code segment
mov    [cs:oldAX], ax      ; Save ax in variable
mov    [cs:oldSS], ss      ; Save stack segment
mov    [cs:oldSP], sp      ; Save stack pointer
mov    ax, cs             ; Assign cs to ax
mov    ss, ax             ; Assign ax to ss (ss = cs)
mov    sp, offset endOfStack ; Interrupts disabled temporarily
```

Later, you can restore `ax` from the saved value at `cs:oldAX`. Usually, you don't have to go to such lengths—at least three words of stack space must have been available to execute the ISR in the first place, and it's reasonable to assume that at least one more word will be available.

Because the stack grows from high-memory addresses toward low-memory addresses, `sp` must be initialized to point to the end of the stack, not to the beginning. Also, because a `push` instruction decrements the stack pointer by 2 before transferring the pushed word to the location addressed by `ss:sp`, it's safe for `sp` to address the memory location just *after* the last byte allocated to the stack. But some programmers prefer to use an alternate instruction to load `sp`:

```
mov    sp, offset endOfStack-2
```

which points `ss:sp` to the last word in the stack, rather than to the byte beyond the bottom of the stack. This wastes one word of stack space but ensures that `sp` never points to anywhere but a legal stack location.

After switching to the local stack, you can push registers, refer to variables relative to `bp`, and so on. Remember, your new stack might be shared by any other interrupts that occur during this ISR's execution. After the ISR is done, restore the original stack with the instructions:

```
mov    ss, [cs:oldSS]      ; Restore stack segment register
mov    sp, [cs:oldSP]      ; Restore stack pointer register
```

Again, be sure to execute these instructions in this order without any other intervening instructions as interrupts will be temporarily disabled during the assignment to `sp`.

NOTE

Saving and restoring `ss` and `sp` from global variables brings up the old question of reentrancy again. In the previous examples, because the new stack space is a global variable, the ISR must be prevented from interrupting itself. Attempting to write a completely reentrant ISR that switches to a local stack will certainly put hair on your chest. You'll need fresh stack space and variables for each ISR invocation or, at the very least, an `inProgress` flag as in `S10wMo` to prevent a reentered ISR from corrupting a stack used by a previous call to the same routine.

Using `int` and `into` Instructions

As you know, DOS functions are called by the software interrupt instruction `int 21h`. True interrupts are generated externally and can occur at any time. Software interrupts called by `int` can occur only when a program executes this instruction. Therefore, software interrupts operate more like common subroutines than ISRs. Except for this difference, internal software and external hardware interrupts are identical, vectoring through values in low memory to the start of the ISR with the flags and `cs:ip` registers pushed on the stack. Software interrupts end with the same `iret` instruction, too.

One interesting fact is that `int` calls are not disabled by clearing `if` with `cli`. You can always call software interrupts even when external interrupts are disabled. You can even call an external ISR with an `int` instruction. For example, it's perfectly legal to "generate" your own timer tick with:

```
int    08h        ; Force a timer tick
```

There may not be any good reason for forcing the ROM BIOS timer ISR to run as the result of a software interrupt instruction, but there's nothing to prevent you from doing this—even though doing so frequently is likely to throw the system clock out of kilter. Also, be aware that some ISRs (the BIOS code for keyboard interrupt `09h`, for example) assume that certain registers in various circuits have data to process. This might not be true if you force a hardware interrupt to occur via a software `int` instruction. But calling hardware interrupts with software `int` instruction is a useful technique for debugging external ISRs, letting you simulate the effects of hardware that, perhaps, doesn't yet exist.

In addition to `int`, you can also use the instruction `into` (interrupt on overflow) to force an interrupt type 4 if the overflow flag is set (`of = 1`) as the result of a previous arithmetic instruction. In practice, the `into` instruction is rarely used, and the interrupt vector for interrupt number 4 normally points to a plain `iret` instruction, thus having no effect even if a program does execute `into`. You can assign this vector (using DOS function `025h` as described earlier) to your own ISR if you want to handle overflows with an ISR of your own design.

Trapping Divide-Fault Interrupts

The misnamed “divide-by-zero” interrupt is the source of much misinformation. A `div` or `idiv` instruction causes an automatic interrupt type 0 whenever the result of a division is larger than the maximum value that can be held in the destination (ax or al) and also when the divisor is 0. For example, this code causes an interrupt type 0:

```

mov    ax, 100h    ; Assign 100h to ax (Low word)
xor    dx, dx      ; Zero dx (high word)
xor    bx, bx      ; Zero bx (divisor)
div    bx          ; Divide ax:dx by bx

```

Because the divisor (bx) is 0, the `div` fails, executing the ISR at the vector stored at 0000:0000—the first location in memory. What many people fail to realize is that the following code also generates a divide-by-zero interrupt:

```

mov    ax, 100h    ; Assign 100h to ax
mov    bl, 1       ; Set divisor (bl) to 1
div    bl          ; Interrupt type 0 generated

```

The result of dividing 100h by 1 is, of course, 100h. But because this value is too large to fit within an 8-bit divide’s destination register al, an interrupt type 0 is generated, even though the divisor is definitely not 0. For this reason, the divide-by-zero interrupt is better named the “divide-fault” interrupt, which you can’t circumvent with code such as:

```

        or     bl, bl      ; Is divisor 0?
        jne   @@10        ; Jump if yes (bl = 0)
        call  Error       ; Call error handler
@@10:
        div   bl          ; ??

```

Despite appearances, this does not prevent an interrupt type 0 from occurring. Checking whether the divisor is 0 before executing `div` is a waste of time because an interrupt type 0 occurs whenever the result of a division exceeds the capacity of the destination register. When this happens, an ISR inside DOS executes, halting the program—an event that commercial programs must prevent. The solution is to install a custom divide-fault ISR to replace the DOS ISR for interrupt 0. As you will see, however, this is more difficult to do than you may suspect.

Fixing a Divide Fault

What should happen when a divide fault occurs? The answer depends on the application. A calculator program should probably display an error symbol. A spreadsheet program might insert an error message into a “cell” on screen. Another less critical program might simply ignore the condition—useful in some cases, as long as the program executing the division is aware of this possibility. A common approach is to write a simple ISR such as:

```

PROC    DivFault
xor     ax, ax      ; Optionally set quotient to 0
iret                    ; Return from interrupt
ENDP    DivFault

```

Reassigning the interrupt 0 vector to `DivFault` causes an `iret` instruction to execute if a divide fault occurs, which would seem to be the easy way to ignore such an error. The quotient is optionally reset to 0—a reasonable (if not correct) answer in the event of a divide error. Unfortunately, this solution works only on systems with 8086/88 processors. On systems with 80286 and later-model processors, the `iret` in this example actually returns to the same `div` or `idiv` that caused the interrupt to occur—effectively locking the system. The reason this happens is that an interrupt level 0 pushes the address of the *next* instruction for 8086/88 processors, but it pushes the address of the *current* instruction for 80286 and later processors. This is an extremely nasty problem for programmers who have to write code to run on a wide range of PCs, XTs and ATs.

Correctly handling this unusual condition requires some fancy footwork. The answer is to adjust the offset return address on the stack to skip the `div` or `idiv` instruction that caused the ISR to begin running. Some references recommend just adding 2 to the offset portion of the return address on the stack and then ending the ISR with `iret`. But this common plan fails to take into account that a `div` or `idiv` instruction can be 2 or 4 bytes long, depending on whether the divisor is a register (2 bytes) or a memory location (4 bytes). Dealing with this situation requires peeking back at the machine code of the `div` or `idiv` instruction. If the first two bits of the second byte equal 1, then the operand is a register; otherwise, the operand is a memory reference. Knowing this, the program can adjust the return address by 2 or 4, skipping the `div` or `idiv` on executing `iret`.

NOTE

Deciphering the bits that make up individual machine codes is painstaking work and, fortunately, is rarely necessary. See Bibliography for references that document that exact bit formats for other machine-code instructions.

Installing a Divide-Fault Handler

A good way to handle divide faults is to install a memory-resident program to trap type 0 interrupts if they occur. After doing this, all divide errors are routed through the new ISR, preventing DOS from halting a program unexpectedly. Listing 10.2, `DIV286.ASM`, accomplishes this while also demonstrating how to write memory-resident assembly language programs.

NOTE

Despite its name, `DIV286.ASM` is not restricted to running on computers with 80286 processors. You may run this program on any PC with an 80286, 80386, 80486, Pentium, or compatible processor.

Assemble DIV286 and link with the commands:

```
tasm div286
tlink /t div286,,, mta
```

Don't run DIV286 just yet—you'll first want to execute a second program (described in a moment) to test the effects of the new interrupt handler. Notice the /t switch in the tlink command; it is necessary to create a .COM file instead of the usual .EXE format. Memory resident .EXE code files are more difficult to write, although they can be larger than resident .COM files, which are limited to about 64K. For our purposes, the .COM format is more than adequate.

NOTE

You must have an 80286 or later-model processor to use DIV286.ASM. To create a similar program for 8086 and 8088 systems, replace lines 42-61 with the much simpler DivFault procedure listed earlier. You might want to name this program DIV86.ASM. A copy of the finished program is included on the disk.

Listing 10.2. DIV286.ASM.

```
1: %TITLE "80286 and later-model Divide-Fault ISR -- by Tom Swan"
2:
3:     IDEAL
4:
5:     MODEL    tiny
6:
7: cr    EQU    13
8: lf    EQU    10
9:
10:
11:     DATASEG
12:
13: welcome DB    cr, lf, '80286/386 Divide-Fault Handler Installed'
14:         DB    cr, lf, 'Address = ', 0
15: string  DB    40 dup (?)
16:
17:
18:     CODESEG
19:
20:     ORG    100h           ; Standard .COM start address (origin)
21:
22:     EXTRN  StrWrite:proc, BinToAscHex:proc, NewLine:proc
23:
24: Start:
25:     jmp    Begin         ; Jump over resident ISR
26:
```

continues

Listing 10.2. continued

```

27: %NEWPAGE
28: ;-----
29: ; DivFault          Divide-Fault handler ISR
30: ;-----
31: ; Input:
32: ;     none (called internally upon a DIV or IDIV fault)
33: ; Output:
34: ;     ax = 0 (al=8-bit quotient, ax=16-bit quotient)
35: ;
36: ;     Note: Program continues normally with the instruction
37: ;     following the DIV or IDIV that caused the fault.
38: ;
39: ; Registers:
40: ;     ax changed
41: ;-----
42: PROC    DivFault
43:     sti                ; Enable CPU interrupts
44:     push    bp         ; Save current bp register
45:     mov     bp, sp     ; Address stack values with ss:bp
46:     push    si         ; Save other modified registers
47:     push    ds
48:     lds    si, [bp + 2] ; Address DIV or IDIV with ds:si
49:     lodsw                ; Get DIV plus second byte (in ah)
50:     and    ah, 0C0h    ; Isolate first two bits (MOD field)
51:     cmp    ah, 0C0h    ; Are bits = 1? (register based instr)
52:     je     @@10        ; Jump if yes--DIV is 2 bytes long
53:     add    [word bp + 2], 2 ; DIV is 4-bytes add 2 to offset
54: @@10: add    [word bp + 2], 2 ; Add 2 (or 2 more) to offset
55:     xor    ax, ax      ; Set quotient to 0 (remainder also 0
56:                                ; for 8-bit divide only)
57:     pop    ds         ; Restore saved registers
58:     pop    si
59:     pop    bp
60:     iret                ; Return from interrupt
61: ENDP    DivFault
62:
63: Begin:
64:     mov    ax, 2500h    ; Set new vector for Divide
65:     mov    dx, offset DivFault
66:     int    21h
67:     mov    di, offset welcome ; Display welcoming message
68:     call   StrWrite
69:     mov    ax, cs      ; Display segment value
70:     call   ShowAX
71:     mov    dl, ':'     ; Display a colon (:)
72:     mov    ah, 2
73:     int    21h
74:     mov    ax, offset DivFault ; Display offset value
75:     call   ShowAX
76:     call   NewLine
77:

```

```

78: ;----- Terminate and stay resident, keeping only the code up to
79: ;         the end of the new Divide-Fault ISR
80:
81: Exit:
82:     mov     dx, offset Begin           ; New free mem address
83:     int     27h                       ; Terminate, stay resident
84:
85: ;----- Subroutine to display AX in hexadecimal
86:
87: PROC     ShowAX                       ; Show value in AX
88:     mov     cx, 4                      ; Minimum number of chars
89:     mov     di, offset string         ; Address of string variable
90:     call    BinToAscHex               ; Convert AX to hex
91:     call    StrWrite                  ; Display hex string
92:     ret                                     ; Return to caller
93: ENDP    ShowAX
94:
95:     END     Start                     ; End of program / entry point

```

Testing DIV286

To test the before and after effects of DIV286, assemble Listing 10.3, DIVFAULT.ASM, which forces a divide fault to occur. Assemble and link to MTA.LIB in the usual way:

```
tasm divfault
tlink divfault,, mta
```

Run the test program by typing `divfault` and pressing Enter. This should generate the DOS message "Divide Overflow," halting the program prematurely. Depending on your version of DOS (and, perhaps, other resident programs loaded into memory), you may have to reboot by pressing Ctrl-Alt-Delete. Some DOS versions are known to become unstable following a divide-fault error.

Next, execute DIV286 to install the resident ISR. (On 8086 and 8088 systems, run the modified DIV86 program instead. Do not run DIV86 if your system has an 80286 or later processor.) Then run DIVFAULT again. This time, you should see the message "Program continued normally," proving that DOS no longer halts the program upon receiving a divide-fault interrupt.

NOTE

Run DIV286 or DIV86 only one time or you'll needlessly install multiple copies of the divide-fault handler in memory.

Listing 10.3. DIVFAULT.ASM.

```

1: %TITLE "Divide Fault Demonstration -- by Tom Swan"
2:
3:     IDEAL
4:
5:     MODEL    small
6:     STACK   256
7:
8: cr    EQU    13           ; ASCII carriage return
9: lf    EQU    10          ; ASCII line feed
10:
11:
12:     DATASEG
13:
14: exCode    DB    0
15: message1  DB    cr,lf,'Forcing a divide by zero fault...',0
16: message2  DB    cr,lf,'Program continued normally',cr,lf,0
17:
18:
19:     CODESEG
20:
21: ;----- From STRIO.OBJ
22: EXTRN    StrWrite:proc
23:
24: Start:
25:     mov    ax, @data           ; Initialize DS to address
26:     mov    ds, ax             ; of data segment
27:     mov    es, ax             ; Make es = ds
28:
29:     mov    di, offset message1 ; Address welcome message
30:     call   StrWrite
31:
32:     mov    ax, 100h           ; Assign value to ax
33:     xor    bx, bx             ; Zero divisor
34:     div    bx                 ; Force Divide-Fault Exception
35:
36: Exit:
37:     mov    di, offset message2 ; Address "continued" message
38:     call   StrWrite           ; Display string
39:
40:     mov    ah,04Ch            ; DOS function: Exit program
41:     mov    al,[exCode]        ; Return exit code value
42:     int    21h                ; Call DOS. Terminate program
43:
44:     END    Start              ; End of program / entry point

```

How DIV286 Works

DIV286 calls the DOS Terminate-and-Stay-Resident (TSR) software interrupt 27h at line 83, installing in memory a copy of the divide fault ISR at lines (28-61). Executing `int 27h` returns control to `COMMAND.COM` but tells DOS to retain all occupied memory up to the address in `cs:dx`. Line 82 sets `dx` to the offset address just below the last instruction to be

kept in memory—in this example, the `iret` at line 60. There are other ways to install TSR code—for example, DOS function 031h—but when the size of the program is relatively small (less than about 64K), interrupt 27h is much easier to use.

Notice that a `DATASEG` directive is used to declare program variables at lines 11-15. Because this is a `.COM` program, the data and code segments are actually one and the same. The stack segment in a `.COM` program also shares the same 64K segment; consequently, the program does not specify a separate stack in a `STACK` directive.

NOTE

By the way, variables declared after a `DATASEG` directive in a `.COM` program are stored above (at a higher address than) the executable code. As a result, these variables do not remain in memory after executing interrupt 27h. Variables that must remain resident after the program ends should be declared in the code segment at an offset below (at a lower address than) the address passed to interrupt 27h in `cs:dx`.

Installing TSR Code in Memory

The first instruction in a TSR program usually jumps over the code that is to remain in memory after the program ends (see line 25). The actual first instruction in the program is at the destination of this jump—in `DIV286`, at label `Begin:` (line 63). Here, the divide-fault interrupt vector is changed to the address of the new ISR—the resident portion of this program at lines 28-61.

Be sure you understand that `DIV286` is really two programs in one convenient package. The code that runs when you execute `DIV286` starts at line 25, jumps to line 63, and ends at line 93. The resident `DivFault` procedure does not execute at this time. Instead, this ISR remains in memory after `DIV286` ends, ready to handle a divide error when it occurs. The sole purpose of the `DIV286` program is to install the `DivFault` ISR and to display a memory on-screen that this has been done. To help you locate the code in memory (if you need to do this), `DIV286` also displays the address where `DivFault` resides.

After `DIV286` ends, leaving the `DivFault` ISR behind, a subsequent divide-fault interrupt executes the ISR, starting at line 43, which immediately executes `sti`, allowing other interrupts to be serviced while `DivFault` runs. At this point, the stack contains the system flags plus the address of the `div` or `idiv` instruction that caused the interrupt to occur. Borrowing a popular technique from high-level languages, `DivFault` locates the return address on the stack, first executing the instructions:

```
push    bp           ; Save current bp
mov     bp, sp      ; Address stack with bp
```

The order of these two instructions is important. First, the current value of register `bp` is saved on whatever stack space happens to be in use. Then the value of the stack pointer `sp` is assigned to `bp`, thus addressing the stack with `ss:bp`. (Addressing memory with the `bp` register defaults to the segment addressed by `ss`. You could use other registers to address data on the stack, but `bp` is the most convenient.)

Figure 10.1 illustrates how the stack appears during execution of the `DivFault` ISR. (The return address, flags, and other values on a stack make up what's known as a procedure's *stack frame*.) When addressing variables on the stack, it helps to draw a diagram of the stack frame. Disturbing the wrong data on the stack can have disastrous results, so there's precious little room for error. Figure 10.1 labels the stack pointer at different stages, while `DivFault` executes:

- `sp0`: The stack pointer before the divide-fault interrupt occurs.
- `sp1`: The stack pointer after the divide-fault interrupt signal is processed. The processor has pushed the flag, `cs`, and `ip` registers onto the stack.
- `sp2`: The stack pointer after pushing the current value of `bp`
- `sp3`: The stack pointer after pushing registers `si` and `ds`

The plan is to read the values of `cs:ip` from the stack, examine the `div` or `idiv` instruction, and increment the return address by either 2 or 4 bytes. To do this, register `bp` was assigned the value of `sp2`, thus addressing stack byte number 4. (The numbers in the diagram are there just for reference—they don't refer to real memory addresses.) Because each box in the figure represents a 2-byte word, the 16-bit `ip` register value is at `[bp + 2]`. The `cs` register value is at `[bp + 4]`. If you wanted to access the flags on the stack, you could use `[bp + 6]`.

Figure 10.1.
The stack frame during execution of the `DivFault` ISR in `DIV286.ASM`.

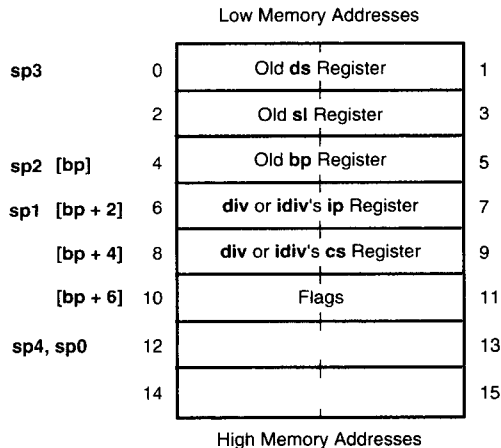

Line 48 of `DIV286.ASM` executes `lds` to load the `ds` and `si` registers with the address of the `div` or `idiv` instruction that caused the divide-fault interrupt. You could just as well use two `mov` instructions to load the words at `[bp + 2]` and `[bp + 4]`, but `lds` performs the same job and is shorter and a little faster. (You can use any 16-bit register as the destination for the offset portion of the address, not only `si`.)

After line 48, `ds:si` addresses the faulty `div` or `idiv`. Line 49 loads the first word of this instruction into `ax` for examination. If the first 2 bits are equal to 1, then this is a 2-byte instruction; otherwise, it's a 4-byte version. Lines 53-54 increment the offset portion of the return address on the stack accordingly by 2 or 4 bytes.

The net effect of these actions is to ignore the `div` or `idiv` that caused the interrupt type 0. Register `ax` is cleared (line 55), setting the 8-bit (`al`) or 16-bit (`ax`) quotient to 0. (Note: For 8-bit divides, this also sets the remainder in `ah` to 0.) Because the return address was incremented, when the interrupt ends at line 60, program execution continues with the instruction following the faulty divide.

Interrupt-Driven Serial Communications

DOS has its critics but even fans agree with detractors about one thing: Asynchronous serial I/O (also called auxiliary I/O) in DOS is about as useful as shoes for a mermaid. Although there are two DOS functions available for reading (function 3) and writing (function 4) characters to a serial I/O port, experts generally agree that programs using these functions are unreliable except, perhaps, at the slowest baud rates. There are at least three possible solutions to the problem:

1. Write a custom device driver for reading and writing to a serial ports as a named file.
2. Call the BIOS asynchronous interrupt 14h directly for all serial communications.
3. Install interrupt-driven code to read and write characters independently of DOS and the BIOS.

Number 1 is a good idea, especially if you need to access special communications hardware—a multiport peripheral card, for example. However, writing custom device drivers is a subject that would require an entire chapter and, therefore, is an impractical solution to cover here. (Most good DOS programming references discuss this subject in detail.) Number 2 is also good. The ROM BIOS in all PCs handles asynchronous serial I/O with excellent results. But, even though number 3 requires direct access to hardware registers—thus making the program difficult to transfer to non-PCs—an interrupt-driven asynchronous serial I/O package makes writing communications programs so much easier than the other two methods that most programmers prefer this approach.

Listing 10.4, ASYNCH.ASM, can serve as the basis for any communications program. The code implements a buffered, interrupt-driven, input channel for incoming data and uses a non-interrupt-driven method for output. After the listing is an example program that demonstrates how to use the ASYNCH module. Assemble, link, and install ASYNCH in MTA.LIB with the commands:

```
tasm /zi asynch
tlib /E mta -+asynch
```

As usual, ignore any warning about ASYNCH not being in the library. If you change any of ASYNCH.ASM, repeat these two steps. Take out the /zi option to reduce code-file size by stripping the information for Turbo Debugger.

NOTE

Change the equate value at line 9 to 0 for COM1: or to 1 for COM2:.

Listing 10.4. ASYNCH.ASM.

```
1: %TITLE "Asynch Serial Comm Module -- by Tom Swan"
2:
3:     IDEAL
4:
5:     MODEL    small
6:
7:     PUBLIC  ComPort
8:
9:     ComPort = 0           ; 0 = COM1:, 1 = COM2:
10:
11: IF ComPort EQ 0
12:     Port      EQU    03F8h ; 8250 base address
13:     VectorNum EQU    0Ch  ; Interrupt vector number
14:     EnableIRQ EQU    0EFh ; Mask to enable 8259 IRQ
15:     DisableIRQ EQU    10h  ; Mask to disable 8259 IRQ
16:
17: ELSEIF ComPort EQ 1
18:     Port      EQU    02F8h ; same comments as above
19:     VectorNum EQU    0Bh
20:     EnableIRQ EQU    0F7h
21:     DisableIRQ EQU    08h
22: ELSE
23:     DISPLAY "ComPort must be 0 or 1"
24:     ERR
25: ENDIF
26:
27: ;----- Adapter register addresses
28:
```

INTERRUPT HANDLING

```

29: TxRegister      =      Port + 0      ; Transmit Register
30: RxRegister      =      Port + 0      ; Receive Register
31: IntEnable       =      Port + 1      ; Interrupt Enable Register
32: IntIdent        =      Port + 2      ; Interrupt Identification
33: LineControl     =      Port + 3      ; Line Control Register
34: ModemControl    =      Port + 4      ; Modem Control Register
35: LineStatus      =      Port + 5      ; Line Status Register
36: ModemStatus     =      Port + 6      ; Modem Status Register
37:
38: ;----- Other equates
39:
40: Ctrl18259_0     EQU      020h        ; 8259 port
41: Ctrl18259_1     EQU      021h        ; 8259 port (masks)
42: EOI              EQU      020h        ; 8259 end-of-interrupt
43: BufSize         EQU      2048        ; Size of input buffer
44:
45:
46:          DATASEG
47:
48: vectorSeg       DW      ?            ; Old vector segment
49: vectorOfs       DW      ?            ; Old vector offset
50: bufHead         DW      ?            ; Buffer head pointer
51: bufTail         DW      ?            ; Buffer tail pointer
52: buffer          DB      BufSize DUP (?) ; Input buffer
53:
54:
55:          CODESEG
56:
57:          PUBLIC  AsynchInit, AsynchStop, AsynchStat
58:          PUBLIC  AsynchOut, AsynchIn, AsynchInStat
59:
60: %NEWPAGE
61: ;-----
62: ; EmptyBuffer          Empty the input buffer
63: ;-----
64: ; Note:
65: ;     Private to module
66: ; Input:
67: ;     none
68: ; Output:
69: ;     none
70: ; Registers:
71: ;     none
72: ;-----
73: PROC      EmptyBuffer
74:          cli                      ; Prevent interrupts
75:          push  ax                  ; Save ax
76:          mov   ax, offset buffer   ; Buffer is empty when
77:          mov   [bufHead], ax      ; the head and tail pointers
78:          mov   [bufTail], ax     ; are equal
79:          pop   ax                  ; Restore ax
80:          sti                      ; Enable interrupts
81:          ret                       ; Return to caller
82: ENDP      EmptyBuffer

```

continues

Listing 10.4. continued

```

83: %NEWPAGE
84: ;-----
85: ; AsynchInit          Initialize serial port and install ISR
86: ;-----
87: ; Input:
88: ;     none
89: ; Output:
90: ;     none
91: ;
92: ;     NOTE: Precede (usually) with call to int 14h to
93: ;     set baud rate
94: ;
95: ;     NOTE: Interrupt-driven input begins immediately
96: ;     upon exit from this routine.
97: ;
98: ;     WARNING: You must call AsynchStop before your
99: ;     program ends to avoid a system crash!
100: ;
101: ; Registers:
102: ;     ax, bx, dx
103: ;-----
104: PROC    AsynchInit
105:
106:     call    EmptyBuffer          ; Initialize buffer
107:
108: ;----- Save and reassign interrupt vector
109:
110:     push    ds                    ; Save segment registers
111:     push    es
112:     mov     ax, 3500h + VectorNum ; Get vector address
113:     int     21h                   ; Call DOS
114:     mov     [vectorSeg], es       ; Save segment address
115:     mov     [vectorOfs], bx       ; Save offset address
116:     push    cs                    ; Address AsynchISR
117:     pop     ds                    ; with ds:dx, and call
118:     mov     dx, offset AsynchISR ; DOS function 25h to
119:     mov     ax, 2500h + VectorNum ; set the new vector
120:     int     21h                   ; address.
121:     pop     es                    ; Restore saved registers
122:     pop     ds
123:
124: ;----- Enable 8259 interrupt (IRQ) line for this asynch adapter
125:
126:     in     al, Ctr18259_1         ; Read 8259 enable masks
127:     and    al, EnableIRQ          ; Clear masked bit
128:     out    Ctr18259_1, al        ; Write new 8259 masks
129:
130: ;----- Enable 8250 interrupt-on-data-ready
131:
132:     mov    dx, LineControl        ; First, read the line control
133:     in     al, dx                 ; register, and clear bit
134:     and    al, 07Fh               ; 7, the Divisor Latch Access
135:     out    dx, al                 ; Bit, or DLAB
136:     mov    dx, IntEnable          ; With DLAB=0, set bit 0 of
137:     mov    al, 1                  ; interrupt enable register
138:     out    dx, al                 ; to 1, enabling interrupt
139:

```

INTERRUPT HANDLING

```

140: ;----- Clear 8250 status and data registers
141:
142: @e10:
143:     mov     dx, RxRegister           ; Clear data register
144:     in      al, dx                   ; by reading port
145:     mov     dx, LineStatus          ; Clear line status
146:     in      al, dx                   ; by reading port
147:     mov     dx, ModemStatus         ; Clear modem status
148:     in      al, dx                   ; by reading port
149:     mov     dx, IntIdent            ; Check interrupt ident
150:     in      al, dx                   ; register
151:     test    al, 1                    ; Bit 1 should be 1
152:     jz      @e10                     ; Jump if interrupt pending
153:
154: ;----- Set bit 3 of modem control register
155:
156:     mov     dx, ModemControl        ; Interrupts will be
157:     in      al, dx                   ; acknowledged as soon as
158:     or      al, 08h                 ; this bit is set to 1
159:     out     dx, al                   ; Done!
160:
161: ;----- Empty input buffer again, just in case a stray character
162: ; managed to squeak in
163:
164:     call    EmptyBuffer             ; Empty buffer again
165:
166:     ret                               ; Return to caller
167: ENDP   AsynchInit
168: %NEWPAGE
169: ;-----
170: ; AsynchStop           Uninstall Asynch ISR
171: ;-----
172: ; Input:
173: ;     none
174: ; Output:
175: ;     none
176: ;
177: ;     WARNING: Always call AsynchStop before your program
178: ;     ends or a system crash is inevitable!
179: ;
180: ; Registers:
181: ;     al, dx
182: ;-----
183: PROC   AsynchStop
184:
185: ;----- Mask (disable) 8259 IRQ interrupt
186:
187:     in      al, Ctrl8259_1          ; Read 8259 masks
188:     or      al, DisableIRQ         ; Mask IRQ bit
189:     out     Ctrl8259_1, al         ; Write new masks
190:
191: ;----- Disable 8250 interrupt
192:

```

continues

Listing 10.4. continued

```

193:      mov     dx, LineControl      ; First, read the line control
194:      in      al, dx                ; register, and clear bit
195:      and     al, 07Fh              ; 7, the Divisor Latch Access
196:      out     dx, al                ; Bit, or DLAB
197:      mov     dx, IntEnable         ; With DLAB=0, clear all bits
198:      xor     al, al                ; to disable interrupts
199:      out     dx, al                ; Write new register value
200:
201: ;----- Set bit 3 in modem control register to 0
202:
203:      mov     dx, ModemControl      ; Assign port address
204:      in      al, dx                ; Get current register
205:      and     al, 0F7h              ; Clear bit 3
206:      out     dx, al                ; Output new register value
207:
208: ;----- Interrupts are disabled. Restore saved interrupt vector.
209:
210:      push    ds                    ; Save segment register
211:      mov     ax, 2500h + VectorNum ; Set interrupt vector
212:      mov     dx, [vectorOfs]       ; Get saved offset
213:      mov     ds, [vectorSeg]       ; Get saved segment
214:      int     21h                   ; Set interrupt vector
215:      pop     ds                    ; Restore saved register
216:
217:      ret                           ; Return to caller
218: ENDP   AsynchStop
219: %NEWPAGE
220: ;-----
221: ; AsynchStat          Get status for output
222: ;-----
223: ; Input:
224: ;     none
225: ; Output:
226: ;     ah = line status
227: ;     al = modem status
228: ; Registers:
229: ;     ax, dx
230: ;-----
231: PROC   AsynchStat
232:      mov     ah, 3                  ; Get-status function number
233:      mov     dx, ComPort            ; 0=COM1:, 1=COM2:
234:      int     14h                   ; Call BIOS RS232_IO service
235:      ret                           ; Return to caller
236: ENDP   AsynchStat
237: %NEWPAGE
238: ;-----
239: ; AsynchOut          Output a byte (to output port)
240: ;-----
241: ; Input:
242: ;     al = character (or byte) to output
243: ; Output:
244: ;     none
245: ; Registers:
246: ;     none
247: ;-----

```

```

248: PROC    AsynchOut
249:        push    dx                ; Save modified dx
250:        push    ax                ; Save char in al
251: @@10:
252:        mov     dx, LineStatus      ; Address Line Status Register
253:        in     al, dx              ; Get line status
254:        and    al, 020h            ; Isolate Transmit Holding Reg.
255:        jz     @@10               ; Jump if THRE is not empty
256:        pop     ax                ; Restore character
257:        mov     dx, TxRegister      ; Address transmit register
258:        out    dx, al              ; Output char in al
259:        pop     dx                ; Restore saved dx
260:        ret                       ; Return to caller
261: ENDP    AsynchOut
262: %NEWPAGE
263: ;-----
264: ; AsynchIn                Input a byte (from buffer)
265: ;-----
266: ; Input:
267: ;     none
268: ; Output:
269: ;     al = char from buffer
270: ;
271: ;     Note: if buffer is empty, al will be zero, with
272: ;     no indication that this is not an input value.
273: ;     Precede with call to AsynchInStat to avoid reads
274: ;     from an empty buffer.
275: ;
276: ; Registers:
277: ;     al, bx
278: ;-----
279: PROC    AsynchIn
280:        xor     al, al              ; Preset result to null
281:        mov     bx, [bufTail]      ; Get tail pointer
282:        cmp    bx, [bufHead]      ; Test if buffer is empty
283:        je     @@99               ; Exit if empty (al=0)
284:        mov     al, [byte ptr bx]  ; Else read char from buffer
285:        inc    [bufTail]          ; Advance tail pointer
286:        cmp    [word ptr bufTail], offset buffer + BufSize ; At end?
287:        jb     @@99               ; Jump if not so
288:        mov     [bufTail], offset buffer ; Else reset tail pointer
289: @@99:
290:        ret                       ; Return to caller
291: ENDP    AsynchIn
292: %NEWPAGE
293: ;-----
294: ; AsynchInStat            Get status of input buffer
295: ;-----
296: ; Input:
297: ;     none
298: ; Output:
299: ;     dx = number of bytes (or chars) in buffer
300: ; Registers:
301: ;     dx
302: ;-----

```

continues

Listing 10.4. continued

```

303: PROC    AsynchInStat
304:         mov    dx, [bufHead]           ; Get head pointer
305:         sub    dx, [bufTail]          ; Subtract tail from head
306:         jge    @@99                    ; Jump if result >= 0
307:         add    dx, BufSize             ; Handle negative result
308: @@99:
309:         ret                                ; Return to caller
310: ENDP    AsynchInStat
311: %NEWPAGE
312: ;-----
313: ; AsynchISR    Asynchronous input interrupt service routine
314: ;-----
315: ; Input:
316: ;     none
317: ; Output:
318: ;     none (char read and deposited in buffer)
319: ;
320: ;     NOTE: This version ignores buffer overflows
321: ;
322: ; Registers:
323: ;     none
324: ;-----
325: PROC    AsynchISR
326:         push   ax                       ; Save modified registers
327:         push   bx
328:         push   ds
329:         push   dx
330:
331:         mov    ax, @data                 ; Address local data with ds
332:         mov    ds, ax
333:         mov    dx, RxRegister           ; dx = Receive Register
334:         in     al, dx                   ; Read byte from port
335:         mov    bx, [bufHead]           ; Get head pointer
336:         mov    [byte ptr bx], al       ; Store byte in buffer
337:         inc    bx                       ; Advance head pointer
338:         cmp    bx, offset buffer + BufSize ; Is ptr at end?
339:         jb     @@10                     ; Jump if not
340:         mov    bx, offset buffer       ; Else reset to beginning
341: @@10:
342:         cmp    bx, [bufTail]           ; Check for overflow
343:         jne    @@20                     ; Jump if no overflow
344:         mov    bx, [bufHead]           ; Cancel pointer advance
345: @@20:
346:         mov    [bufHead], bx           ; Save new head pointer
347:         mov    al, EOI                  ; Issue end-of-interrupt to
348:         out    Ctrl18259_0, al         ; 8259 port
349:
350:         pop    dx                       ; Restore saved registers
351:         pop    ds
352:         pop    bx
353:         pop    ax
354:         iret                            ; Return from interrupt
355: ENDP    AsynchISR
356:
357:         END                                ; End of module

```

Running an ASYNCH Demonstration

Listing 10.5, TRM.ASM, demonstrates how to use the ASYNCH package. Although not a complete terminal emulator, TRM is useful for debugging communications with a remote system. It's frequently helpful to be able to see not only normal ASCII text but also every control byte and goes in and out of a communications link. TRM displays normal text normally, but brackets control codes with their ASCII values. For example, a carriage return and line feed are displayed as [13][10]. Just seeing the sequence of control codes coming in from a remote source is often all that's needed to fix communications problems. Assemble and link TRM with the commands:

```
tasm /zi trm
tlink /v trm,, mta
```

NOTE

If you have access to two PCs, connect them with a serial cable and execute TRM on both systems. Then type control codes and press Esc, Enter, and so on to see how TRM displays text and controls. If you don't have two PCs, you might be able to use TRM with a modem, but you'll have to either enter modem-initialization commands manually or use a full-blown terminal program to log on to a remote system before running TRM.

Listing 10.5. TRM.ASM.

```
1: %TITLE "Terminal Emulator -- Copyright (c) 1989,1995 by Tom Swan"
2:
3:      IDEAL
4:
5:      MODEL    small
6:      STACK    1024
7:
8: ;----- From ASYNCH.OBJ
9:      EXTRN    ComPort:abs
10:
11: cr          EQU    13      ; ASCII carriage return
12: lf          EQU    10      ; ASCII line feed
13: bd9600      EQU    0e3h    ; 9600 baud, no parity, 1 stop, 8 bits
14: ExitKey     EQU    100     ; GetCh value for F10
15:
16:
17:      DATASEG
18:
19: exCode      DB        0
20:
```

continues

Listing 10.5. continued

```
21: welcome      DB      cr, lf, 'Terminal Emulator by Tom Swan', cr, lf
22:              DB      cr, lf, 'Configured for 9600 baud. Displays'
23:              DB      cr, lf, 'control codes in brackets for debugging'
24:              DB      cr, lf, 'an RS232 serial line. Press F10'
25:              DB      cr, lf, 'to exit.', cr, lf, lf, 0
26:
27: string        DB      80 DUP (?)      ; Miscellaneous string
28:
29:
30:              CODESEG
31:
32: ;----- From ASYNCH.OBJ
33:              EXTRN   AsynchInit:proc, AsynchStop:proc, AsynchStat:proc
34:              EXTRN   AsynchOut:proc, AsynchIn:proc, AsynchInStat:proc
35:
36: ;----- From KEYBOARD.OBJ
37:              EXTRN   KeyWaiting:proc, GetCh:proc
38:
39: ;----- From BINASC.OBJ
40:              EXTRN   BinToAscDec:proc
41:
42: ;----- From STRIO.OBJ
43:              EXTRN   StrWrite:proc
44:
45: Start:
46:              mov     ax, @data          ; Initialize DS to address
47:              mov     ds, ax             ; of data segment
48:              mov     es, ax             ; Make es = ds
49:
50:              mov     di, offset welcome ; Display welcoming message
51:              call    StrWrite
52:
53: ;----- Initialize baud rate and Asynch package
54:
55:              mov     ah, 0              ; BIOS RS232 init function
56:              mov     al, bd9600         ; configuration
57:              mov     dx, ComPort        ; Port number (0 or 1)
58:              int     14h                ; Call RS232_IO service
59:              call    AsynchInit        ; Initialize asynch package
60:
61: ;----- Perform terminal I/O emulation
62:
```

```

63: Emulate:
64:     call    AsynchInStat      ; Any chars come in yet?
65:     or      dx, dx            ; Check if dx > 0
66:     jz      @@10             ; dx=0, check for keypress
67:     call    AsynchIn         ; Read char from buffer
68:     call    DispChar         ; Display character locally
69:     jmp     Emulate          ; Continue emulation
70: @@10:
71:     call    KeyWaiting       ; Check if key was pressed
72:     jz      Emulate          ; Loop if not
73:     call    GetCh            ; Else get keypress
74:     jnz    @@20             ; Jump if not fn or ctrl key
75:     cmp    al, ExitKey       ; Program-exit key pressed?
76:     je     Exit              ; Jump to Exit if yes
77: @@20:
78:     call    AsynchOut        ; Else send char on its way
79:     jmp     Emulate          ; Loop until done
80:
81: ;----- End of emulation.  Deinitialize Asynch package and exit.
82:
83: Exit:
84:     call    AsynchStop       ; Halt Asynch package
85:     mov    ah,04Ch           ; DOS function: Exit program
86:     mov    al,[exCode]       ; Return exit code value
87:     int    21h              ; Call DOS. Terminate program
88:
89: %NEWPAGE
90: ;-----
91: ; DispChar/OneChar      Display any ASCII value
92: ;-----
93: ; Input:
94: ;     al = ASCII value (0..255)
95: ; Output:
96: ;     none
97: ;
98: ;     NOTE: Control codes are displayed as [13] [10] etc. for
99: ;     debugging a serial I/O line.
100: ; Registers:
101: ;     ax, cx, dl, di
102: ;-----
103: PROC    DispChar
104:     cmp    al, 32            ; Is character a control?
105:     jae    OneChar          ; Jump if not
106:
107: ;----- Display bracketed control codes
108:
109:     xor    ah, ah            ; Convert al to 16-bit value
110:     mov    cx, 1             ; Specify at least one char
111:     mov    di, offset string ; Address string variable
112:     call   BinToAscDec       ; Convert to string
113:     mov    al, '['           ; Display [ char
114:     call   OneChar           ; Display char in al
115:     call   StrWrite          ; Display ctrl-code string
116:     mov    al, ']'           ; "Fall through" to OneChar
117:

```

continues

Listing 10.5. continued

```

118: PROC    OneChar
119:         mov     dl, a1                ; Assign char to dl
120:         mov     ah, 2                ; DOS output-char function
121:         int     21h                 ; Call DOS to display char
122:         ret                          ; Return to caller
123: ENDP    OneChar
124:
125: ENDP    DispChar
126:
127:         END     Start                ; End of program / entry point

```

How TRM Works

Listing 10.5, TRM.ASM, demonstrates how to use the ASYNCH package routines, described in detail after this section. Lines 55-58 call BIOS function 14h to initialize the primary serial port, passing the baud rate and other parameters in register a1. The default setting used here is 9600 baud, no parity, 1 stop bit, and 8 data bits (see line 13).

Table 10.3 lists the meanings of the bits in the 8-bit value passed in a1 with ah = 0 and dx set to the ComPort value to BIOS interrupt 14h. The top of the table lists the bit numbers and meanings for each field. Below this are the bit settings you can use to select various configuration parameters.

Table 10.3. Interrupt 14h Configuration Bits.

7	6	5 (baud rate)	4	3 (parity)	2 (stop bits)	1	0 (data bits)
0	0	0 (110)	0	0 (none)	0 (1)	0	0 (???)
0	0	1 (150)	0	1 (off)	1 (2)	1	0 (7)
0	1	0 (300)	1	1 (even)		1	1 (8)
0	1	1 (600)					
1	0	0 (1200)					
1	0	1 (2400)					
1	1	0 (4800)					
1	1	1 (9600)					

Line 59 calls `AsynchInit` to install the `AsynchISR` interrupt handler. Be aware that incoming data will be stored in the input buffer as soon as `AsynchInit` finishes—so don't delay checking for incoming data too long after this step. The loop at lines 63-79 checks for input, reads characters from the input buffer, checks for local key presses, and exits when you press F10. (Pressing Esc to end is inappropriate in this program because you may want to pass an Esc character to a remote device.) Subroutine `DispChar` at lines 90-125 displays an ASCII value or control code.

`DispChar` demonstrates an assembly language trick that's worth learning. Examine the nested procedure `OneChar` at lines 118-123, which displays a single character by calling DOS function 2. Above this, line 114 (in the outer procedure) calls `OneChar`. But look closely at the entire `DispChar` procedure—there is only one return instruction at line 122, despite the fact that there are two subroutines here. This is not a mistake! After the `mov` at line 116, the program “falls through” to the `OneChar` subroutine, running this code as an extension of the outer procedure `DispChar`. Earlier, however, `DispChar` calls this inner portion of itself as a subroutine. When the `call` at line 112 executes, the `ret` at line 122 passes control back to line 113. When the program falls through into `OneChar` after line 116, this same `ret` instruction passes control back to the code that originally called `DispChar`. When using this trick, be sure to document your program carefully so that others will understand what's happening.

How To Use the ASYNCH Package

`ASYNCH.ASM` contains seven routines to read and write asynchronous serial data at any baud rates supported by your hardware. (Unless stated otherwise, line numbers in the following sections refer to Listing 10.4.) The seven routines are:

- | | |
|------------------------------|---------------------------------------|
| 1. <code>AsynchInit</code> | Initializes the ASYNCH package |
| 2. <code>AsynchStop</code> | Deinitializes the ASYNCH package |
| 3. <code>AsynchStat</code> | Returns the status of the serial port |
| 4. <code>AsynchOut</code> | Writes 1 byte to the serial port |
| 5. <code>AsynchIn</code> | Reads 1 buffered input byte |
| 6. <code>AsynchInStat</code> | Returns status of input buffer |
| 7. <code>AsynchISR</code> | Inputs interrupt service routine |

Programs never directly call `AsynchISR`—this is the interrupt service routine that automatically handles input from a serial port. Most of the time, you'll use the other six routines in this order:

1. Call ROM BIOS interrupt 14h to set the baud rate. Because PCs already have this initialization code built in, ASYNCH does not duplicate this programming.
2. Call `AsynchInit` to initialize the ASYNCH package and install the `AsynchISR` code.
3. Use `AsynchStat` to determine the status of the serial port—for example, to see if the hardware is ready to accept a character for output.
4. Call `AsynchOut` to send characters to the remote system.
5. Call `AsynchInStat` to find out if any characters are stored in the input buffer.
6. If `AsynchInStat` reports at least one character in the buffer, call `AsynchIn` to extract a character from the buffer.
7. Call `AsynchStop` to detach the `AsynchISR` code and halt interrupt-driven input.

NOTE

Be sure to call `AsynchStop` before your program ends, or a system crash is practically guaranteed. Leaving `AsynchISR` (or any other ISR) in memory after passing control back to `COMMAND.COM` is sure to cause serious problems.

ASYNCH Equates and Variables

`ASYNCH.ASM` assigns a series of equates for addressing two integrated circuits: an 8250 asynchronous I/O chip and the 8259 interrupt controller that you learned how to control earlier in this chapter. Line 9 determines whether the package accesses the primary (`ComPort = 0`) or secondary (`ComPort = 1`) serial ports available on most PCs. Line 7 declares this equate public. In your own programs, import the `ComPort` value by adding this line to your other equates:

```
EXTRN ComPort:abs
```

Lines 11–25 assign values to four constants depending on the value of `ComPort`. Notice how errors are handled at lines 22–25. Try assembling the program with `ComPort` equal to 3 to see the effect of these statements. First, line 23 displays an error message with the `DISPLAY` directive. Then line 24 executes `ERR`, displaying Turbo Assembler's user error message and preventing the `.OBJ` file from being created.

Lines 29–36 assign additional equates for reading and writing registers located at various offsets from the base `Port` value, which is initialized at either line 12 or 18. The program uses these values to control the 8250 chip directly without calling DOS or BIOS routines. A few more equates at lines 40–43 reference the 8259 interrupt controller as explained before.

You can change `BufSize` (line 43) to increase or decrease the size of the input buffer. The best size depends on the type of communications program you're writing. A program that reads and writes lines of text might get away with a small buffer, perhaps no larger than 256 bytes. A terminal emulator should probably be able to store the equivalent of several text screens in memory. The default value 2048 is a reasonable compromise.

Ring Around the Asynch Buffer

The variables at lines 50–52 reserve space for the input buffer. Two pointers `bufHead` and `bufTail` address bytes in this buffer. When these variables point to the same address, the buffer is empty. New bytes are stored in the buffer at the location addressed by `bufHead`. Bytes are extracted from the buffer at the location addressed by `bufTail`. These two pointers are incremented until reaching the end of the buffer, when they are reset to the beginning of

this variable. As data flows in and out, `bufHead` and `bufTail` chase each other around the buffer space, creating a structure called a *queue* in which the oldest data in the buffer is the first to leave. Study lines 280-346 to see how this structure is implemented in `ASYNCH`.

Asynchinit (84-167)

`AsynchInit` initializes communications by first emptying the input buffer with a call to a private subroutine `EmptyBuffer` at lines 61-82. Next, the current interrupt vector for the selected I/O port is saved in two variables `vectorSeg` and `vectorOfs`. (See lines 112-115.) Even though it's unlikely that another communications program would be running at the same time as yours, it's a good policy to save and restore all changed interrupt vectors. After this step, lines 116-120 install the new `AsynchISR` code.

The next instructions (lines 126-159) configure the 8250 and 8259 registers. As you can see, several steps are required to switch on interrupts and clear registers. These notes will help explain the programming in this section:

- The interrupt request line (IRQ) for the appropriate interrupt type must be enabled, allowing the 8259 PIC to pass this interrupt signal to the processor. (See lines 126-128 and Table 10.1.) Unless this is done, interrupts from 8250 serial I/O chip would be blocked from the processor's INTR line.
- Next, the 8250 serial I/O chip must be told to generate an interrupt signal whenever a new byte of data comes in from the remote source. (See lines 132-138.) This signal is sent to the 8259 PIC, which, as the previous note explains, passes the interrupt request to the processor.
- Several 8250 registers are cleared (see lines 142-152) by reading them with `in` statements. When the interrupt will be allowed to occur. (Some references name this bit "OUT2." Another bit "OUT1" can be used to reset an internal Hayes compatible modem.) This step—acting as a kind of communications ignition switch—allows the `AsynchISR` to begin receiving input as soon as the out at line 159 is executed.
- Just in case a stray character got into the input buffer during any of the previous steps, line 164 calls `EmptyBuffer` again to empty the input buffer.

After executing this intricate sequence, the next character to come into the 8250 will cause an interrupt signal to be sent to the 8259 PIC, which will pass the signal to the 8086 processor, which—after completing any in-progress instruction—will transfer control to the vector for the interrupt type also passed to the 8086 by the 8259 PIC. The next effect of these complex actions is to cause the `AsynchISR` code at lines 312-355 to read and deposit one character into the input buffer.

AsynchStop (169-218)

AsynchStop reverses what AsynchInit does. Always call AsynchStop before your program ends. First, lines 187-189 disable interrupts by resetting the IRQ bit in the 8259 interrupt controller. Although this step alone prohibits future 8250 interrupts from reaching the processor, to be on the safe side, lines 193-206 disable 8250 interrupts and reset bit 3 of the modem control register, putting these registers back to their normal noninterrupt states. The final instructions in this procedure restore the saved interrupt vector (lines 210-215), detaching the AsynchISR code.

AsynchStat (220-236)

AsynchStat returns the status of the 8250 chip. Instead of directly accessing 8250 registers, the procedure calls BIOS routine 14h. Table 10.4 lists the bits and their meanings in ah and al following a call to AsynchStat.

One way to use AsynchStat is to test ah bit 5 before writing characters. After calling AsynchStat, if this bit equals 0, then a previous character has not yet been sent on its way. You might call this procedure in a loop such as:

```
@@10:
    call  AsynchStat    ; get Line status
    test  ah, 020h     ; Is bit 5 = 1?
    jz    @@10         ; No, jump if bit 5 = 0
    call  OutputChar   ; Call output routine
```

Table 10.4. AsynchStat Results.

<i>Line Status Register</i>		<i>Modem Status Register</i>	
<i>ah</i>	<i>bit = 1</i>	<i>al</i>	<i>bit = 1</i>
0	Data ready	0	Delta clear to send
1	Overrun error	1	Delta data set ready
2	Parity error	2	Trailing edge ring detect
3	Framing error	3	Delta RX line detect
4	Break interrupt	4	Clear to send
5	TX holding reg empty	5	Data set ready
6	TX shift reg empty	6	Ring indicator
7	Time out	7	RX line signal detect

Note: TX=Transmit, RX=Receive

AsynchOut (238-216)

AsynchOut could call AsynchStat for the line status, but lines 251-255 demonstrate another way to do the same thing, directly reading the line status port with an `in` instruction. Only when bit 5 is equal to 1, indicating that the transmit holding register is empty and ready to receive another character, is the `out` instruction at line 258 allowed to send the character in `al` to the output.

AsynchIn (263-291)

Call `AsynchIn` to read one character from the input buffer. Because the procedure has no effect if the buffer is empty, you should precede `AsynchIn` with a call to `AsynchInStat`, described next. Notice how lines 285-288 increment `bufTail`, wrapping the pointer around to the front of the buffer if necessary.

AsynchInStat (293-310)

`AsynchInStat` simply subtracts `bufTail` from `bufHead`, returning in `dx` the number of characters held in the input buffer. Normally, you'll just check if `dx` is 0 after calling `AsynchInStat`. If `dx` is not 0, call `AsynchIn` to read one character from the buffer. Remember always that characters may be coming into the buffer even as `AsynchInStat` is executing; therefore, the value returned in `dx` may not be exact by the time you examine the register.

The instruction at line 307 finds the correct positive value of a negative result from the subtraction at line 305. This is needed because the `bufTail` and `bufHead` pointers could be greater or less than each other at any time except when the buffer is empty.

AsynchISR (312-355)

You should be able to follow the programming in `AsynchISR` by reading the comments. Notice how the all important end-of-interrupt signal is given to the 8259 PIC (lines 347-348), allowing future interrupts to be processed. Line 334 reads a character by executing an `in` instruction on the 8250 receive-data register (`RxRegister`). The other instructions stuff the character into the input buffer, advancing `bufHead` unless the buffer is full.

NOTE

Error handling in `AsynchISR` is minimal at best. If the input buffer overflows, subsequent characters are simply ignored. This means that your program must call `AsynchIn` often enough to prevent overflows. If this is not possible, you will have to modify `AsynchISR` to: a) set a flag

indicating that an overflow has occurred and b) send a stop signal to the remote system to prevent new input. Normally, the stop signal must be sent several characters before overflow occurs to give the remote system's software a chance to detect the overflow condition. Of course, you then have to send a start signal to the remote system to begin receiving input again. There isn't room here to list the code for all of this—consult Bibliography for an excellent reference on the subject of serial communications.

Debugging with Interrupts

The breakpoint interrupt, type 3, is reserved for debugging. (See Table 10.2.) Although Turbo Debugger lets you press F2 to set a breakpoint, halting a program just before executing a particular instruction, you can also cause a temporary halt by inserting the line:

```
int 3 ; Set breakpoint
```

When you run a program with this instruction under control of Turbo Debugger (and most other debuggers), the program halts when `int 3` executes. When running the program from DOS, the breakpoint has no effect because the sector for interrupt type 3 normally points to a plain `iret` instruction in DOS. You can insert as many `int 3` instructions as you like into a program. When setting many breakpoints in a large program, you may find this easier to do than other methods provided by Turbo Debugger.

Single Stepping

Setting the trap flag (`tf = 1`) causes the processor to run in a single-step mode. In this state, nearly every instruction is followed by a type 1 automatic interrupt signal, allowing an ISR to examine registers and memory, display values, and monitor other program effects. Installing your own ISR for this interrupt number gives you a way to gain control of an executing program after almost every instruction.

NOTE

Turbo Debugger sets `tf` for its own single-step command, so don't use these techniques in programs that you want to run under control of the debugger. The same is true for other debuggers, too.

A few instructions do not cause type 1 interrupts to occur. These instructions include all prefixes such as `rep`, assignments via `mov` and `pop` to segment registers (which, as you recall, temporarily turns off interrupts, including type 1) and the `wait` instruction. But after other instructions execute with `tf = 1`, these three steps are taken:

1. The flags, cs, and ip registers are pushed onto the stack
2. The tf and if flags are cleared
3. The ISR at interrupt type 1's vector is executed

Because the second step clears both the trap and interrupt flags, the single-step ISR does not run in single-step mode; therefore, you do not have to be concerned that this ISR will attempt a self-examination by interrupting itself, even if you allow interrupts to be recognized (as you probably should) by executing `sti` in the ISR. When the ISR finishes, the `iret` instruction restores the flag settings, throwing the processor back into single-step mode.

Setting and Clearing tf

Because there are no built-in instructions for setting and clearing `tf`, another method must be found. At first, you might be tempted to try using the `lahf` and `sahf` instructions, which transfer values between some processor flags and `ah`. But this doesn't work because `lahf` and `sahf` affect only the `af`, `cf`, `pf`, `sf`, and `zf` flags—`of`, `df`, `if`, and `tf` can't be changed with `sahf`.

One answer to the problem is to push the flags onto the stack with `pushf`, pop the flag values into `ax`, modify the `tf` bit, push the flags back onto the stack and execute `popf`, transferring the modified flag values back into the flag register:

```
pushf          ; Push flags onto the stack
pop    ax      ; Transfer flags into ax
or     ax, 0100h ; Set tf bit = 1
push   ax      ; Push modified flags onto the stack
popf          ; Pop stack into flag register
```

To reset `tf`, disabling single stepping, change the `or` instruction to `and ax, 0FEFFh`. The only problem with this method is that the instructions to disable single stepping must execute in single-step mode. Although this probably won't cause any harm, there is a more elegant solution—enable and disable the trap flag inside the single-step ISR, which as you recall, executes at full speed.

Listing 10.6, `SINGLE.ASM`, demonstrates this method, placing the processor in single-step mode for a sample subroutine that counts to 100. During this time, if a local counter reaches 50, the single-step ISR pauses to display a message. Pressing any key continues the program. This simulates how to write a single-step ISR to examine variables in memory, which you might do to learn which sections of a buggy program are changing those variables. (Turbo Debugger has commands for performing similar operations, of course, but knowing how to install your own debugging code is still a useful technique.) Assemble and link `SINGLE.ASM` with the commands:

```
tasm single
tlink single,,, mta
```

NOTE

Do not execute SINGLE in Turbo Debugger (or in any other debugger). If the debugger throws the processor into single-step mode, a conflict may occur.

Listing 10.6. SINGLE.ASM.

```

1: %TITLE "Single-Step (Trap) Demo -- Copyright (c) 1989,1995 by Tom Swan"
2:
3:         IDEAL
4:
5:         MODEL    small
6:         STACK    256
7:
8: cr      EQU      13           ; ASCII carriage return
9: lf      EQU      10          ; ASCII line feed
10: Trapping EQU      0         ; "Single-stepping is enabled"
11: TurnOnTrap EQU      1       ; Code to enable single-step
12: TurnOffTrap EQU      2      ; Code to disable single-step
13:
14:
15:         DATASEG
16:
17: exitC   DB      0
18:
19: spaces  DB      '    ', 0    ; String of 4 blank characters
20:
21: offMsg  DB      cr, lf, 'Single-step trap is off', cr, lf, 0
22: onMsg   DB      cr, lf, 'Single-step trap is on', cr, lf, 0
23: pauseMsg DB      'Press any key to continue...', 0
24: countMsg DB      cr, lf, lf, 'Count = 50!', cr, lf, 0
25:
26: trapSwitch DB      0         ; Trap enable/disable switch
27: string    DB      40 DUP (?) ; Miscellaneous string
28: count     DW      ?         ; For Counter subroutine
29: trapSeg   DW      ?         ; Old int type 1
30: trapOfs   DW      ?         ; vector address
31:
32:
33:         CODESEG
34:
35: ;----- From STRIO.OBJ, BINASC.OBJ, KEYBOARD.OBJ
36: EXTRN   StrWrite:proc, NewLine:proc, BinToAscDec:proc
37: EXTRN   GetCh:proc
38:
39: Start:
40: mov     ax, @data           ; Initialize DS to address
41: mov     ds, ax              ; of data segment
42: mov     es, ax              ; Make es = ds
43:
44: ;----- Save int type 1 vector and reassign to Stepper ISR
45:

```

```

46:      mov     ax, 3501h          ; Get int type 1 vector
47:      int     21h              ; Call DOS
48:      mov     [trapSeg], es     ; Save segment value
49:      mov     [trapOfs], bx     ; Save offset value
50:      push    ds               ; Save current ds register
51:      mov     ax, 2501h        ; Set int type 1 vector
52:      push    cs               ; to the address of
53:      pop     ds               ; the Stepper ISR
54:      mov     dx, offset Stepper
55:      int     21h
56:      pop     ds               ; Restore ds
57:      push    ds               ; Set es equal to ds
58:      pop     es
59:
60: ;----- Execute sample code at full speed
61:
62:      mov     di, offset offMsg  ; Display "Trapping is off"
63:      call    Counter           ; Call sample subroutine
64:
65: ;----- Execute sample code in single-step mode
66:
67:      mov     di, offset onMsg   ; Display "Trapping is on"
68:      mov     [trapSwitch], TurnOnTrap ; Tell ISR to turn
69:      int     1                 ; on trapping
70:      call    Counter           ; Call sample subroutine
71:      mov     [trapSwitch], TurnOffTrap ; Tell ISR to turn
72:                                     ; off trapping
73: ;----- Reexecute sample code at full speed
74:
75:      mov     di, offset offMsg  ; Display "Trapping is off"
76:      call    Counter           ; Call sample subroutine
77:
78: Exit:
79:      push    ds               ; Save current ds register
80:      mov     ax, 2501h        ; Reset int type 1 vector
81:      mov     ds, [trapSeg]     ; to the address saved
82:      mov     dx, [trapOfs]     ; at trapSeg and trapOfs
83:      int     21h
84:      pop     ds               ; Restore ds
85:      mov     ah, 04Ch          ; DOS function: Exit program
86:      mov     al, [exitC]       ; Return exit code value
87:      int     21h              ; Call DOS. Terminate program
88:
89:
90: ;----- Subroutine: Displays string, pauses, and counts to 100
91:
92: PROC Counter
93:      call    StrWrite          ; Display id message
94:      call    Pause            ; Wait for keypress
95:      mov     [count], 0       ; Zero count

```

continues

Listing 10.6. continued

```

96: @@10:
97:     inc    [count]           ; count <- count + 1
98:     mov    ax, [count]       ; Convert count to string
99:     mov    cx, 4             ; Minimum string size
100:    mov    di, offset string
101:    call   BinToAscDec
102:    call   StrWrite           ; Display string
103:    mov    di, offset spaces  ; Display 4 blanks
104:    call   StrWrite
105:    cmp    [count], 100      ; Repeat until count = 100
106:    jb    @@10
107:    ret                                ; Return to caller
108: ENDP   Counter
109:
110:
111: ;----- Subroutine: Display message and wait for keypress
112:
113: PROC   Pause
114:     mov    di, offset pauseMsg ; Display pause message
115:     call   StrWrite
116:     call   GetCh               ; Wait for a keypress
117:     call   NewLine            ; Start new display line
118:     ret                                ; Return to caller
119: ENDP   Pause
120:
121:
122: %NEWPAGE
123: ;-----
124: ; Stepper      Single-Step trap ISR
125: ;-----
126: ; Input:
127: ;     [trapSwitch] = TurnOnTrap
128: ;           Single-step mode enabled
129: ;     [trapSwitch] = TurnOffTrap
130: ;           Single-step mode disabled
131: ;     [trapSwitch] = ???
132: ;           no action
133: ; Output:
134: ;     none
135: ; Registers:
136: ;     none
137: ;-----
138: PROC   Stepper
139:     sti                                ; Allow interrupts
140:     push   bp                          ; Save current bp register
141:     mov    bp, sp                      ; Address stack with bp
142:     push   ax                          ; Save all registers
143:     push   bx
144:     push   cx
145:     push   dx
146:     push   di
147:     push   si
148:     push   ds
149:     push   es
150:

```

```

151: ;----- Address local data with ds, es
152:
153:     mov     ax, @data           ; Initialize DS to address
154:     mov     ds, ax             ; of data segment
155:     mov     es, ax             ; Make es = ds
156:
157: ;----- Test trapSwitch to turn single-step mode on/off
158:
159:     cmp     [trapSwitch], TurnOnTrap
160:     jne     @@10
161:     or      [word bp+6], 0100h  ; Set tf (enable trap)
162:     mov     [trapSwitch], Trapping ; "Trapping is enabled"
163:     jmp     @@99                ; Exit
164: @@10:
165:     cmp     [trapSwitch], TurnOffTrap
166:     jne     @@20
167:     and     [word bp+6], 0FEFFh  ; Reset tf (disable trap)
168:     jmp     @@99                ; Exit
169:
170: @@20:
171:
172: ;----- Insert single-stepping trap code here
173:
174:     cmp     [count], 50         ; Is count = 50
175:     jne     @@99                ; If not, exit
176:     mov     di, offset countMsg ; Else display count message
177:     call    StrWrite
178:     call    Pause                ; And wait for keypress
179:     inc     [count]              ; To allow program to continue
180:     call    NewLine
181:
182: @@99:
183:     pop     es                   ; Restore all registers
184:     pop     ds
185:     pop     si
186:     pop     di
187:     pop     dx
188:     pop     cx
189:     pop     bx
190:     pop     ax
191:     pop     bp
192:     iret                        ; Return from interrupt
193: ENDP   Stepper
194:
195:     END     Start                ; End of program / entry point

```

How SINGLE Works

When you run SINGLE, you first receive a message that the single-step trap is off. Press Enter and the program then calls a subroutine to count from 1 to 100 at full speed. After this, single-step mode is turned on by setting `tf`. Pressing Enter again calls the counting subroutine, which as you can see, runs much more slowly because every instruction is interrupted, giving the custom ISR control. When this ISR detects a count of 50, it halts the counting and asks you to press any key. Press Enter to resume operation. To show that you can return

from single stepping to full speed at any time, the program resets the trap flag. Press Enter a final time to count once again at top speed.

Three equates in `SINGLE`—`Trapping`, `TurnOnTrap`, and `TurnOffTrap` at lines 10-12—define three states recognized by the Stepper ISR (lines 138-193). Byte variable `trapSwitch` at line 26 holds one of these three values, which alter the way Stepper runs. If `trapSwitch` equals `TurnOnTrap`, then Stepper enables single stepping by setting the `tf` flag. If `trapSwitch` equals `TurnOffTrap`, then Stepper disables single stepping by resetting `tf`. If `trapSwitch` equals `Trapping`, then Stepper runs a small section of code that examines the global count variable (see line 28). When `count` equals 50, the program displays a message and asks you to press a key.

`SINGLE` begins by saving the current vector for interrupt type 1 and then changing this vector to address the custom Stepper ISR (lines 46-58). Next, the program calls the Counter subroutine (lines 92-108), which counts to 100, displaying columns of values on screen. After this first call to `Counter`, which runs at full speed, the `trapSwitch` is set to `TurnOnTrap` (lines 67-68). Line 69 then immediately forces a trap to interrupt type 1 with the software interrupt command:

```
int    1
```

This causes the Stepper ISR to begin running for the first time. When the ISR senses that the `trapSwitch` is set to `TurnOnTrap` (lines 159-163), an `or` instruction modifies the `tf` flag stored on the stack by the `int` instruction, using the `bp` register method for addressing stack variables. After setting the flag bit on the stack, the next `iret` instruction, which restores the actual flags from the saved values on the stack, throws the processor into single-step mode. To do this, line 162 changes the `trapSwitch` to `Trapping`, and the program jumps to exit the ISR, skipping the rest of the code.

As soon as the `iret` at line 192 executes, the program starts running in a single-step mode. Interrupts of type 1 are now automatically generated by the processor after nearly every instruction, causing the Stepper ISR to run at this frequency. But this time, because the `trapSwitch` was set to `Trapping`, the jump at line 160 bypasses the code that sets `tf`, executing the main ISR body at lines 165-180. The first job is to test the `trapSwitch` again to see if the program is requesting single-step mode to be turned off. If so, the `and` instruction at line 167 modifies the flag bit on the stack (similar to the way this bit was set earlier) and jumps to exit the ISR. Upon executing the `iret` this time, `tf` remains off (it's off during the ISR, remember), causing the program to continue at full speed.

If the `trapSwitch` equals `Trapping`, then line 166 jumps to the instructions at lines 170-180, which examine the `count` variable and pause if this value equals 50. (To prevent pausing more than once, line 179 increments `count`.) By replacing only this section (lines 174-180), you can use the Stepper ISR in your own programs to examine whatever you want after almost every instruction executes. To do this, copy lines 10-12, 26, and the Stepper ISR at lines 123-193. Remove lines 174-180 and insert your own test instructions. Then, to enable single stepping, use the instructions:

```
mov    [trapSwitch], TurnOnTrap
int    1
```

To disable single stepping, returning the processor to full speed, execute:

```
mov    [trapSwitch], TurnOffTrap
```

NOTE

Before returning to DOS, you must disable single stepping in any program that sets the `tf` flag. Failure to follow this rule could hang the computer, forcing you to reboot. If the program ends unexpectedly, reboot as soon as possible—if you are able.

Summary

An interrupt is a signal that causes an executing program to pause, run a special subroutine called an interrupt service routine (ISR), and then resume normal execution. In the 8086 processor family, there are two kinds of interrupt signals: external and internal. External interrupts can occur at any time. Internal or software interrupts occur only when programs execute an `int` or `into` instruction or when certain conditions occur, such as a divide-by-zero exception.

Because an external interrupt signal can occur at any time, external ISRs must preserve all registers. Flags are preserved automatically by the processor when it recognizes an interrupt signal. Internal ISRs may pass values in registers back to programs, similar to the way common subroutines operate. In either case, interrupts are never processed until the current instruction finishes.

Maskable interrupts can be temporarily disabled with `c1i` and enabled with `sti` instructions. Nonmaskable interrupts can't be disabled. (You may be able to disable circuits that generate nonmaskable interrupts.) On PCs, externally generated interrupts are piped to an 8259 interrupt controller (PIC) chip, which resolves conflicts between multiple interrupts and passes interrupt signals to the processor's single `INTR` input line.

Interrupt vectors are stored in low memory at segment 0000, from offset 0000h to 03ffh. You can install your own ISR code by inserting the address of your routine into the correct vector location for the appropriate interrupt number. DOS contains functions to return interrupt vector values and to insert new values in the interrupt vector table. If you change any vectors, it's your responsibility to restore their original values before your program ends.

Divide errors occur when the divisor to `div` or `idiv` is 0, or when the result of the division is too large to fit in the 8- or 16-bit destination. A divide error causes an automatic interrupt type 0 to be generated, executing the ISR at the vector stored in location 0000:0000 and usually halting the program. This condition can be prevented by installing a custom ISR to trap the interrupt. But the job is complicated by subtle differences between 8086/88 and 80286/386 and later processors. Solving this problem is tricky, but it can be done as an example in this chapter demonstrates.

A good method to write programs to communicate with remote computers over a serial line or through a modem is to use interrupt-driven routines to capture data as it comes in, thus

eliminating the problems that can occur when a program pauses for a disk write or another operation for too long, resulting in lost data. The `ASYNCH` package in this chapter demonstrates the techniques. An accompanying terminal program helps debug a serial interface line.

Although Turbo Debugger can run programs in single-step mode, it's useful to know how to install your own single stepper. The `SINGLE` program in this chapter illustrates how to do this and can serve as a shell for your own single-stepping debugging sessions.

Exercises

- 10.1. Why is it important to save register values in an external ISR?
- 10.2. What does `iret` do?
- 10.3. What instruction disables interrupts? What instruction enables interrupts? What do these instructions do? In an ISR, what are logical locations for these instructions?
- 10.4. Write code to install a new ISR named `NewISR` for interrupt number 01Ch. Write code to restore the original interrupt vector before the program ends.
- 10.5. Can an interrupt service routine be interrupted by another interrupt?
- 10.6. After processing an externally generated interrupt on PCs, what instructions must you execute to ensure that future interrupts are recognized?
- 10.7. The external Print Screen interrupt on PCs is number 5. Write a subroutine that prints the screen. It should not be necessary to press the `PrtSc` key!
- 10.8. What is the difference between a divide-fault interrupt on 8086/88 and 80286/386 and later processors?
- 10.9. What instruction can you use to insert breakpoints in programs?
- 10.10. Write instructions to set the trap flag, using a method different from the two that are described in this chapter.

Projects

- 10.1. Rewrite the `TRM` program, adding subroutines to emulate a full CRT terminal.
- 10.2. Improve the `ASYNCH` module by adding code to send a stop signal (usually ASCII 013h or `Ctrl-S`) before the input buffer overflows. Also add code to send a start signal (usually ASCII 011h or `Ctrl-Q`), allowing input to again be received.
- 10.3. [Advanced] Add interrupt-driven output routines to `ASYNCH.ASM`. (Note: You'll need additional references for the 8250 and 8259 chips to accomplish this project.)
- 10.4. Write a version of the divide-fault program (`DIV286.ASM`) that uses conditional compilation to create a program for all processor models.
- 10.5. Convert the `SINGLE` program to a library module for adding single-step debugging code to any program. (Hint: Use the `call bx` method from Listing 9.5, `DR.ASM`, line 91, to call custom code from inside the single-step ISR.)
- 10.6. Write a program to print a report of all interrupt numbers and vector addresses.

11

CHAPTER

Advanced Topics

- Advancing Your Assembly Language Knowledge, 424
- Binary Coded Decimals, 424
- A BCD Math Package, 429
- Advanced Separate Assemblies, 438
- Processing Tables, 442
- Declaring Segments the Hard Way, 446
- The SEGMENT Directive, 447
- The ASSUME Directive, 451
- The GROUP Directive, 452
- Using Segments in Programs, 453
- Far Data Segments, 458
- Programming the 80286 and Later Processors, 461
- Programming the 80386, 468
- The VERSION Directive, 474
- Enumerated Data Types, 475
- Getting SMART, 478
- Some Additional Instructions, 481
- Summary, 486
- Exercises, 488
- Projects, 489

Advancing Your Assembly Language Knowledge

In the preceding chapters, you learned how to use most of the 8086 instruction set, and you entered and ran many examples illustrating various assembly language techniques. At this point, you're probably ready to begin writing your own programs—if you haven't done so already. But, we still have some fertile ground to cover, including a few new instructions for business mathematics and table processing, special instructions in 80286, 80386 and later-model processors, and directives that simplify sharing data among multiple program modules.

Many of you may someday tackle a large assembly language project that requires special data-segment handling not provided by the simplified memory models used by most programs in this book. For this, you'll probably want to specify segments the hard way, telling Turbo Assembler and Turbo Linker the exact size and location of data and code segments. You may also want to attach a *far* data segment—a quick way to double your program's data capacity. This chapter covers these and other subjects, collected here in a kind of grab bag of tips, hints, and programs for advanced assembly language programming.

Binary Coded Decimals

Numbers in business application programming must be large and precise—two requirements that pose special problems for assembly language programmers accustomed to dealing with relatively small binary values. For example, representing dollar amounts with word integers ranging from $-32,768$ to $+32,767$ won't do—after adding an imagined decimal point, amounts are limited to the penny-pinching range, $-\$327.68$ to $+\$327.67$. 32-bit doubleword values ranging from $-\$21,474,836.48$ to $+\$21,474,836.47$ are better, but may still be too restrictive for businesses that need to keep running totals on inventory and payroll and for other accounting purposes. Also, converting such double-precision values to and from ASCII is time consuming. Floating-point representations are even worse, introducing the possibility of round-off errors, which may be acceptable for scientific measurements that allow for such errors, but which are unacceptable in business.

One answer to these problems is to store numbers in binary coded decimal (BCD) form, which is easily converted to and from ASCII, and which can store very large numbers containing up to 20 digits for a maximum dollar amount of $\$999,999,999,999,999,999.99$ (about a trillion trillion). There are two main variations of BCD numbers:

- *Packed BCD numbers* store 2 digits per byte, usually with individual digits in high-to-low order, but with the bytes in low-to-high order.
- *Unpacked BCD numbers* store 1 digit per byte, ordering the bytes in either low-to-high or high-to-low sequence.

Packed BCD numbers are probably the most common, storing 2 decimal digits in each byte—1 digit in the upper 4 bits and the other in the straight binary. Because 4 bits can represent binary values from 0 to 15, using 4 bits to represent numbers ranging from only 0 to 9 wastes a little space in each byte. (Another way to look at this is to consider that a packed BCD byte can store values from only 0 to 99 while a binary byte can normally represent values from 0 to 255.)

Unpacked BCD numbers are mostly used as an intermediate form for converting packed BCD numbers to and from ASCII characters. As you'll see in a moment, there is a nearly direct relationship between ASCII and unpacked BCDs. Unfortunately, this format is even more inefficient, capable of representing values ranging from only 0 to 9 in a single byte.

BCDs in Memory

You can create packed and unpacked BCD variables in memory with the `dt` and `db` directives. The `dt` directive creates a 10-byte, 20-digit, packed BCD value. For example:

```
packed    dt    81659247    ; Packed BCD number
```

This command always allocates 10 bytes, in this case, storing the value 0000000000081659247 at label `packed`. Ignoring leading zeros, Figure 11.1 shows how this value is stored in memory. The lower two digits (4 and 7) occupy the first byte, the next higher two digits (9 and 2) occupy the second byte, and so on. As you'll see in a moment, this semireversed ordering makes it easy to perform mathematics operations on two packed BCD numbers.

Turbo Assembler lacks directives for creating unpacked BCD numbers, although you can use `db` if you're careful. For example, here is the same value, 81,659,247, allocated as an unpacked 20-byte BCD number:

```
unpacked  db    7,4,2,9,5,6,1,8,0,0    ; Unpacked BCD number
           db    0,0,0,0,0,0,0,0,0,0
```

Figure 11.2 illustrates how this value appears in memory, again ignoring leading digits. Like the packed format (Figure 11.1), the digits are reversed, an arbitrary choice that depends only on how other software uses the unpacked values. You can just as easily store unpacked BCDs the other way around—as long as you're prepared to write the necessary code to handle this format.

NOTE

Turbo Debugger recognizes packed BCD numbers and can display their values in the Watch and Variable windows. The debugger does not recognize unpacked BCD numbers. Use the `View:Dump` command to view the bytes of unpacked values.

Figure 11.1.
The packed BCD value
81,659,247 as stored in
memory.

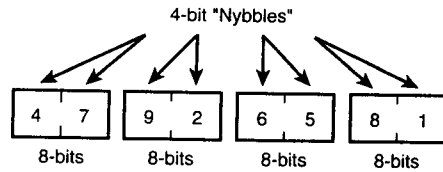
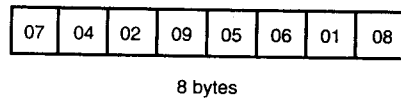

Figure 11.2.
The unpacked BCD value
81,659,247 as stored in
memory.



Unpacked BCD Instructions

Four 8086 instructions `aaa`, `aad`, `aam`, and `aas` convert unpacked BCD digits to and from binary values, making operations on BCD numbers easy to write. Let's take these one by one.

Use `aaa` (ASCII Adjust After Addition) after adding two single-digit BCD bytes with `add` or `adc`. The sum must be in `al`. If the sum is greater than `09`, then `ah` is incremented, and `al` is adjusted to be within the range 0–9. For example, to add the two digits `04` and `08`, you can write:

```

mov bl, 04h    ; First digit in bl
mov al, 08h    ; Second digit in al
add al, bl     ; Sum must be in al
xor ah, ah     ; Zero ah
aaa           ; Adjust to unpacked BCD

```

This adds the unpacked values `04` and `08`, placing the sum in `al`. Because the addition is done in binary, `al` in this example now equals `0Ch`. To convert this value back to unpacked BCD form, `xor` zeros `ah`, and `aaa` is executed. Because in this example the sum in `al` is greater than 9, `ah` is incremented, and `al` is adjusted. The result is `ax = 0102`—the answer (12) in unpacked BCD format.

A similar instruction `aas` (ASCII Adjust After Subtraction) adjusts the difference of two unpacked BCD digits after `sub` or `sbb`. If a borrow was required, then 1 is subtracted from `ah`, and `al` is adjusted to be within the range 0–9. For example, to subtract `08` from `0406`, you can write:

```

mov ax, 0406h  ; Assign first value to ax
mov bl, 08h    ; Assign second value to bl
sub al, bl     ; Subtract 0406h - 08H
aas           ; Adjust to unpacked BCD

```

The binary subtraction leaves `ax = 04feh`, which `aas` then converts to the unpacked BCD value `0308h`, or 38 decimal—the result of subtracting 46 – 8.

Two other instructions `aad` (ASCII Adjust Before Division) and `aam` (ASCII Adjust After Multiplication) convert unpacked BCD values to and from binary, which you might do before and after BCD multiplication and division. But don't be taken in by the suggestive mnemonics—you can use these instructions at other times, too. You don't have to follow `aad` with a division or precede `aam` with a multiplication.

To convert two unpacked BCD numbers in `ax` to binary, use `aad`. Because the largest such number that `ax` can hold is `0909h`, `aad` always zeros `ah` while setting `al` to the binary equivalent of the BCD digits. For example:

```
mov ax, 0406h    ; Assign unpacked BCD to ax
aad              ; Convert. ax = 002Eh (46 decimal)
```

The unpacked BCD value `0406h` in `ax` is converted to the binary equivalent value `002Eh` (46 decimal) by `aad`. To reverse the process, converting binary values to unpacked BCD, use `aam` as in this sample:

```
mov ax, 005Fh    ; Assign binary value to ax
aam              ; Convert. ax = 0905h (05F hexadecimal)
```

The binary value `005Fh` (95 decimal) in `ax` is converted to the unpacked BCD equivalent `0905h` by `aam`. The largest such value that `aam` can handle in `ax` is `0063h` (99 decimal).

Converting Unpacked BCD and ASCII

Because the upper 4 bits of an unpacked BCD byte always equal 0 (see Figure 11.2), converting unpacked BCDs to and from ASCII is easy. Recall that the ASCII digits 0-9 are encoded as the hexadecimal values `30h-39h`; therefore, to convert unpacked BCD digits to ASCII is a simple matter of setting the upper 4 bits to 3:

```
mov ax, 0307h    ; Assign unpacked BCD to ax
or  ax, 3030h    ; Convert to ASCII (ax = 03337h)
```

Oring `ax` with `3030h` sets the upper 4 bits in both `ah` and `al` to 3, changing `0307h` to `3337h`—the two ASCII encoded digits `33h` (3) and `37h` (7). Converting ASCII digits to unpacked BCD format is equally simple—just use `and` to strip the ASCII information from each digit:

```
mov ax, '81'     ; Assigns 03831h to ax
and ax, 0F0Fh    ; Convert to unpacked BCD (ax = 0801h)
```

After assigning the string '81' (equal to `03831h`) to `ax`, a logical AND with the mask `0F0Fh` sets the upper 4 bits of both `ah` and `al` to 0, thus converting the digits to unpacked BCD format.

NOTE

The order of digits in the previous two samples is not reversed as shown in Figure 11.2. When converting unpacked BCDs to and from ASCII, you have to pay attention to such details.

Packed BCD Instructions

Two “Decimal” instructions `daa` and `das` operate on packed BCD values, similar to the way the “ASCII” instructions `aaa` and `aas` work. Use `daa` after adding two packed BCD bytes containing two digits each as in:

```
xor ah, ah      ; Zero ah
mov al, 087h   ; Set al to packed BCD 87
mov bl, 035h   ; Set bl to packed BCD 35
add al, bl     ; Add al <- al + bl
daa           ; Convert. al = 22h, cf, ah = 1
```

The `xor` zeros `ah` for reasons explained later. The two packed BCD values `87h` and `35h` are assigned to `al` and `bl`. An `add` instruction adds the values, placing the binary sum in `al`, which then equals `0BCh`. Executing `daa` converts this binary value to packed BCD, setting `al` to `22h`. But the correct answer is 122 ($87 + 35$), not 22, and the code must be completed by checking the carry flag for a possible overflow:

```
jnc @@10      ; Skip increment if cf = 0
inc ah        ; Add 1 to ah
@@10:
```

Technically, if `daa` detects an overflow when the packed BCD result after addition is greater than 99 (the maximum BCD value that 1 byte can store), both `cf` and `af` flags are set to 1; otherwise, both flags are cleared. In practice, you can just check `cf` to detect this condition. In this example, `ah` is incremented, setting `ax` to the correct answer `0122h`. This is the reason that `ah` was zeroed earlier.

NOTE

After `daa`, if `af` = 1 and `cf` = 0, then the result in `al` is within the range `10h` to `99h`—in other words, a carry was generated out of the lower 4 bits of the answer—a fact of little practical value.

The complement to `daa` is `das`, which adjusts packed BCD values after subtraction by `sub` or `sbb`. Because subtraction can generate negative numbers, using `das` requires a little extra care. First, let’s look at a sample that produces a positive result:

```
mov al, 062h   ; Set al to packed BCD 62
mov bl, 036h   ; Set bl to packed BCD 36
sub al, bl     ; Subtract al <- al - bl
das           ; Convert. al = 026h
```

The packed BCD values `62h` and `36h` are assigned to `al` and `bl`. A `sub` instruction subtracts the values, depositing the binary difference (`02Ch`) in `al`. Executing `das` converts this binary value to packed BCD, changing `al` to `026h`—the correct answer in decimal for the subtraction $62 - 36$. After this, if `cf` equals 0, then no borrow was required; therefore, the answer in `al` can be used directly.

NOTE

Technically, both *cf* and *af* must equal 0 to indicate no borrow. If *cf* = 0 but *af* = 1, then a borrow was required by the lower digits. If you run the previous sample in Turbo Debugger, you'll see this happen. Subtracting 62 – 36 requires a borrow for the lower two digits (2 and 6). Normally, you can ignore this special condition and just inspect *cf* to see if a borrow was required for the full subtraction.

When a subtraction generates a negative result, the process becomes more complicated. You must check the carry flag to detect a borrow from the subtraction, indicating that the result in *a1* is a negative decimal complement, which can then be further manipulated to find the absolute value of the answer. An example helps clarify how to do this:

```
mov al, 036h ; Set a1 to packed BCD 36
mov bl, 062h ; Set b1 to packed BCD 62
sub al, bl   ; Subtract a1 <- a1 - b1
das         ; Convert. a1 = 074h
jnc @@10   ; Jump if no borrow
neg al     ; Negate al (in binary)
das       ; Convert to packed BCD
@@10:
```

As before, *a1* and *b1* are assigned the packed BCD values to be subtracted. A *sub* instruction subtracts *b1* from *a1*, which in this sample creates a negative (two's complement) binary result in *a1* equal to 0D4h. This value is converted to packed BCD format by *das*, changing *a1* to 74h. But this is not the correct answer—(36 – 62) = –26, not 74. A check of the carry flag by *jnc* detects this condition, indicating that *a1* is a decimal complement, converted to an absolute value by subtracting 100. (74 – 100 = –26, the correct answer.) The easiest (though perhaps not most obvious) way to find the decimal complement is to execute *neg*, which subtracts its operand value (*a1* in this case) from 0. Because this leaves the answer in *a1* in binary, another *das* again converts the result back to packed BCD format, setting *a1* at long last to the correct absolute value answer, 26.

A BCD Math Package

Performing math operations on *multiple-precision values*—those containing more bytes or words than can comfortably fit within registers and, therefore, requiring multiple operations to add, subtract, multiply, and divide—adds an additional level of difficulty to programming BCD procedures. To demonstrate some of the issues involved in writing such routines, and to give you a few useful procedures that you can use in your own code, Listing 11.1, BCD.ASM, contains six subroutines to add and subtract packed BCD values and to convert BCD numbers among packed, unpacked, and ASCIIZ string formats. There's also a procedure that copies a packed BCD 10-byte value to another BCD variable. Assemble and store the module in MTA.LIB with the commands:

```
tasm /zi bcd
tlib /E mta --bcd
```

As usual, ignore the warning that BCD is not in the library—it won't be until you install it the first time. If you make any changes to the programming, use these same commands to reassemble and install the new module. Instructions for using the BCD module follow the listing.

Listing 11.1. BCD.ASM.

```
1: %TITLE "Binary Coded Decimals (BCD) -- by Tom Swan"
2:
3:     IDEAL
4:
5:     MODEL    small
6:
7:
8: ;----- Equates
9:
10: ASCIIINull    EQU    0      ; ASCII end-of-string null character
11: PackedSize    EQU    10     ; Bytes in a packed BCD value
12: UnpackedSize  EQU    20     ; Bytes in an unpacked BCD value
13:
14: ;----- note: PackedSize must be even!
15:
16:
17:     UDATASEG
18:
19: TempUPBCD     DT        ?, ? ; Unpacked BCD word space (20 bytes)
20:
21:
22:     CODESEG
23:
24:     PUBLIC  BCDAAdd, BCDSUBTRACT, PackedToUnpacked
25:     PUBLIC  UnpackedToPacked, BCDToASCII, BCDCopy
26:
27: %NEWPAGE
28: ;-----
29: ; BCDAAdd                Add two packed BCD numbers
30: ;-----
31: ; Input:
32: ;     si = address of source BCD value (10 bytes)
33: ;     di = address of destination BCD value (10 bytes)
34: ; Output:
35: ;     destinationBCD <- destinationBCD + sourceBCD
36: ;     cf = 0 : No error
37: ;     cf = 1 : Overflow error occurred
38: ; Registers:
39: ;     none
40: ;-----
41: PROC    BCDAAdd
42:     push    ax                ; Save modified registers
43:     push    cx
44:     push    di
```

```

45:      push   si
46:
47:      cld                    ; Auto-increment si & di
48:      clc                    ; Clear carry for 1st adc
49:      mov    cx, PackedSize  ; Assign loop count to cx
50: @e10:
51:      lodsb                   ; Get two digits of source
52:      adc    al, [byte di]    ; Add two digits of dest + cf
53:      daa                    ; Adjust to packed BCD format
54:      stosb                   ; Store result in destination
55:      loop   @e10            ; Loop until done (cx = 0)
56:
57:      pop    si                ; Restore saved registers
58:      pop    di
59:      pop    cx
60:      pop    ax
61:      ret                    ; Return to caller
62: ENDP   BCDAdd
63: %NEWPAGE
64: ;-----
65: ; BCDSubtract      Subtract two packed BCD numbers
66: ;-----
67: ; Input:
68: ;     si = address of source BCD value (10 bytes)
69: ;     di = address of destination BCD value (10 bytes)
70: ; Output:
71: ;     destinationBCD <- destinationBCD - sourceBCD
72: ;     cf = 0 : No error
73: ;     cf = 1 : Underflow error occurred
74: ; Registers:
75: ;     none
76: ;-----
77: PROC   BCDSubtract
78:      push   ax                ; Save modified registers
79:      push   cx
80:      push   di
81:      push   si
82:
83:      cld                    ; Auto-increment si & di
84:      clc                    ; Clear carry for 1st sbb
85:      mov    cx, PackedSize  ; Assign loop count to cx
86: @e10:
87:      lodsb                   ; Get two digits of source
88:      sbb   [byte di], al     ; dest <- dest - source bytes
89:      mov   al, [byte di]    ; Load binary result into al
90:      das                    ; Adjust to packed BCD format
91:      stosb                   ; Store result in destination
92:      loop   @e10            ; Loop until done (cx = 0)
93:
94:      pop    si                ; Restore saved registers
95:      pop    di
96:      pop    cx
97:      pop    ax
98:      ret                    ; Return to caller
99: ENDP   BCDSubtract
100: %NEWPAGE

```

continues

Listing 11.1. continued

```

101: ;-----
102: ; PackedToUnpacked      Convert packed BCD to unpacked BCD
103: ;-----
104: ; Input:
105: ;     si = address of source packed BCD value (10 bytes)
106: ;     di = address of destination unpacked BCD value (20 bytes)
107: ; Output:
108: ;     destinationBCD <- unpacked( sourceBCD )
109: ; Registers:
110: ;     none
111: ;-----
112: PROC      PackedToUnpacked
113:     push  ax                ; Save modified registers
114:     push  cx
115:     push  di
116:     push  si
117:
118:     cld                    ; Auto-increment si & di
119:     mov   cx, PackedSize   ; Assign loop count to cx
120: @@10:
121:     lodsb                   ; Get two digits of source
122:     mov   ah, al           ; Copy digits from al to ah
123:     shr  ah, 1            ; Shift upper digit to
124:     shr  ah, 1            ; lower 4 bits of ah
125:     shr  ah, 1
126:     shr  ah, 1
127:     and  al, 0Fh          ; Mask upper digit from al
128:     stosw                   ; Store ax to destination
129:     loop @@10             ; Loop until done (cx = 0)
130:
131:     pop   si                ; Restore saved registers
132:     pop   di
133:     pop   cx
134:     pop   ax
135:     ret                    ; Return to caller
136: ENDP      PackedToUnpacked
137: %NEWPAGE
138: ;-----
139: ; UnpackedToPacked      Convert unpacked BCD to packed BCD
140: ;-----
141: ; Input:
142: ;     si = address of source unpacked BCD value (20 bytes)
143: ;     di = address of destination packed BCD value (10 bytes)
144: ; Output:
145: ;     destinationBCD <- packed( sourceBCD )
146: ; Registers:
147: ;-----
148: PROC      UnpackedToPacked
149:     push  ax                ; Save modified registers
150:     push  cx
151:     push  di
152:     push  si
153:
154:     cld                    ; Auto-increment si & di

```

```

155:      mov     cx, PackedSize      ; Assign loop count to cx
156: @@10:
157:      lodsw
158:      shl     ah, 1                ; Get two digits of source
159:      shl     ah, 1                ; Shift digit to
160:      shl     ah, 1                ; upper 4 bits of ah
161:      shl     ah, 1
162:      or      al, ah              ; Pack 2 digits into al
163:      stosb   ; Store al to destination
164:      loop   @@10                ; Loop until done (cx = 0)
165:
166:      pop     si                  ; Restore saved registers
167:      pop     di
168:      pop     cx
169:      pop     ax
170:      ret      ; Return to caller
171: ENDP   UnpackedToPacked
172: %NEWPAGE
173: ;-----
174: ; BCDToASCII          Convert packed BCD value to ASCII
175: ;-----
176: ; Input:
177: ;     si = address of source packed BCD value (10 bytes)
178: ;     di = address of destination ASCIIZ string (21 bytes)
179: ; Output:
180: ;     ASCIIZ <- ASCII( sourceBCD) + null character
181: ; Registers:
182: ;     none
183: ;-----
184: PROC   BCDToASCII
185:      push   ax                  ; Save modified registers
186:      push   cx
187:      push   di
188:      push   si
189:
190:      push   di                  ; Save destination address
191:      mov    di, offset TempUPBCD ; Use temporary work area
192:      call   PackedToUnpacked    ; Unpack source to temp
193:      pop    di                  ; Restore destination address
194:
195: ;----- Address last word of temporary work space
196:      mov    si, offset TempUPBCD + UnpackedSize - 2
197:
198:      mov    cx, PackedSize      ; Assign loop count to cx
199: @@10:
200:      std
201:      lodsw
202:      or     ax, 03030h          ; Get two digits into ax
203:      xchg  ah, al              ; Convert to ASCII
204:      cld
205:      stosw ; Swap characters
206:      loop  @@10                ; Auto-increment di
207:      mov   [byte di], ASCIIINull ; Store chars in destination
208:
209:      pop    si                  ; Loop until done (cx = 0)
210:      pop    di                  ; Store end-of-string marker
211:
212:      pop    si                  ; Restore saved registers
213:      pop    di

```

Listing 11.1. continued

```

211:      pop    cx
212:      pop    ax
213:      ret                                ; Return to caller
214: ENDP  BCDToASCII
215: %NEWPAGE
216: ;-----
217: ; BCDCopy          Copy a packed BCD value
218: ;-----
219: ; Input:
220: ;     si = address of source BCD value (10 bytes)
221: ;     di = address of destination BCD value (10 bytes)
222: ; Output:
223: ;     destinationBCD <- sourceBCD
224: ; Registers:
225: ;     none
226: ;-----
227: PROC   BCDCopy
228:      push   cx                        ; Save modified registers
229:      push   di
230:      push   si
231:
232:      cld                                ; Auto-increment si & di
233:      mov    cx, PackedSize/2          ; Assign loop count to cx
234:      rep    movsw                       ; Copy using word moves
235:
236:      pop    si                        ; Restore saved registers
237:      pop    di
238:      pop    cx
239:      ret                                ; Return to caller
240: ENDP  BCDCopy
241:
242:      END                                ; End of BCD module

```

Using the BCD Module

The six routines in the BCD module recognize the packed and unpacked BCD data formats described at the beginning of this chapter (See Figures 11.1 and 11.2.) Packed BCD values must be 10 bytes long and may contain up to 20 digits. Unpacked BCD values must be 20 bytes long and may also contain up to 20 digits. It's your responsibility to ensure that variables are large enough to hold the results of various operations. Also, because string instructions are used by all subroutines, segment registers *es* and *ds* must address the same data segment. To use the package in a program, declare the subroutines you need in *EXTRN* statements usually just after a *CODESEG* directive as in:

```

CODESEG
EXTRN  BCDAdd:proc, BCDSubtract:proc, PackedToUnpacked:proc
EXTRN  UnpackedToPacked:proc, BCDToASCII:proc, BCDCopy:proc

```

The code to `BCDAdd` demonstrates one way to add two multiple-precision values. The direction flag is cleared with `cld` (line 47) so that the later string instructions increment `si` and `di`, thus advancing the pointers through the bytes of the BCD values. Remember that packed BCDs are stored in reverse byte order (see Figure 11.1); therefore, the `lodsb` and `adc` instructions at lines 51–52 first add the least significant digits, then the next higher digits, and so on until the loop count in `cx` decrements to 0 at line 55, ending the repeated loop. The `daa` at line 53 converts the result of each addition to packed BCD before `stosb` stores this value in the destination.

Notice how the `c1c` at line 48 clears the carry flag. Because of this, the first `adc` performs an `add` (adding a 0 carry to the answer). This trick eliminates the need to use the `add` instruction to sum the low-order values, followed by subsequent `adc` instructions to add higher-order values with possible carries.

BCDSubtract (64–99)

`BCDSubtract` operates similarly to `BCDAdd`. In fact, only three instructions differ (compare lines 89–90 to lines 52–53). Assign the offset addresses to two packed BCD values to `si` and `di` and then call `BCDSubtract` to calculate the difference, storing the result in the variable addressed by `di`. If `cf = 1` after `BCDSubtract`, then underflow occurred and, as with unsigned binary subtractions, the value at `di` “wraps around.” In other words, subtracting BCD `03` from `01` produces `9999999999999999998` and sets `cf` to 1. Here’s an example:

```

DATASEG
v1      dt      81659247      ; BCD 81,659,247
v2      dt      74295618      ; BCD 74,295,618
CODESEG
mov     si, offset v2      ; Address v2 with si
mov     di, offset v1      ; Address v1 with di
call   BCDSubtract      ; Subtract v2 <- v2 - v1
jc     Exit              ; Exit on underflow

```

Take care to assign the offset addresses in the correct order, remembering that the value at `si` is subtracted *from* the value at `di`, which is also replaced with the answer. You might want to call `BCDCopy` to preserve the original value addressed by `di`.

The two instructions at lines 88–89 subtract packed BCD bytes in the correct order (destination-source) and then load the answer into `a1` for the subsequent conversion to packed BCD form with `das` at line 90. Other than these three instructions, the rest of the procedure operates as explained for `BCDAdd`.

PackedToUnpacked (101–136) UnpackedToPacked (138–171)

Call `PackedToUnpacked` to convert a packed BCD value to unpacked format. Register `si` must address a 10-byte packed BCD variable. Register `di` must address a 20-byte space to hold the result. The value at `si` is not changed. Make sure that at least 20 bytes are available at `di` to prevent `PackedToUnpacked` from overwriting other data or code in memory. The packed BCD value must be in the format created by `dt` as illustrated in Figure 11.1—individual digit pairs are stored in high-to-low order. `PackedToUnpacked` stores one BCD digit per byte (upper 4 bits cleared) in low-to-high order. (See Figure 11.2.)

Call `UnpackedToPacked` to reverse these steps, converting an unpacked BCD 20-byte value to a packed BCD 10-byte variable. Register `si` must address the unpacked 20-byte BCD value. Register `di` must address a 10-byte space to hold the result. The value at `si` is not changed. As with `PackedToUnpacked`, make sure that at least 10 bytes are available at `di` to prevent the procedure from overwriting other items in memory.

Both of these procedures use similar methods to load and convert values. Notice how both byte and word forms of string instructions (lines 121, 128, 157, and 163) are used along with the logical AND and OR and shift instructions to shuffle digits into the proper positions for the conversions. You should be able to follow these instructions by reading the comments, but, if you need a little help, run a test program in Turbo Debugger and watch the `ax` register as you pack and unpack various BCD variables.

BCDToASCII (173–214)

This routine converts a packed BCD value as created by `dt` to an ASCIIZ string, which must be at least 21 bytes long. Failure to observe this minimum length restriction could overwrite other values in memory. Along with the `StrWrite` routine from the `STRIO` package in Chapter 5, “Simple Data Structures,” you can use `BCDToASCII` to display (or print) BCD values. For example:

```

DATASEG
v1    dt      81659247      ; BCD 81,659,247
string db    40 dup (0)    ; At least 21 bytes!
CODESEG
mov    si, offset v1      ; Address v1 with si
mov    di, offset string  ; Address string with di
call   BCDToASCII        ; Convert BCD to ASCIIZ
call   StrWrite          ; Write string to output
call   NewLine           ; Start a new output line

```

This code writes 0000000000081659247 to the standard output file, usually the display. As you can see, the string is unformatted, and you may want to add commas and a decimal point, strip leading zeros, and perhaps attach a dollar sign, possibly using some of the `STRING` module's procedures described in Chapter 5.

The code at lines 190–207 may seem overly complex for what should be a simple conversion. The instructions are necessary (as you'll see if you work through them in Turbo Debugger) because of the format differences between packed and unpacked values and strings. The procedure calls `PackedToUnpacked` at line 192, first converting the packed BCD value to unpacked format. Then, after initializing `si` to address the end of the string (line 196), a loop at lines 199–206 converts digit pairs to ASCII (see line 202), swaps the digits with `xchg`, and stores the result in correct order into the string variable. A final `mov` at line 207 tags on a null terminator, required by the `ASCIIZ` string format.

BCDCopy (216–240)

Call `BCDCopy` to copy one packed BCD variable to another. Register `si` addresses the original value. Register `di` addresses the destination, which must be at least 10 bytes long. After `BCDCopy`, the value at `di` is replaced with the value from `si`. For example:

```

DATASEG
v1      dt      7295155      ; BCD 7,295,155
v2      dt      ?
CODESEG
mov     si, offset v1      ; Address v1 (source) with si
mov     di, offset v2      ; Address v2 (destination) with di
call    BCDCopy           ; Copy BCD at v1 to v2
call    BCDAAdd           ; Add v2 <- v2 + v1 (i.e., v1 * 2)

```

In this sample, `BCDCopy` copies the value at `v1` to the uninitialized value at `v2`. After this, `BCDAAdd` adds the two variables, setting `v2` to `v1` times 2.

Advanced Separate Assemblies

Turbo Assembler has three directives that can smooth some of the bumps associated with assembling large, multimodule programs. This section describes how to use the directives:

- `COMM`—Communal
- `GLOBAL`—Global Variables
- `INCLUDELIB`—Include Library Module

NOTE

Turbo Linker 2.0 and earlier versions do not support the `COMM` directive.

Using Communal Variables

The `COMM` directive defines *communal variables*, which are similar to uninitialized variables and can be declared in multiple modules. For example, suppose several modules use a 100-byte array of bytes plus an index variable. You can declare these variables in `COMM` directives this way:

```
DATASEG
COMM near index:Word
COMM near array:Byte:100
```

Multiple definitions can be separated by commas in a single `COMM` statement, but separate lines as shown here are easier to read. The first item after `COMM` is optional and can be either `near` or `far`, indicating whether this variable is addressable in the current data segment or in another segment. When using a simplified memory model, it's not necessary to specify `near` or `far`—Turbo Assembler will check all references to communals, issuing an error if you try to address a variable in the wrong segment. The second item is the name of the variable followed by a colon and size, which can be `byte`, `word`, `dword`, `fword`, `pword`, `qword`, or `tbyte`. You can also specify a structure name. After this comes an optional colon and count value (:100 in the second line of the example), telling the assembler how many bytes to allocate for this item. If you don't specify a count, Turbo Linker allocates space for only one element of the specified size.

The actual storage space for communal variables is not allocated until you link the modules. Variables of the same names declared in multiple modules are overlaid in the result. This way, instead of declaring variables `PUBLIC` in the defining modules and `EXTRN` in the using modules, you can simply define all variables communal in all modules and let Turbo Linker reduce all such multiple references to single variables.

The price you pay for this convenience is the inability to initialize communal variables. Like all uninitialized variables, communal variables have no specific values when the program runs. There's also no guarantee about where or in what order the variables will appear in memory—so don't assume that two communal variables will be in consecutive locations when the program runs. To avoid these restrictions and still enjoy the benefits of not having to use `PUBLIC` and `EXTRN`, Turbo Assembler has a similar but more flexible directive `GLOBAL`, described next.

Using Global Variables

The GLOBAL directive is similar to COMM but allows you to assign initial values to variables that multiple modules share. Using the same two variables described in the previous section, one module might declare and initialize array and index variables with the statements:

```
DATASEG
GLOBAL index:Word
GLOBAL array:Byte:100
;
index    dw    0
array    db    100 dup (1)
```

Inside the current data segment, two GLOBAL directives declare a word `index` and a byte array. The data types after the colon may be the same as for COMM. The optional count (100) after the array declaration tells the assembler how many bytes this variable occupies. You have to specify a count only if the allocation directives (`db`, `dw`, and the like) declare multiple values or use the `dup` operator; otherwise, the assembler has no way of knowing that `array` in this example is not a single byte. The actual two variables are declared and initialized as usual, creating an `index` initialized to 0 with `dw` and an array of 100 bytes each initialized to 1 with `db`.

To refer to these same variables in other modules, just repeat the GLOBAL directives. The actual variable allocations (using `dw` and `db`, for example) must appear in only one module. As these examples demonstrate, the variables are now accessible from all program modules without a single PUBLIC or EXTRN.

Including Global Variables

A good way to organize a large multimodule program is to keep global variables in a separate file and then include that file in all modules. This keeps the variables in one handy place and avoids nasty surprises and conflicts that can arise when using hundreds of PUBLIC and EXTRN directives. Also, in situations like this, you'll begin to appreciate the real power of the GLOBAL directive. A good approach is to declare your global variables in a text file, perhaps named GLOBAL.ASM:

```
; GLOBAL.ASM file
;
GLOBAL index:Word
GLOBAL array:Byte:100
;
; other globals
```

Then, in each module that needs to refer to one or more global variables, add this statement usually somewhere after a DATASEG directive:

```
; AMODULE.ASM (partial)
;
```

```

DATASEG
INCLUDE "GLOBAL.ASM"
;
; other local variables

```

You can still declare other local variables in this module—only the global variables are shared with other modules. The `INCLUDE` directive loads the global declarations from `GLOBAL.ASM`, making the definitions available to the module. In addition, you need an initialization module that actually declares the variables:

```

; INIT.ASM (partial)
DATASEG
INCLUDE "GLOBAL.ASM"
index dw 0
array db 100 dup (1)

```

`INIT.ASM` declares and initializes the variables. Again, `GLOBAL.ASM` is included, just as in other modules. (You can either assemble `INIT.ASM` just as you do other separate modules or include the text in your main program.) With `GLOBAL`, you avoid using `PUBLIC` and `EXTRN`, while you add the ability to store all global variables and initializations in one or two handy files. Also, you avoid the restriction of `COMM`, which does not allow initialization of variables.

Using the INCLUDELIB Directive

In most of the preceding chapters, instructions are given for adding module `.OBJ` files to the `MTA.LIB` library file. Turbo Linker commands then refer to this file to extract the modules containing procedures declared in `EXTRN` directives in a program's (or other module's) code segment. To simplify the link command, you can insert an `INCLUDELIB` directive, which tells the linker to look in a named library file for modules. For example, you can add this line somewhere near the beginning of the main program:

```
INCLUDE "MTA"
```

If you don't add a file-name extension, the linker assumes the name ends with `.LIB`. The file name may also have path information as in `"c:\library\MTA.LIB"`. You can now assemble and link the program with commands such as:

```
tasm myprog
tlink myprog
```

Because of the `INCLUDELIB` directive, the necessary modules are extracted from `MTA.LIB` automatically without referring to the library file explicitly in the `tlink` command. Put the `INCLUDELIB` directive only in the main module—don't use this directive to refer to the same library file in more than one module at a time.

NOTE

Even with an `INCLUDELIB` directive, you still have to use `EXTRN` directives to import procedures declared `PUBLIC` in library modules.

Processing Tables

As a general rule of thumb, if you can look up values in a table rather than calculate those same values with numeric expressions, your programs will gain speed. Usually, it takes only a couple of instructions to look up a value, while it takes several instructions to perform a calculation. If you can use the special 8086 table-processing instruction `xlat` (Translate From Table), you may be able to save even more time.

The `xlat` instruction requires `ds:bx` to address a table of bytes. An index value in `al` is added to this address, locating one of the bytes in the table. Executing `xlat` loads this byte into `al`, replacing the register's original value. In other words, the index value in `al` is *translated* to an associated byte from the table. A small example explains how this works. Assemble and link Listing 11.2, `TABLE.ASM`, with the commands:

```
tasm /zi table
tlink /v table
```

Listing 11.2. TABLE.ASM.

```
1: %TITLE "Table translation -- Copyright (c) 1989,1995 by Tom Swan"
2:
3:         IDEAL
4:
5:         MODEL    small
6:         STACK    256
7:
8:         DATASEG
9:
10: ;-----
11: ;indexes      0, 1, 2, 3, 4, 5, 6, 7, 8, 9
12: ;-----
13: btable db    0, 1, 4, 9, 16, 25, 36, 49, 64, 81
14:
15:         CODESEG
16:
17: Start:
18:         mov     ax,@data           ; Initialize DS to address
19:         mov     ds,ax             ; of data segment
20:
21:         mov     bx, offset btable  ; Address btable with ds:bx
22:         mov     cx, 9              ; Assign loop count to cx
23: @e10:
24:         mov     al, cl             ; Copy index value to al
```

```

25:      xlat                ; Translate from btable
26:      loop    @@10       ; Loop on cx
27:
28: Exit:
29:      mov     ax,04C00h   ; DOS function: Exit program
30:      int     21h        ; Call DOS. Terminate program
31:
32:      END     Start      ; End of program / entry point

```

How TABLE.ASM Works

Load the assemble TABLE program into Turbo Debugger with the command `td table` and press Alt-V-C to switch the CPU window. Press F5 to zoom the window to full screen and then follow these steps:

1. Press F7 twice, then once again to load `bx` with the offset address of the `btable` variable at line 13. Press F7 again to load `cx` with the loop count (9).
2. The cursor should be on the `mov` instruction. Press F7 to copy `c1` to `a1`. You should see the `a1` register (upper right of the screen) change to 09.
3. Press F7 to execute the `xlat` instruction, translating the value in `a1` to a value in the `btable` addressed by `ds:bx`. On the first time through the loop, this changes `a1` to 51h (81 decimal)—twice the original value in `a1`.
4. Press F7 repeatedly to execute all passes through the loop, setting `a1` to smaller and smaller index values, which are translated to other bytes from the `btable`.

This experiment demonstrates how `xlat` works, translating index values in `a1` to table bytes, although you could do the same job more easily by simply adding `a1` to itself. A more useful example follows.

Practical xlat Uses

One of the most common uses for `xlat` is to translate ASCII characters to other characters, perhaps in a terminal emulator program that needs to pass certain values to a remote system when you press a control key. The easy way to program this is to create a table of values, indexed by the original ASCII characters. As an example of how this works, Listing 11.3, BOXCHAR.ASM, translates keys Alt-1, Alt-2, ..., Alt-0 to ten extended ASCII characters commonly used on PCs to draw boxes. Assemble, link, and run the program with MTA.LIB on disk and the commands:

```

tasm boxchar
tlink boxchar,,, mta
boxchar

```

Press Alt and any digit key to display a box character. This illustrates how `xlat` can translate key codes to other ASCII values. Press F10 to end the demonstration.

Listing 11.3. BOXCHAR.ASM.

```

1: %TITLE "Box char demonstration -- by Tom Swan"
2:
3:         IDEAL
4:
5:         MODEL    small
6:         STACK    256
7:
8: cr      EQU      13      ; ASCII carriage return
9: lf      EQU      10      ; ASCII line feed
10: Fn10   EQU      100     ; GetCh value for F10
11: LowIndex EQU      152    ; GetCh value for Alt-1
12: HighIndex EQU      161   ; GetCh value for Alt-0
13:
14:         DATASEG
15:
16: message db      cr, lf, 'Sample Character Table Translation'
17:         db      cr, lf, 'Press Alt-1 to Alt-0 to display characters'
18:         db      cr, lf, 'Press F10 to end', cr, lf, lf, 0
19:
20: ctable  db      179, 180, 191, 192, 193, 194, 195, 196, 217, 218
21:
22:         CODESEG
23:
24:         EXTRN   StrWrite:proc, GetCh:proc
25:
26: Start:
27:         mov     ax, @data          ; Initialize DS to address
28:         mov     ds, ax            ; of data segment
29:         mov     es, ax            ; Make es = ds
30:
31:         mov     di, offset message ; Display instructions
32:         call    StrWrite
33: @@10:
34:         call    GetCh             ; Get key press
35:         jnz     @@10              ; Repeat if not function key
36:         cmp     al, Fn10          ; Check for F10
37:         je      Exit             ; Exit if F10 pressed
38:         cmp     al, LowIndex      ; Verify that al is within
39:         jb      @@10              ; range of LowIndex to
40:         cmp     al, HighIndex     ; HighIndex
41:         ja      @@10
42:         sub     al, LowIndex       ; Convert al to 0..n
43:         mov     bx, offset ctable ; Address ctable with ds:bx
44:         xlat
45:         mov     dl, al            ; Move new char in al to dl
46:         mov     ah, 2             ; DOS "display char" function
47:         int     21h              ; Call DOS to display char
48:         jmp     @@10             ; Repeat until done
49: Exit:
50:         mov     ax, 04C00h        ; DOS function: Exit program
51:         int     21h              ; Call DOS. Terminate program
52:
53:         END     Start           ; End of program / entry point

```

How BOXCHAR.ASM Works

The `table` variable at line 20 defines the extended ASCII characters for the keys Alt-1, Alt-2, ..., Alt-0. The code at lines 31–39 calls `getCh` in the `KEYBOARD` module (see Chapter 7, “Input and Output”) for a key press, returned in `al`. The other instructions in this section check for F10, which ends the program, and check that `al` is within the range of `LowIndex` to `HighIndex`. After this, line 42 subtracts the value of `LowIndex` from `al`, thus reducing the key value range from 151–161 to 0–10. Then lines 43 and 44 translate this adjusted index value to one of the `table` values, displaying this character with a call to DOS function 2 (lines 45–47).

Using `xlat` with Multiple-Dimension Tables

On occasion, `xlat` comes in handy for translating values in `al` representing the column number in two-dimensional matrix. Along with the `lea` (Load Effective Address) instruction, working with such complex arrays is not as difficult in assembly language as you may imagine. For example, suppose you have the following 4-row by 8-column matrix:

```

DATASEG
matrix db  00Fh, 04Bh, 087h, 0C3h, 00Fh, 04Bh, 01Eh, 05Ah
        db  096h, 0D2h, 01Eh, 05Ah, 02Dh, 069h, 0A5h, 0E1h
        db  02Dh, 069h, 03Ch, 078h, 0B4h, 0F0h, 03Ch, 078h
        db  09Dh, 0D2h, 04Fh, 067h, 003h, 079h, 099h, 000h

```

Next, suppose the program assigns a column number to `al` in the range 0–7 and a row number to `si` in the range 0–3. To load the byte at `matrix[row, column]` requires only a few instructions:

```

CODESEG
mov     al, 4           ; Load column number into al
mov     si, 2          ; Load row number into si
mov     cl, 3          ; Load shift count into cl
shl    si, cl          ; si ← si * 8
lea    bx, [matrix + si] ; ds:bx addresses table row
xlat                   ; al ← table[row, column]

```

Here, `al` equals 4 and `si` equals 2, the row and column index numbers. The third `mov` and `shl` instructions multiply the row number in `si` by the number of bytes in one row—8 in this example. Then `lea` loads `bx` with the offset address of this row. After loading `bx`, an `xlat` instruction translates the column index in `al` to the byte at the indexed column in this row of the table. The `lea` instruction has the same effect as the two instructions:

```

mov     bx, offset matrix
add     bx, si

```

Instead of doing this, always use `lea`—it’s faster than computing a complex address-reference manually by addition. You can use any of the addressing modes discussed in Chapter 5 as the parameter to `lea`. You can also assign the result to any general-purpose register, although `bx` is commonly used with the instruction.

Other xlat Forms

The `xlat` instruction allows a few variations. You can supply a table variable as a parameter to `xlat`, letting Turbo Assembler verify that the variable is addressable by `ds:bx`, which you still must initialize. For example:

```
mov    bx, offset atable    ; Address atable with bx
mov    al, [index]         ; Load index value into al
xlat   [atable]            ; Translate al from table (ds:bx)
```

With a parameter to `xlat`, Turbo Assembler verifies that `atable` is in the segment addressed by `ds`. You can use a similar construction with a segment override to reference a table located in a segment addressed by `es`:

```
mov    bx, offset atable    ; Address atable with bx
mov    al, [index]         ; Load index value into al
xlat   [es:atable]         ; Translate al from table (es:bx)
```

The segment override changes `xlat`'s usual segment base register `ds` to `es`. You must specify a parameter in this case, but if you don't want to refer to the variable by name, you can also use `bx` this way:

```
mov    bx, offset atable    ; Address atable with bx
mov    al, [index]         ; Load index value into al
xlat   [es:bx]             ; Translate al from table (es:bx)
```

In addition, you can use the shorthand mnemonic `xlatb` in exactly the same way as `xlat` without a parameter:

```
mov    bx, offset atable    ; Address atable with bx
mov    al, [index]         ; Load index value into al
xlatb                                     ; Translate al from table (ds:bx)
```

To be honest, it's not clear to me why the `xlatb` mnemonic even exists—you can just use `xlat` without a parameter to perform the identical task. The only significant difference between the two names is that the `xlatb` mnemonic may never have a parameter, while `xlat` may be used with or without a parameter.

Declaring Segments the Hard Way

Most of the programs in this book take advantage of Turbo Assembler's simplified memory models, using directives such as `CODESEG` and `DATASEG` to define the start of the program's code and data segments. For most purposes, this gives you all the control you need to separate code from data and to organize your program sensibly. On the rare occasions that you need more control over the names and sizes of segments, however, simplified memory models may be inadequate. At such times, you must declare segments "the hard way," using the `SEGMENT`, `ASSUME`, and `GROUP` directives.

The SEGMENT Directive

SEGMENT tells Turbo Assembler to collect whatever follows into one memory segment, which can store data, code, or the stack. A program can declare many segments, assigning various attributes and names that cause the data or code to be combined according to all sorts of rules and regulations. The full syntax for SEGMENT is:

```
SEGMENT name [align] [combine] [use] ['class'] [access]
```

The segment *name* is required and can be any identifier you like—similar to any other program label. The other four elements are optional (as indicated by the brackets). Each operand has its own rules and formats, explained in the following notes:

- *name*—Any identifier such as MYDATA or SEGA45X. You can repeat the same name in multiple SEGMENT declarations, even in multiple program modules. Turbo Assembler combines all equally named segments into one large segment. You can locate this segment in memory by assigning the offset address of *name* to a segment register. You need to specify the following attributes only the first time you declare a segment.
- *align*—Specifies a boundary restriction for the start of the segment. Table 11.1 lists the various symbols that you can use for *align*. During assembly, if the current location at the start of the segment does not satisfy the specified rule for this align type, the assembler's location counter is advanced by an appropriate amount, forcing the segment to begin farther down (at a higher address) and possibly wasting a few bytes. If you don't specify an alignment, segments are aligned to the next highest 16-byte paragraph (PARA alignment).
- *combine*—Specifies rules for organizing segments and for combining multiple segments in memory. Table 11.2 lists the symbols that you can use for *combine*. The default *combine* rule is PRIVATE.
- *use*—Applies only to 80386, or later-model processors, in programs using the P386, P386N, P486, P586, and similar directives that enable special processor instructions and extended registers not available on the 8088 and 8086 CPUs. Table 11.3 lists the symbols that you can use for *use*. Most programs do not need this operand.
- *'class'*—Serves as a kind of category specification. All segments with identical *'class'* names—even those with different *name* names—are physically loaded together in memory when the program runs.
- *access*—For use only in protected-mode programs that are linked to a DOS extender using the Phar Lap linker. (Turbo Linker does not support this feature.) Assemble programs with the /op option. Specifies to the linker the types of access restrictions to assign to a protected mode segment, according to the various types listed in Table 11.4.

Table 11.1. SEGMENT align Symbols.

<i>Symbol</i>	<i>Align Segment to the Next...</i>
Byte	Byte address (current location)
Word	Word address (LSD of address = 0)
Dword	Doubleword address (2 LSDs of address = 0)
Para	16-byte paragraph (4 LSDs of address = 0)
Page	256-byte page (8 LSDs of address = 0)
MemPage	Start segment on next memory page (4K boundary)

Table 11.2. SEGMENT combine Symbols.

<i>Symbol</i>	<i>Meaning</i>
<i>At expression</i>	Locate segment at the address specified by <i>expression</i> , which must be an absolute paragraph address such as 0F00h or 0040h. Use this option to refer to data already in memory such as ROM BIOS variables.
Common	Segments of the same name are overlaid. The size of the segment equals the size of the largest of all segments. Use this option to refer to common variables among multiple modules.
Memory	Identical to <i>Public</i> . Causes segments of the same names to be joined one after the other.
Private	The default setting. Causes segments of the same name to be treated as separate segments. You must initialize a segment register to address each segment before you can access variables in the segment.
Public	Causes all segments of the same name to be joined one after the other in memory, in the order declared in the program. The result is one large segment containing all data or code in all segments. You need to initialize a segment register to address only the first of all combined segments to access variables declared in the segments.
Stack	Use this option only to declare stack space, usually in the main program module. All .EXE programs must declare a stack segment. The linker inserts information in the .EXE file that DOS uses to load registers <i>ss</i> and <i>sp</i> automatically at runtime.

<i>Symbol</i>	<i>Meaning</i>
	You don't have to load these registers in your program. Multiple segments of the same name with the <i>combine</i> -type STACK are joined one after the other to form one large stack segment. This allows separate modules to declare as much space as needed for the stack. (Remember to add extra room for DOS, BIOS, and interrupt handlers.)
UnInit	Forces TASM to display a warning that data is written to an uninitialized segment. You might use this feature to warn users that a segment in a module requires initialization before use because the segment is allocated memory at runtime.
Virtual	Declares a common area that must be inside another segment. Typically used for collecting static data (or initialized variables) from multiple modules into a common space inside another segment. The virtual segment has the same attributes as the segment in which it is declared.

Table 11.3. SEGMENT use Symbols.

<i>Symbol</i>	<i>Meaning</i>
Use16	The default setting. Enables 16-bit segment displacement (offset) addressing and limits segment size to 64K.
Use32	Enables 32-bit segment displacement (offset) addressing and allows a maximum segment size of 4GB (gigabytes or billions of bytes).

Table 11.4. SEGMENT access Symbols.

<i>Symbol</i>	<i>Meaning</i>
ExecOnly	Segment may contain only executable code (no data)
ExecRead	Segment may contain executable code and read-only data
ReadOnly	Segment may contain only read-only data (no code)
ReadWrite	Segment may contain variable data (no code)

Using SEGMENT

A few examples will help explain how to set up segments in your own programs. Suppose you need three word variables in a data segment. You can declare them this way:

```
SEGMENT Dseg Para Public 'DATA'
v1      dw      0
v2      dw      1
v3      dw      2
ENDS    Dseg
```

The `ENDS` directive marks the end of the segment and must be included. You may add the same name `Dseg` here after `ENDS` or leave the space to the right blank. The segment is aligned to the next highest 16-byte paragraph in memory (`Para`) and, because of the `Public combine` type, is added to all other segments that are either named `Dseg` or that have the same 'class' name 'DATA'. To find the variables in this segment, you must initialize an appropriate segment register, usually `ds`. For example, to load `dx` with the value of variable `v2` requires these steps.

```
mov     ax, Dseg
mov     ds, ax
ASSUME ds:Dseg
mov     dx, [v2]
```

We'll get to `ASSUME` in a moment, but, for now, be aware that you must initialize a segment register to refer to variables in segments. In most cases, you can do this by assigning the value of the segment name—`Dseg` in this example. The problem is: These instructions are floating in space—they too must go in a segment. A typical code segment for a main program module might be:

```
SEGMENT Cseg Para Public 'CODE'
Start:
        mov     ax, Dseg           ; Assign segment address
        mov     ds, ax           ; to ds
        mov     es, ax           ; and to es
ASSUME  ds:Dseg, es:Dseg
;
; other instructions go here
;
ENDS    Cseg                     ; End of code segment
END     Start                    ; End of text
```

The code segment named `Cseg` is aligned to the next highest paragraph boundary, and the segment is combined with other `Csegs` in other modules or with segments of different names but with 'CODE' class designations. Notice how `END` specifies a start address, which the linker uses to insert information in the `.EXE` file for DOS to load the code segment (or segments) properly into memory, initialize `cs`, and jump to the first program instruction.

In addition to code and data segments, a `STACK` segment is required, or Turbo Linker will warn you that the program has no stack—a serious error unless the program is of the `.COM` variety. A typical stack segment is:

```

SEGMENT Sseg Word Stack 'STACK'
theStack      db      128 dup ('**Stack*')
ENDS

```

Because of the *combine* type stack, the `ss:sp` registers are automatically initialized to stack space, which is aligned to the next highest word address. The class name 'STACK' causes multiple stack segments of the same class to be combined, just as for other segments. Don't confuse these two items, which are usually spelled the same; only the *combine* type tells the linker that this is a stack segment. The stack space is allocated in this sample by a `db` directive, storing 128 copies of the string '**Stack*' in 1,024 bytes. During debugging, this makes finding the stack in memory easy—just hunt for the '**Stack*' strings. Also, after the program is finished, you can examine the declared stack and see how much stack space was used by looking for where the strings are obliterated. (Remember to add extra room for interrupt handlers—never pare your stack space down to the bare minimum.)

NOTE

One problem with this method is that stack data is stored in the .EXE code file on disk. In the finished version, you may want to convert your stack to a simplified memory model `STACK` directive or declare uninitialized stack space using the question mark operator (?) instead of literal strings. This will reduce the code-file size.

These three elements— data, code, and stack segments—are usually the minimum requirements in a program that declares stacks “the hard way.” Before using these ideas to write a full program, you also need to understand what `ASSUME` does.

The ASSUME Directive

To understand the `ASSUME` directive, think of your program as existing in two time dimensions. The first dimension is *assembly time*—the actions that occur when Turbo Assembler assembles the program text. The second dimension is *run time*—the actions that occur when `COMMAND.COM` loads your program into memory and executes the first instruction.

The `ASSUME` directive belongs strictly to the assembly time dimension—it has no effect on the program at run time. Use `ASSUME` to tell Turbo Assembler that segment registers such and such address segments so and so. For example, given the previous data-segment declaration for `Dseg`, to initialize the `es` register to address the segment in memory, you can write:

```

mov     ax, Dseg           ; Assign address of Dseg
mov     es, ax            ; to es via ax
ASSUME es:Dseg           ; Tell Turbo assembler where es points

```

At run time, the two `mov` instructions load `es` with the address of the `Dseg` data segment. At assembly time, the `ASSUME` directive tells Turbo Assembler where `es` currently points. The reason both steps are necessary is that Turbo Assembler assembles but doesn't "understand" assembly language code; therefore, you must tell the assembler to where `es` points, even though the previous instructions loaded `es` to that very same segment. `ASSUME` takes the general form:

```
ASSUME segReg:segName\NOTHING, ..., segReg:segName\NOTHING
```

The *segReg* may be `cs`, `ds`, `es`, or `ss`. 80386 and later-model programs can also specify the `fs` and `gs` registers, which are not available on the 8086 and 80286. The *segName* must refer to the name of the segment as declared in a `SEGMENT` directive. (As you'll see in a moment, *segName* can also refer to a segment group.) Instead of a *segName*, you can use the word `NOTHING`, which tells the assembler that the specified register addresses no specific segment at the moment.

By using `ASSUME`, you give Turbo Assembler the capability to perform two actions:

- Verify addressability of variables in data segments.
- Add segment overrides automatically as needed.

The second of these advantages is most important. By using `ASSUME`, Turbo Assembler can insert an `es:` segment override instruction. For example, suppose the previous `Dseg` segment is addressed only by `es`. This instruction:

```
ASSUME es:Dseg
mov    dx, [v1]
```

is actually assembled as:

```
mov    dx, [es:v1]
```

You can still specify the segment override, but you don't have to. `ASSUME` lets Turbo Assembler decide whether an override is needed. This is particularly handy when using string instructions and when referring to multiple segments with both `ds` and `es`. By using `ASSUME` after every assignment to a segment register, you ensure that Turbo Assembler will do everything possible to verify that memory references at least make sense and that variables are actually in the segments addressed by segment registers.

You can also specify multiple assumptions separated by commas. For example, using the segment declarations from the previous discussion for `SEGMENT`, a typical `ASSUME` directive might be:

```
ASSUME cs:Cseg, ds:Dseg, es:NOTHING, ss:Sseg
```

The GROUP Directive

Now that you have the tools you need to declare segments the hard way, you'll probably want to use a `GROUP` directive to simplify references to multiple segments. `GROUP` has the form:

GROUP *name segName [, ..., segName]*

The *name* and **GROUP** elements are reversed when assembling in MASM mode. The *name* can be any unused identifier such as `dggroup` or `stacksegs`. After the *name* comes one or more *segName*, which must be the names used in other **SEGMENT** declarations.

NOTE

The **GROUP** *segName* can also be an expression beginning with **SEG** as in **GROUP** `newgroup SEG myLabel`, although this use is rare. Usually, it's better to define named segments with **SEGMENT** and use the names in a **GROUP** directive.

Use **GROUP** when you have multiple segments of different names that you want to address with a single segment register. The segments may not have the same class names. In fact, if both the segment and class names are different, a **GROUP** directive is the only way to ensure that multiple segments are combined in memory. For example, if three modules declare data segments named `Dseg`, `LocalSeg`, and `OtherSeg`, you could use this **GROUP** directive:

```
GROUP DataGroup Dseg, LocalSeg, OtherSeg
```

Despite whether these segments are of the same class, they will be joined into one large segment in memory. You can now refer to all variables in the three segments by initializing `ds` (or `es`) and telling Turbo Assembler where `ds` now points:

```
mov ax, DataGroup ; Assign address of DataGroup
mov ds, ax ; to ds via ax
ASSUME ds:DataGroup ; Tell Turbo Assembler where ds points
```

Instead of loading `ds` with the offset of an individual segment, you now can load the offset to the group name, in this case `DataGroup`. The same group name is also used in an **ASSUME** directive, telling Turbo Assembler to where `ds` points.

After grouping multiple segments this way, offsets to individual variables in all joined segments are automatically computed. As long as the `ds` or `es` segment registers address the group name, you can be confident that all your variables are directly addressable. The only restriction is that all grouped segments can occupy no more than 64K.

Using Segments in Programs

When not using simplified memory models, declaring segments requires careful planning. Most of the time, a simplified model will do the job, but there is one little-known restriction on all such models. In your Turbo Assembler Reference Guide, in the discussion of the `.MODEL` directive (in Ideal mode, it is spelled `MODEL` with no period), several tables list the segment

names used by various simplified models. For reference, Table 11.4 lists these names for the small memory model, but showing the Ideal-mode directives used to declare each segment type.

NOTE

Most of the other memory models use names that are similar to those in Table 11.4. If you need to know what these names are, refer to the Turbo Assembler Reference Guide or assemble a program with the command `tasm /1 filename`. You'll find the segment names near the end of the .LST listing file.

Table 11.5 reveals a disturbing feature of simplified memory models. The data, uninitialized data, constant, and stack segments are combined under the group name DGROUP. This means that the *total* size of these segments is limited to 64K! In other words, the more stack space you declare, the less room you have for data. This is not true just for the small memory model. *All* simplified memory models group the stack and data segments together in DGROUP.

Table 11.5. Simplified Small Memory Model Segments.

<i>Directive*</i>	<i>Name</i>	<i>Align</i>	<i>Combine</i>	<i>Class</i>	<i>Group</i>
CODESEG	_TEXT	Word	Public	'CODE'	
FARDATA	FAR_DATA	Para	Private	'FAR_DATA'	
UFARDATA	FAR_BSS	Para	Private	'FAR_BSS'	
DATASEG	_DATA	Word	Public	'DATA'	DGROUP
CONST	CONST	Word	Public	'CONST'	DGROUP
UDATASEG	_BSS	Word	Public	'BSS'	DGROUP
STACK	STACK	Para	Stack	'STACK'	DGROUP

*Note: Ideal mode only.

By declaring your own segments, you can eliminate this restriction, as demonstrated in Listing 11.4, HARDSHEL.ASM—a “hard-way” version of the EXESHELL.ASM program from Chapter 2, “First Steps.” Use HARDSHEL.ASM as a template for your own programs when you want full control over segments. The shell allows space for two 64K data segments, one 64K stack segment, and a 64K code segment for a total potential program size of about 256K. To assemble the shell (which doesn't do anything, although it does run) and to print copies of the listing and map files, enter the commands:

```
tasm /l hardshel
tlink hardshel
type hardshel.lst >prn
type hardshel.map >prn
```

Listing 11.4. HARDSHEL.ASM.

```
1: %TITLE ".EXE shell; nonsimple segments -- Copyright (c) 1989,1995 by Tom Swan"
2:
3:     IDEAL
4:
5: ;----- Insert EQU and = equates here
6:
7:
8: SEGMENT SSeg Para Stack 'STACK'
9:
10: ;     db     1024 dup ('**Stack*') ; 8K debugging stack
11:     db     8192 dup (?) ; 8K uninitialized stack
12:
13: ENDS   SSeg
14:
15:
16: SEGMENT DSeg Word Public 'DATA'
17:
18: exCode      DB      0
19:
20: ;----- Declare other variables with DB, DW, etc. here
21:
22: ;----- Specify any EXTRN variables here
23:
24: ENDS   DSeg
25:
26:
27: SEGMENT ESeg Word Public 'EDATA'
28:
29: ;----- Alternate (far) data segment
30:
31: ENDS   ESeg
32:
33:
34: SEGMENT CSeg Word Public 'CODE'
35:
36: ;----- Specify any EXTRN procedures here
37:
38: Start:
39:     ASSUME ds:DSeg
40:     mov     ax, DSeg ; Initialize DS to address
41:     mov     ds, ax ; of data segment
42:     ASSUME es:ESeg
43:     mov     ax, ESeg ; Initialize ES to address
44:     mov     es, ax ; of extra data segment
45:
46: ;----- Insert program, subroutine calls, etc., here
47:
48: Exit:
```

continues

Listing 11.4. continued

```

49:      mov     ah, 04Ch           ; DOS function: Exit program
50:      mov     al, [exCode]      ; Return exit code value
51:      int     21h              ; Call DOS. Terminate program
52:
53: ENDS   CSeg                   ; End of Code segment
54:
55:      END     Start            ; End of program / entry point

```

Using HARDSHEL.ASM

A few notes will help you to use the HARDSHEL.ASM template. Line 10 is commented out. Remove the semicolon and turn line 11 into a comment to add 8K of ****Stack*** strings to the code file. When debugging, you can then examine the stack memory to see how much stack space the program actually uses.

Two segments `Dseg` and `Eseg` are declared at lines 16–31. These segments are not grouped together, although they could be if you want. (Of course, grouping multiple data segments also limits the total size of the combined segments to 64K.) Examine how the code at lines 39–44 initializes the `es` and `ds` segment registers to address the two separate segments.

NOTE

Most of the modules in this book assume that `es` and `ds` address the *same* data segment. When using HARDSHEL.ASM, you may have to modify these modules or temporarily reassign `es` to `ds` before calling module subroutines.

The code segment at lines 34–53 may contain up to 64K. If you need more space than this, you can declare additional code segments and make far subroutine calls to routines in these modules. If you do this, be sure to end the subroutines with `retf` not `ret`.

Where It's At

Table 11.2 lists the *combine* types that you can use in a `SEGMENT` directive. One of these types is `At`, which locates a segment at a specific address in memory. Such a segment is a *phantom*—a means to overlay variables declared in the program but already existing in memory as the result of other processes. This technique is especially useful for referring to variables that belong to DOS and the ROM BIOS. Obviously, such variables are not created by your own code but are initialized when you switch on the computer's power. There are two ways

to locate BIOS data. You can simply equate a symbol to an address in memory and read or write values to that address. (Consult a hardware technical reference for these addresses.) For improved clarity, however, which can help to avoid bugs caused by writing to the wrong places, it's a good idea to declare an `At` segment, as demonstrated by Listing 11.5, `COLDBOOT.ASM`. Assemble and link the program with the commands:

```
tasm coldboot
tlink coldboot
```

NOTE

Running `COLDBOOT` reboots your system, erasing any data in memory. Don't run the program unless that's what you want to do.

Listing 11.5. COLDBOOT.ASM.

```
1: %TITLE "Perform Warm or Cold Reboot -- by Tom Swan"
2:
3:     IDEAL
4:     MODEL    small
5:     STACK    256
6:
7: WarmBoot    EQU    1234h        ; Skips power-on system tests (POST)
8: ColdBoot    EQU    1234d        ; Other value may work
9:
10: BIOSDataLoc EQU    0040h        ; Segment address of BIOS data
11: ResetFlagLoc EQU    0072h        ; Offset to ResetFlag in BIOS data
12:
13:
14: ;----- Tell assembler where the ResetFlag word is located
15:
16: SEGMENT BIOSData at BIOSDataLoc
17:     ORG     ResetFlagLoc
18: LABEL   ResetFlag Word
19: ENDS
20:
21:     CODESEG
22:
23: Start:
24:     mov     ax, BIOSDataLoc      ; Address BIOSData segment
25:     mov     ds,ax                ; with ds
26:
27: ASSUME DS:BIOSData
28:
29:     mov     [ResetFlag],ColdBoot ; Set ResetFlag
30:
31:     END     Start                ; End of program / entry point
```

How COLDBOOT.ASM Works

The COLDBOOT program declares one “hard-way” segment, even though it also uses a simplified memory model. There’s nothing wrong with this—you can combine memory models and custom segments at will. This program declares one segment at the absolute address 0040h, which happens to be the start of the ROM BIOS data segment:

```
SEGMENT BIOSData at BIOSDataLoc
```

When the program runs, this segment is not actually loaded into memory; therefore, you can’t insert initialized variables into BIOSData. That would be a bad idea anyway—you’d be changing values that belong to the ROM BIOS. Usually, you’ll refer to variables that already exist, as demonstrated by lines 16–19. An `ORG` directive sets the origin to 0072h (symbolically named `ResetFlagLoc`), which represents the address of the system reset flag. The `LABEL` directive assigns a word label `ResetFlag` to this address so that later instructions have a way to refer to the data at this spot. The reason for using `ORG` is to avoid having to insert other variable declarations at lower addresses, which the program doesn’t need. There’s no reason to insert declarations for the entire BIOS data segment just to refer to a single variable.

With these details out of the way, lines 24–27 perform the crucial steps of loading `ds` with the address of BIOSData and using an `ASSUME` directive to tell Turbo Assembler where `ds` now points. After this, a `mov` assigns to `ResetFlag` the value of `ColDbBoot`, declared at line 8.

On some PCs, merely assigning that value to the system reset flag reboots the computer. On other PCs, you need to execute a jump to address F000:0000, at which a `jmp` instruction jumps to the ROM BIOS boot subroutine. On still other systems, you can execute `int 19h` to reboot. Unfortunately, it’s difficult to determine which of these various reboot methods will work on a given machine. COLDBOOT.ASM works on my system (a Toshiba T4400C laptop), but it may not work on yours.

NOTE

Exit Microsoft Windows and close any programs before running COLDBOOT.

Line 7 shows the value to assign to `ResetFlag` if you want to perform a warm boot—the same effect as pressing Ctrl-Alt-Delete. Using this value in place of `ColDbBoot` at line 29 still restarts my system but bypasses memory and other hardware tests, thus saving a little time.

Far Data Segments

When you need extra data space but you still want to use simplified memory models, you can use the `FARDATA` directive to create as many additional data segments as you need. There’s only one rule to remember—it’s up to you to initialize segment registers to access data in far

segments. Other than this minor complication, using far data segments is easy. For example, suppose you want to put all your program strings in a separate segment, thus leaving room in the default data segment for other variables. First, declare the segment with a `FARDATA` directive:

```
FARDATA
s1      db      'Welcome to TurboCalc', 0
s2      db      'Copyright 1999 by PC Universe', 0
s3      db      'Support hot line: 800-555-1212', 0
```

That's all you have to do to create a far data segment. Because such segments are not included in `DGROUP` (see Table 11.4), they are not combined with other segments. Consequently, to access variables in a far data segment, you must initialize one or more segment registers in your program code. For example, if you want to display the strings in this sample using routines in the `STRIO` module, you'll have to initialize both `es` and `ds` with:

```
CODESEG
mov     ax, @farData      ; Load address of far data segment
mov     ds, ax            ; Assign to ds
mov     es, ax            ; Assign also to es
ASSUME ds:@farData, es:@farData ; Tell Turbo Assembler!
```

First, `es` and `ds` are initialized to the address of the far data segment, using the predefined `@farData` symbol. The required `ASSUME` directive tells Turbo Assembler about this change to `ds`. You can then import routines in other modules such as `STRIO` and display strings with code such as:

```
EXTRN  StrWrite:proc, NewLine:proc
mov     di, offset s1
call    StrWrite
call    NewLine
```

To again restore `es` and `ds` to the default data segment, execute the usual instructions:

```
mov     ax, @data        ; Initialize ds to address
mov     ds, ax           ; of data segment
mov     es, ax           ; Make es = ds
ASSUME ds:@data, es:@data ; Tell Turbo Assembler
```

Don't forget the `ASSUME` directive. Remember, it's a good idea (and in this case required) always to tell Turbo Assembler about your assignments to segment registers. Another possibility is to push and pop segment registers to switch temporarily to a far data segment. For instance, suppose you want to load `dx` with a variable `v1` allocated in a `FARDATA` segment:

```
FARDATA
v1      dw      99      ; Variable in far data segment
CODESEG
push    ds              ; Save current ds on stack
mov     ax, @farData    ; Assign address of far data
mov     ds, ax          ; segment to ds
ASSUME ds:@farData     ; Tell Turbo Assembler where ds points
mov     dx, [v1]        ; Load value from far segment into dx
pop     ds              ; Restore original data segment register
ASSUME ds:@data        ; Tell Turbo Assembler where ds points
```

Again, `ASSUME` directives keep Turbo Assembler informed about the changes to `ds`. Don't forget the `ASSUME` after the `pop ds` instruction. Even though this restores `ds` to its original value, this action occurs at a runtime. You still have to tell Turbo Assembler what's going on during assembly time.

Multiple Far Data Segments

Normally, if you insert multiple `FARDATA` directives in various modules, all far data segments are combined into one segment up to 64K long. By adding an optional name to the directives, you can declare as many separate far data segments as you need. Let's assume you need two such segments. Here's how you might begin:

```
FARDATA FarOut
v1      dw      1
v2      dw      2

FARDATA FartherOut
v3      dw      3
v4      dw      4
```

The program now has two distinct far data segments `FarOut` and `FartherOut`. Each of these segments can be as large as 64K, increasing the program's total data space to 192K (including the default data segment less stack space and other items in `DGROUP`). The unique `FARDATA` names prevent the segments from being combined.

NOTE

If you repeat the same names after multiple `FARDATA` directives, the segments are combined as though the optional names did not exist.

To locate your data in various far data segments, load a segment register with the name you assigned to `FARDATA`. Use an `ASSUME` directive to tell Turbo Assembler where the segment registers point. For example, suppose you want to load `cx` with the value of `v1` (in the `FarOut` segment) and `dx` with the value of `v3` (in the `FartherOut` segment).

```
mov     ax, FarOut      ; Initialize ds to
mov     ds, ax          ; address FarOut segment
ASSUME ds:FarOut       ; Tell Turbo Assembler
mov     ax, FartherOut ; Initialize es to
mov     es, ax          ; address FartherOut segment
ASSUME es:FartherOut   ; Tell Turbo Assembler
mov     cx, [v1]        ; Load FarOut's v1 into cx
mov     dx, [v3]        ; Load FartherOut's v3 into dx
```

Because the `ASSUME` directives always keep Turbo Assembler informed about where `ds` and `es` point, the final two `mov` instructions can simply load the variables by name. The assembler checks that `v1` and `v3` are addressable with these instructions and, in the case of the `mov to dx`

from [v3], inserts an `es:` segment override, required because `es` addresses the segment in which `v3` is declared. You can see this if you examine the machine code to this program fragment with Turbo Debugger. Look for hexadecimal 26h, the machine-code value for the `es:` segment override prefix.

Uninitialized Far Data Segments

Another directive `UFARDATA` begins an uninitialized far data segment, similar to an uninitialized regular data segment declared with `UDATASEG`. Because the far segment is not part of a `DGROUP`, it becomes a distinct segment just like a `FARDATA` segment, but with variables containing no predetermined values. Always use the question mark (?) when declaring variables in `UFARDATA` segments. For example:

```
UFARDATA
index    dw    ?
array    db    1024 dup (?)
```

As long as you do not specify any initial values, the variables exist only at runtime. To locate variables in the uninitialized data area, use the symbol `@FarData?` this way:

```
mov     ax, @FarData?
mov     ds, ax
ASSUME ds:@FarData?
```

This assigns the address of the far segment to `ds`. When declaring multiple far data segments with `UFARDATA`, add a name as previously explained for `FARDATA` and assign the value of that name to a segment register and also in an `ASSUME` directive. For example, here are two distinct uninitialized far data segments, each with the capacity to hold 64K of data:

```
UFARDATA BlackHole
space      dw    ?
moreSpace  dw    ?

UFARDATA BlackerHole
deepSpace  dw    ?
deeperSpace dw    ?
```

To initialize `ds` to address `BlackHole` and `es` to address `BlackerHole`, execute the code:

```
CODESEG
mov     ax, BlackHole
mov     ds, ax
mov     ax, BlackerHole
mov     es, ax
ASSUME ds:BlackHole, es:BlackerHole
```

Programming the 80286 and Later Processors

If you are certain that your program will run on a system with an 80286 processor (or a later-model compatible processor), you can use special instructions that Intel introduced with the

80286. If you do this, be aware that your program will not run on systems with 8086 and 8088 processors. To enable the special instructions, use one of the two commands:

- `P286`—Enable all 80286 instructions
- `P286N`—Enable only 80286 non-protected-mode instructions

Most of the time you'll use `P286N`—protected-mode instructions enabled by `P286` are strictly for writing multitasking operating software and are rarely (if ever) useful in applications programming, on which this book concentrates. For more information about writing operating systems, see the Intel and other references listed in the Bibliography.

NOTE

Using the `P286` or `P286N` directives does not limit your code to running on PCs with 80286 processors. Because later-model processors are compatible with the 80286, the directives also enable special instructions for 80386, 80486, and 80586 (Pentium) CPUs. In this section, I refer to all of these processors collectively as the 80286.

Because 80286 flags and registers are identical to those in 8086 processors, you can begin programming the 80286 immediately. (Actually, there are a few new flags, but these are used only by protected-mode instructions that don't concern us here.) In addition, the 80286 recognizes all 8086 instructions as described in this and previous chapters. Table 11.6 lists the new instructions available on 80286 and later processors.

Also refer to Chapter 16, "Assembly Language Reference Guide," for more details on the instructions in Table 11.6. The two string instructions, which can read to and write strings from hardware ports, each have shorthand forms, listed separated here even though the mnemonics represent the identical instructions. The `ins`, `insb`, and `insw` mnemonics represent one instruction, as do the `outs`, `outsb`, and `outsw` mnemonics.

Three instructions `bound`, `enter`, and `leave` were added to the 80286 specifically for use by high-level language compilers, although you can certainly use these instructions in pure assembly code, too, as explained next.

Using the `bound` Instruction

The `bound` instruction verifies that an index is within a specified range—sometimes called *range checking* in a high-level language. Because most such languages make subroutine calls to check array index values, using the `bound` instruction can increase program speed while retaining the safety of using range checks, which many programmers disable to gain speed.

The `bound` instruction requires two operands. The first operand must be a 16-bit register such as `dx` or `bx` containing an index value to be verified by `bound`. The second operand is the

address of a 32-bit doubleword variable in memory containing the low and high ranges allowed for the index value. If the value of the first operand is outside of the specified range, the processor issues an interrupt type 5. Obviously, you also have to install an appropriate interrupt service routine to handle this interrupt.

NOTE

Interrupt type 5 happens to service the “Print Screen” function in ATs and compatibles, resulting in a classic conflict that began with the release of the 8086 and 8088 chips. At that time, Intel reserved interrupt 5 for its own use—a restriction that IBM ignored when it designed the original PC. Later on, when releasing the 80286, Intel claimed its due rights and programmed interrupts into the `bound` instruction. (Of course, the company must have known that this would conflict with the PC’s `PrtSc` key.) So now, if you use `bound` to check array indexes and an index is found to be outside of the allowable range, unless you disable the `PrtScr` key, the error also prints the display contents. Worse, this happens over and over until you reboot. A funny story, but nobody’s laughing.

As an example of how to install a `bound` interrupt handler, Listing 11.6 simulates an index range-checking error. Assemble, link, and run the program with the commands:

```
tasm bound286
tlink bound286,,, mta
bound286
```

Table 11.6. 80286 Instructions (Non-Protected-Mode).

<i>Mnemonic/Operands</i>	<i>Description</i>
<code>bound destination, source</code>	Check array bounds
<code>enter immediate, immediate</code>	Make a procedure stack frame
<code>ins destination, dx</code>	Input string from port
<code>insb</code>	Input string bytes from port
<code>insw</code>	Input string words from port
<code>leave</code>	Leave procedure (after <code>enter</code>)
<code>outs dx, source</code>	Output string to port
<code>outsb</code>	Output string bytes to port
<code>outsw</code>	Output string words to port
<code>popa</code>	Pop all general registers
<code>pusha</code>	Push all general registers

NOTE

Run the following program *only* on systems with an 80286 or later-model processor.

Listing 11.6. BOUND286.ASM.

```

1: %TITLE "Bound Test--80286/386 only! -- by Tom Swan"
2:
3:         P286N
4:         IDEAL
5:
6:         MODEL    small
7:         STACK    256
8:
9:         DATASEG
10:
11: exCode      DB      0
12:
13: errorMsg    db      '**Error: array index out of bounds', 0
14: normalMsg   db      'Program ending with no errors', 0
15:
16: lowRange    DW      100      ; Lowest index range
17: highRange   DW      199      ; Highest index range
18: oldSeg      DW      ?        ; Saves interrupt 5 segment
19: oldOfs     DW      ?        ; Saves interrupt 5 offset
20:
21:         CODESEG
22:
23: ;----- From   STRIO.OBJ
24: EXTRN      StrWrite:proc, NewLine:proc
25:
26: Start:
27:         mov     ax, @data      ; Initialize DS to address
28:         mov     ds, ax         ; of data segment
29:         mov     es, ax         ; Make es = ds
30:
31:         push   es              ; Save es
32:         mov     ax, 03505h     ; Get interrupt 5 vector
33:         int     21h           ; Call DOS
34:         mov     [oldSeg], es   ; Save segment address
35:         mov     [oldOfs], bx   ; Save offset address
36:         pop     es            ; Restore es
37:
38:         push   ds              ; Save ds
39:         mov     ax, 02505h     ; Set new interrupt 5 vector
40:         mov     dx, offset Int5ISR ; To this offset address
41:         push   cs              ; And to this code
42:         pop     ds             ; segment address
43:         int     21h           ; Call DOS
44:         pop     ds            ; Restore ds
45:
46:         mov     bx, 2          ; Assign index value to bx

```

```

47:      bound  bx, [lowRange]          ; Test index range
48:
49:      mov    di, offset normalMsg    ; Display "no errors"
50:      call   StrWrite                 ; message
51:      call   NewLine
52:
53: Exit:
54:      push  ds                        ; Save ds on stack
55:      mov   ax, 02505h                ; Set interrupt 5 vector
56:      mov   dx, [oldOfs]              ; To this offset and
57:      mov   ds, [oldSeg]              ; This segment
58:      int   21h                       ; Call DOS
59:      pop   ds                        ; Restore ds
60:
61:      mov   ah, 04Ch                  ; DOS function: Exit program
62:      mov   al, [exCode]              ; Return exit code value
63:      int   21h                       ; Call DOS. Terminate program
64:
65: ;----- Interrupt 5 service routine: Abort program
66:
67: PROC   Int5ISR
68:      mov   ax, @data                 ; Reset ds and es just
69:      mov   ds, ax                    ; to be safe
70:      mov   es, ax
71:      mov   di, offset errorMsg       ; Address error message
72:      call  StrWrite                  ; Display message
73:      call  NewLine
74:      jmp   Exit                      ; Exit program
75: ENDP   Int5ISR
76:
77:      END    Start                    ; End of program / entry point

```

How BOUND286.ASM Works

Most of BOUND286.ASM is concerned with changing and restoring the vector to interrupt 5, a subject covered in Chapter 10, "Interrupt Handling." The ISR at lines 67–75 is a little different from normal. Instead of preserving and restoring registers as is usually required, the code simply initializes `ds` and `es` (unnecessary, perhaps, but a good idea anyway) and, after displaying an error message, jumps to the program's `Exit` label, halting execution if `bound` detects an error.

Lines 46–47 demonstrate `bound`. Register `bx` is loaded with the index value to check. Change the 2 to 150 (or any other legal index in the range 100–199). When you run the program, you'll receive a different message, proving that the ISR for interrupt 5 was not activated.

Lines 16–17 store the low and high index range values tested by `bound`. These two values must be together in memory and in the order shown here. Although line 47 uses simple direct addressing to locate these values, you can also use other addressing modes with `bound` (see Chapter 4, "Programming in Assembly Language").

Using `enter` and `leave`

The `enter` and `leave` instructions are useful for preparing procedure stack frames, allocating and reclaiming stack space for local variables in subroutines. Such variables are dynamic—existing only for as long as the procedure runs. These methods are usually employed by high-level languages as part of their procedure and function implementation methods, but you can use the instructions in pure assembly code if you want. (See Chapters 12, “Mixing Assembly Language with Pascal,” and 13, “Mixing Assembly Language with C and C++,” for more information on addressing local stack variables.)

Use `enter` as the first instruction in a procedure. `Enter` takes two operands, both of which must be literal numbers. (The operands can be expressions or equates as long as the result is a literal number.) The first operand represents the number of bytes to reserve on the stack. The second operand represents the procedure’s nesting level. If three procedures nest inside each other, the innermost procedure is at level 2, the middle procedure is at level 1, and the outer procedure is at level 0. Nesting levels are provided mostly to handle languages such as Pascal, which allow nested (child) procedures to access local variables declared in outer (parent) procedures.

When `enter` executes, it performs the work of three 8086 instructions:

```
push    bp           ; Save current bp
mov     bp, sp       ; Assign stack pointer to bp
sub     sp, n         ; Allocate stack space for variables
```

First, `bp` is pushed into the stack, preserving its current value. Then the stack pointer `sp` is assigned to `bp`, allowing instructions to use this register to address the procedure’s local variables. Space for the variables is then allocated by subtracting the value of `enter`’s first parameter `n` from the stack pointer.

In any procedure that uses `enter`, execute `leave` just before `ret` to reclaim the stack space allocated by `enter` and to restore `sp` and `bp`. The `leave` instruction performs the same jobs as these two 8086 instructions:

```
mov     sp, bp       ; Restore stack pointer from bp
pop     bp           ; Restore saved bp
```

Copying `bp` to `sp` reclaims any space allocated on the stack before restoring the saved value of `bp`, which may be used by other procedures to address their own local variables. As an example of a complete procedure that uses `enter` and `leave`, here’s a sample subroutine that allocates space for four word variables on the stack:

```
P286N
PROC AnyProc
    enter    8, 0          ; Reserve 8 bytes on stack
    mov     [word bp - 0], 4 ; Assign 4 to v1
    mov     [word bp - 2], 3 ; Assign 3 to v2
    mov     [word bp - 4], 2 ; Assign 2 to v3
    mov     [word bp - 6], 1 ; Assign 1 to v4
    leave   ; Reclaim reserved stack space
    ret     ; Return to caller
ENDP AnyProc
```

The `enter` instruction reserves 8 bytes of stack space—room for four word variables. The instruction also prepares `bp` to address the variables, as illustrated by several `mov` instructions. The first word is at `[bp - 0]`, the second is at `[bp - 2]`, and so on. In place of `word`, you can specify `byte`, `dword`, and other qualifiers to address data of different sizes. The `leave` instruction reclaims the stack space used by the local variables (also destroying their values in the process) and restores `sp` and `bp`, preparing for the `ret` instruction.

Using `pusha` and `popa`

Two instructions `pusha` and `popa` all general-purpose registers, usually at the beginning and end of an interrupt service routine, although you might use the instructions in procedures, too. Execute `pusha` to push registers `ax`, `cx`, `dx`, `bx`, `sp`, `bp`, `si`, and `di` in that order. Notice that the stack pointer is also pushed. But the value copied to the stack for `sp` equals the value of `sp` *before* executing `pusha`.

The complementary instruction `popa` removes all general-purpose registers from the stack. Executing `popa` (usually after a previous `pusha`) pop registers `di`, `si`, `bp`, `sp`, `bx`, `dx`, `cx`, and `ax` in that order. Technically, the value for `sp` is discarded because, if `popa` actually restored `sp` before popping the remaining `di`, `si`, and `bp`, these registers would receive the wrong values and the stack would shrink by three words too many. The effect of `popa` is just what you probably expect: all general-purpose registers are restored to the values they had before the most recent `pusha`. Segment registers are not saved and restored by `pusha` and `popa`.

Reading and Writing Port Strings

The two 80286 (and later-model CPU) string instructions `ins` and `outs` read and write strings at hardware ports specified by `dx`. These instructions and their shorthand forms (see Table 11.6) operate similarly to other string instructions. In the case of `ins`, registers `es:di` address an area where the string data is to be stored. Executing `ins` reads one byte or word from the specified port, storing the data at `es:di`. If `df = 0`, then `di` is incremented by 1 for bytes or by 2 for words. If `df = 1`, then `di` is decremented by like amounts. Usually, `ins` is prefaced by the `rep` prefix and a count in `cx` to load multiple bytes and words with code such as:

```

DATASEG
string db 80 dup (?)
strlen = $ - string
CODESEG
P286N
mov dx, port number ; Assign port number to dx
mov ax, SEG string ; Address segment containing
mov es, ax ; string with es
ASSUME es:SEG string ; Tell tasm where es points
mov di, offset string ; Address string with es:di
mov cx, strlen ; Assign repeat count to cx
cld ; Auto-increment di
rep insb ; Load string bytes from port

```

To complete this example, you must load an actual port number into `dx`. Even then you may not be able to run this code unless your system has a port from which you can read strings. (Most PCs don't.) Still, this demonstrates how to use `insb` for peripherals or custom systems with the appropriate hardware.

You can use similar code to write strings to output ports. With the `outs` instruction, the port number is in `dx`, and `ds:si` addresses the source string data. Or you can use an override to address strings with `es` as in:

```

cld
rep outs dx, [byte es:si] ; Output string to port

```

Usually, `outs` is used as in this sample with a repeat prefix and a count in `cx` to send multiple bytes and words to hardware ports. If `df = 0`, then `si` is incremented by 1 for bytes or by 2 for words. If `df = 1`, then `si` is decremented by like amounts.

Immediate Shift and Rotate Values

A subtle improvement in 80286 instructions is the ability to specify immediate shift and rotate values greater than 1. This means that the 8086 instructions:

```

mov cl, 4 ; Assign shift count to cl
shl ax, cl ; Shift ax left four times

```

can be simplified to:

```

shl ax, 4

```

This same change applies to all 8086 shift and rotate instructions. You can still specify a shift count in `cl` if necessary.

Programming the 80386

If your system has an 80386 or later-model processor, you have all of the 8086 and 80286 instructions at your disposal—plus the advantage of extra-speedy processing, as you no doubt

already know. As with the 80286, the 80386 and successors have protected- and non-protected-mode instructions. With few exceptions, the protected-mode instructions are identical to those in the 80286. In addition to running in protected and non-protected modes, the new processors include a third mode for running programs in a *virtual 8086 machine*. Such advanced programming techniques are the realm of multitasking software such as Xenix, OS/2, and Windows. As mentioned earlier, Turbo Debugger can run programs in this mode for better control over system crashes, accesses to restricted memory locations, and so on. There isn't room here to describe how to write operating system software, but the good news is that if you stick to 8086 instructions, no matter what mode the 80386 is in, your programs will run.

If you are certain your program will be executed on an 80386 or later, you can take advantage of several additional instructions listed in Table 11.6.

Starting to Program the 80386

Figure 11.3 illustrates the 80386-family 32-bit registers and flags. Notice that all the 8086 registers are available but are extended to a full 32-bit width. Segment registers are identical, although there are two more (fs and gs). You can use the extended registers with most 8086-type instructions. For example, to clear the 32-bit accumulator, write:

```
P386N
xor    eax, eax
```

To enable 80386 instruction, use the P386N (non-protected mode) or P386 (all modes) directives. You can do this on any system—you don't have to have an 80386 to assemble and link your program. Of course, you must have an 80386 or later processor to run the resulting code.

Many of the instructions in Table 11.7 are 32-bit variations of the similar 8086 instructions you already know how to use. For example, `cmpsd` works identically to `cmps` (Compare Strings) but adds the ability to compare doubleword values in addition to the usual bytes and words. Similarly, `insd`, `lods`, `movsd`, `outsd`, `scasd`, and `stosd` add doubleword abilities to the 8086 string instructions `lods`, `movs`, and `scas` plus the 80286 instructions `ins` and `outs`. Other instructions use 32-bit extended registers to perform operations similar to those available on the 8086 and 80286. There are also a few newcomers, as described in the following sections.

NOTE

For more details on all the instructions in Table 11.7, please refer to Chapter 16.

Scanning and Setting Bits

Use `bsf` (Bit Scan Forward) and `bsr` (Bit Scan Reverse) to load a register with the position number of the first bit equal to 1 found in a byte, word, or doubleword. Forward scans go from the LSD (bit 0) to the MSD; reverse scans go the other way, from the MSD to the LSD. If no bits equal to one are found, `zf` is set to 0. One way to use the instructions is to set `cl` to the number of bits required to shift a single bit to the LSD position. For example:

```
P386N
mov bx, 00100000b      ; Set bit 5 to 1
xor cl, cl             ; Zero cl in case all bits = 0
bsf cx, bx             ; Scan from bit 0 to 15
shr bx, cl             ; Shift bit into LSD position
@@10:
```

In this sample, the value to test is in `bx`, shown here in binary for clarity. Bit number 5 in the value equals 1; therefore, the `bsf` instruction sets `cx` to 5. After this, `shr` shifts `bx` to move the single bit to the LSD position. In this case, both `bsf` and `bsr` produce the identical results. But consider the case where more than one bit equals 1:

```
P386N
mov bx, 00010110b     ; Set bits 1, 2, and 4
bsf cx, bx            ; Sets cx to 1
bsr cx, bx            ; Sets cx to 4
```

The `bsf` instruction locates the first 1 bit starting from bit 0, thus setting `cx` to 1. The `bsr` instruction scans in the other direction, setting `cx` to 4—the position of the first 1 bit from MSD in `bx`.

Table 11.7. 80386 Instructions (Non-Protected-Mode).

<i>Mnemonic/Operands</i>	<i>Description</i>
<code>bsf destination, source</code>	Bit scan forward
<code>bsr destination, source</code>	Bit scan reverse
<code>bt destination, source</code>	Bit test
<code>btc destination, source</code>	Bit test and complement
<code>btr destination, source</code>	Bit test and reset
<code>bts destination, source</code>	Bit test and set
<code>cdq</code>	Convert doubleword to quadword
<code>cmps</code>	Compare string doublewords
<code>cwde</code>	Convert word to extended doubleword
<code>insd</code>	Input string doublewords
<code>lfs destination, source</code>	Load pointer and fs
<code>lgs destination, source</code>	Load pointer and gs

Testing Bits

The `bt`, `btc`, `btr`, and `bts` instructions all do similar but slightly different jobs. Each instruction takes two operands. The operands may each be a 16- or 32-bit register; the second operand may also be an immediate value. Whatever its form, the second operand represents the bit number to copy from the first operand to the carry flag. For example, this sets `cf` to 1:

```
mov dx, 00100000b    ; Set bit 5 to 1
bt  dx, 5            ; Copy bit 5 to cf
```

The other three instructions work exactly the same way but have different effects on the bit in the original value after copying the bit to `cf`. The `btc` instruction complements (toggles) the original bit; `btr` resets the original bit to 0; and `bts` sets the bit to 1. A few examples help make this clear:

```
mov dx, 01010011b    ; Assign initial value to dx
btc dx, 7            ; cf = 0; dx = 11010011 (bit 7 <- 0)
btr dx, 0            ; cf = 1; dx = 11010010 (bit 1 <- 0)
bts dx, 3            ; cf = 0; dx = 11011010 (bit 3 <- 1)
```

The `btc` instruction in this sample copies bit 7 of `dx` to `cf` and complements the original bit in `dx`. The `btr` instruction copies bit 0 to `cf` and then resets that bit to 0. The `bts` instruction copies bit 3 to `cf` and then sets that bit to 1.

More Conversions

In addition to `cbw`, which converts bytes to words, and `cwd`, which converts words to doublewords, you can use `cdq` to convert 32-bit doublewords to 64-bit quadwords and `cwde` to convert words to doublewords in the extended accumulator `eax`. These instructions are useful when working with signed integers of different sizes. A simple example explains how to use the new 80386 additions:

```
mov    ax, -3        ; Set ax to -3 (ax = 0FFFDh)
cwde                   ; Sets eax to -3 (eax = 0FFFF FFDh)
cdq                    ; Sets edx:eax to -3 (edx = 0FFFF FFFFh;
                        ;                    eax = 0FFFF FFDh)
```

The 16-bit value in `ax` (-3) is converted to the full 32-bit width of the extended accumulator `eax` by `cwde`. This value is then further extended into two registers `edx` and `eax`. In all cases, register assignments are fixed as shown here—you can only extend values in `ax` to `eax` and `edx`. You can't extend values in other general-purpose registers.

Other 80386 Instructions

You can load pointers into general-purpose registers plus the two additional segment registers `fs` and `gs` with `lfs` and `lgs`. A third instruction `lss` lets you initialize `ss` and `sp`. These

operate identically to `les` and `lds` but load segment values into the specified segment registers. For example:

```

DATASEG
ptr48    dw        1, 2, 3
CODESEG
P386N
lfs      ebx, [pword ptr48]    ; Loads ptr48 into fs:ebx
lgs      edi, [pword ptr48]    ; Loads ptr48 into gs:edi
;lss     esp, [pword ptr48]    ; Loads ptr48 into ss:esp

```

Notice the `pword` qualifier to the memory reference in the second operand of each instruction. This tells Turbo Assembler that the variable, declared here with a multipart `dw` directive, is really a 48-bit pointer (16-bit segment and 32-bit offset). The `lfs` instruction sets `ebx` to `000200001h` and `fs` to `0003h`, picking up these values at label `ptr48` in data segment. Similarly, the `lgs` instruction sets `edi` to `000200001h` and `gs` to `0003h`. The `lss` instruction sets `ss` and `esp` to similar values but probably also crashes the system. For this reason, the `lss` instruction is shown here as a comment. You must exercise great care when using `lss` to change the stack segment and pointer.

Other useful instructions include two more commands `movsx` and `movzx`. Use these to assign signed and unsigned values from small registers or memory variables to larger registers. With both instructions, the first operand must be a 16- or 32-bit extended register. The second operand may be an 8- or 16-bit register or memory reference. For example, if you have a signed 8-bit value in `bl`, you can transfer the value to a 16-bit register `dx` with:

```

mov      bl, -7                ; Initialize bl to -7 (8 bits)
movsx   dx, bl                 ; Sets dx to -7 (16 bits)

```

Or you can copy a 16-bit value to a 32-bit register with:

```

mov      dx, -8                ; Initialize dx to -8 (16 bits)
movsx   eax, dx                ; Sets eax to -8 (32 bits)

```

Use `movzx` to do the same, but with unsigned values. For example:

```

mov      bl, 255                ; Initialize bl to 255 (8 bits)
movzx   ax, bl                 ; Set ax to 255 (16 bits)
mov      bx, 25890              ; Initialize bx to 25,890 (16 bits)
movzx   eax, bx                ; Set eax to 25,890 (32 bits)

```

Similar to the 80286 `pusha` and `popa` instructions, use `pushad` and `popad` to push and pop all 32-bit general-purpose extended (doubleword) registers. Execute `pushad` to push registers `eax`, `ecx`, `edx`, `ebx`, `esp`, `ebp`, `esi`, and `edi` in that order. The value pushed for `esp` equals the value of the stack pointer *before* executing `pushad`. Execute `popad` to remove these same registers from the stack in this order: `edi`, `esi`, `ebp`, `esp`, `ebx`, `edx`, `ecx`, and `eax`. The value for `esp` is discarded, although `esp` is still restored to the same value it had prior to `pushad`.

One other instruction set-condition is similar to a conditional jump. The effect, however, is to set a byte register or memory value to 1 or 0 depending on whether the specified condition is satisfied. For instance:

```
cmp    ax, 1
sete   bh
```

sets bh to 1 only if ax equals 1. The endings to set are the same as for the conditional jump instructions: setb, seta, setz, setnl, and so on. See set-condition in Chapter 16 for a complete list of mnemonics and flag settings tested by this instruction.

Double-Precision Shifts

The last two instructions to cover are shld and shrd, which take an unusual three operands. In most cases, when you need to shift 32-bit registers, you can just use the 8086 shift and rotate instructions such as shr and rcr, specifying an extended register as in:

```
mov    eax, 4      ; Initialize eax to 4 (32 bits)
shl    eax, 3      ; Multiply eax by 8
```

The doubleword shift instructions operate a bit differently. The first operand to shld and shrd specifies the destination and may be a word or doubleword register or memory reference. The second operand, which must be a word or doubleword register, holds the bits to be shifted into the first operand. The third operand represents the number of bits to be shifted in the indicated direction (right for shrd and left for shld). This operand may be an immediate value 0 to 31 or the register cl. For example:

```
shld   eax, ebx, 4 ; Shift first 4 bits of ebx -> eax
```

shifts 4 bits from ebx and eax. The value in ebx does not change. Loops with shld or shrd instructions are especially useful for performing multiple-precision shifts on very large values. For a more complete example of how this works, see the sample code in Chapter 16 for shld.

The VERSION Directive

Turbo Assembler 4.0 adds a new VERSION directive that replaces some other directives in earlier assemblers. For example, some TASM releases used the QUIRKS symbol, now obsolete, to emulate various Microsoft Assembler (MASM) syntactical oddities.

You can use VERSION to assemble programs written for most versions of MASM and TASM. Table 11.8 lists the arguments you can specify. For example, to assemble a TASM 2.5 program using Turbo Assembler 4.0, insert this directive somewhere near the beginning of the source listing:

```
VERSION T250
```

Table 11.8. VERSION arguments.

<i>Argument</i>	<i>Assembler</i>	<i>Version</i>
M400	MASM	4.0
M500	MASM	5.0
M510	MASM	5.1
M520	MASM	5.2 aka Quick ASM
T100	TASM	1.0
T101	TASM	1.01
T200	TASM	2.0
T250	TASM	2.5
T300	TASM	3.0
T310	TASM	3.1
T320	TASM	3.2
T400	TASM	4.0

The VERSION directive replaces these symbols found in previous assembler releases:

```
MASM51, NOMASM51, QUIRKS, SMART, NOSMART
```

Enumerated Data Types

Equating names and numbers is a time honored programming technique for writing understandable computer programs—in any language, not just assembly. For example, in the absence of any explanation, this instruction is meaningless:

```
mov    al, 8
```

Of course, that moves the value 8 into the a1 register. But what does 8 represent? In a calendar program, it might represent the month of October. In a game, it might represent a level of play. There's no telling what this program is doing.

You might add a comment to make the program more understandable:

```
mov    al, 8 ; Assign October to al
```

But why not go the extra mile and create a *symbol* that represents the number mnemonically? For example, you can define a symbol OCTOBER that is equivalent to the value 8:

```
OCTOBER EQU 8
```

You can then use the symbol in the program, making the purpose of statements perfectly clear without the need for clarifying comments:

```
mov    a1, OCTOBER
```

An enumerated data type is a programming technique that automates the equating of symbols and numbers (most often sequential ones). Rather than type EQU directives and assign literal values, you can use an ENUM directive to create a series of symbols.

For example, in a program that uses the days of the week, you might create an enumerated data type like this:

```
ENUM ETDays SUN, MON, TUE, WED, THU, FRI, SAT
```

The data type, ETDays, represents the symbols SUN through SAT, which are internally represented as the numeric values 0 through 6. By convention, I precede the data type name with ET for “enumerated type,” but you can use another name if you want.

An enumerated data type is just a declaration—it doesn’t occupy any memory in the final program. To use an enumerated data type, in addition to declaring it, you must define space for an object of that type, usually in the program’s data segment. For example, this creates a variable named aDay of the data type ETDays:

```
aDay  ETDays  ?
```

That is roughly equivalent to a DB directive. The question mark indicates that the variable is undefined, and its memory will be allocated at runtime. To define an explicit value for an enumerated variable, specify an initial value like this:

```
aDay  ETDays  WED
```

That creates a variable named aDay initialized to the symbol WED. Internally, this stores 3 in aDay, but that fact is unimportant in this symbolic representation.

Enumerated data types are used the same as equated symbols. The preceding day names, for example, are similar to individual equates:

```
SUN EQU 0  
MON EQU 1  
...  
SAT EQU 6
```

But there’s an important difference between equated symbols and enumerated data types. Not only does the assembler assign the symbolic values for you, with ENUM, the assembler can also guard against some kinds of improper operations. For instance, you might attempt to assign the symbol TUE as a 16-bit word to a variable in memory:

```
mov  ax, TUE  
mov  [aDay], ax
```

This produces the error message *Operand types do not match* because the second statement attempts to store a word in the 8-bit variable. Because the enumerated data type is a byte, storing a 16-bit value in it is illegal. The correct code is:

```
mov  a1, TUE
mov  [aDay], a1
```

With individually equated symbols, the assembler cannot detect this kind of error. Enumerated data types can therefore help prevent bugs.

An alternate multiline form of the `ENUM` directive is sometimes useful. Here's how you might use it to declare a set of month names:

```
ENUM ETMonths {
  JANUARY
  FEBRUARY
  MARCH
  APRIL
  MAY
  JUNE
  JULY
  AUGUST
  SEPTEMBER
  OCTOBER
  NOVEMBER
  DECEMBER
}
```

The end result is a set of enumerated symbols, `JANUARY` through `FEBRUARY`, that are equated with the sequential values 0 through 11. Notice that when using this form, the symbols are written on separate lines between braces, and are not separated with commas.

Sometimes, you might want to change the values associated with enumerated symbols. For example, `JANUARY` is conventionally associated with 1, `FEBRUARY` with 2, and so on. To change the value associated with a symbol, assign it a new value like this:

```
ENUM ETMonths {
  JANUARY = 1
  FEBRUARY
  MARCH
  ...
  DECEMBER
}
```

You can make similar assignments to any one or more enumerated symbols. The next symbol is one greater. `FEBRUARY`, in other words, is now equal to 2, `MARCH` is 3, and so on.

Create a variable of the `ETMonths` data type like this:

```
aMonth ETMonths ?
```

Then, assign it a value using statements such as:

```
mov    al, SEPTEMBER
mov    [aMonth], al
```

Getting SMART

With the `SMART` directive enabled, Turbo Assembler can help you to write more efficient assembly language programs. With this directive, the assembler replaces some types of instructions with shorter or faster ones. Turn on smart-code generation by adding the directive near the beginning of your program's listing:

```
SMART
```

Turn off smart code by inserting `NOSMART`:

```
NOSMART
```

TIP

You might want to use `NOSMART` when debugging a program so that you see the actual instructions you write. With `SMART` in effect, during debugging, Turbo Debugger's CPU window may show instructions that you didn't write.

Smart Effective Addresses

Using `SMART`, Turbo Assembler can replace some kinds of address calculations with more efficient offsets. For example, suppose you want to address a variable defined in a data segment:

```
DATASEG
data    DW    ?
```

You can use the `lea` (load effective address) instruction to load the address of data into a register:

```
CODESEG
lea    ax, [data]
```

That instruction, however, is wasteful of time and memory. A shorter, faster instruction that performs the identical operation simply moves the *offset* address of data (relative to its data segment) into `ax`:

```
mov    ax, offset data
```

With SMART code generation, Turbo Assembler automatically replaces the `lea` instruction with an equivalent `mov`, which takes fewer bytes and is faster. The assembler makes the replacement only when the target address can be equated to a relative offset.

Sign-Extended Boolean Operations

Some instructions such as `and` have sign-extended forms that take a byte or two less memory. Turbo Assembler's SMART directive can select these more efficient instructions automatically. For example, this code fragment defines a word of data, and then performs a logical `and` on it with a mask of `-2`:

```
DATASEG
data    DW    1234h
CODESEG
and     [data], -2
```

Under normal circumstances, the `and` instruction is assembled using a 16-bit literal form of the instruction, encoded in machine language as the following code stream bytes (the assembled instruction is shown at right):

```
81260100FEFF    and word ptr [0001],FFFE
```

The hexadecimal value `FFFE` (the byte order is swapped in the instruction) represents `-2` as a 16-bit literal value. That value, however, can be more efficiently represented as the hexadecimal byte `FE` by using the sign-extended form of the `and` instruction, which *extends* the byte internally to a word. With SMART code generation in effect, Turbo Assembler selects this alternate `and` instruction by writing these bytes to the code stream:

```
83260100FE      and word ptr [0001],FFFE
```

Call Me Smart

When calling far subroutines from within the same code segment, the following instruction generates inefficient code:

```
call far Subroutine
```

In this case, it is more efficient to push the current code segment register (`cs`) onto the stack and execute a near `call`:

```
push cs
call near Subroutine
```

This has the same effect but is faster. With SMART code generation enabled, Turbo Assembler automatically replaces far calls with a push and a near call when source and target code segment addresses are the same.

NOTE

My tests indicate that, contrary to Borland's documentation on SMART code generation, the NOSMART directive does *not* turn off intrasegment call-instruction optimization. Although this appears to be a bug in Turbo Assembler 4.0, it's hard to imagine any good reason for disabling this feature, so the problem is a minor one.

Pushy Pushy

The 80386 and later processors permit pushing constant values onto the stack. This can be useful for passing arguments to functions. For example, using only 8086 instructions, you must load a register and push it onto the stack like this:

```
mov    ax, 10    ; Load value into ax
push  ax        ; Push value onto stack
call  Subroutine ; Call a subroutine
pop   ax        ; Pop value from stack
```

With the 80386 and later processors, you can push a literal constant value directly, replacing the preceding code with:

```
push  10        ; Push value onto stack
call  Subroutine ; Call a subroutine
pop   ax        ; Pop value from stack
```

For better portability of programs, Turbo Assembler's SMART code generation makes it possible to use the same technique even on 8086 processors in which the push instruction cannot push constant values. If you enable only 8086 instructions by inserting the `!8086` directive into a program, Turbo Assembler replaces the preceding code with the following instructions:

```
push  ax        ; Punch a hole into the stack
push  bp        ; Save current bp register
mov   bp,sp     ; Address stack with bp
mov   word ptr [bp+02],000A ; Drop value into hole
pop   bp        ; Restore saved bp
```

This sequence employs a cute trick for inserting constant values into the 8086 stack. The first push instruction “punches a hole” in the stack's memory, creating a space in which the constant value will be inserted. The second push saves bp for addressing the stack. After setting bp equal to sp, a mov instruction drops the constant value 10 (000A hexadecimal) into the punched hole. Finally, pop restores the saved bp value.

NOTE

You still must follow the preceding code with a `pop` to remove the pushed word from the stack. Turbo Assembler does not do this for you.

Some Additional Instructions

Turbo Assembler 4.0 adds several new instruction mnemonics to those specified for 80386 and later-model processors. These aren't new instructions. They are selectors for different, and sometimes more efficient, instruction forms that may come in handy from time to time. The following sections discuss how to use the alternate instructions.

NOTE

All sample programming in the next sections require an 80386 or later-model processor. Use the `P386` directive in your program to enable the instructions.

Loop the Loop

The `loop` instruction is one of the most useful in the 8086 instruction set. With it, you can set a loop count in `cx`, and automatically create a loop that cycles for the specified number of times. For example, this code fragment uses `loop` to call a subroutine (not shown):

```
mov     cx, 10      ; Set loop count in cx
@@99:
call   Subroutine  ; Call subroutine
loop  @@99         ; loop on cx
```

The `loop` instruction decrements `cx`, and if the register is nonzero, jumps to the designated label (`@@99`).

All of this works fine until you begin programming with 32-bit code segments using the 80386 and later processors. Under normal circumstances, Turbo Assembler assembles `loop` instructions that use the `cx` register if the code segment is the 16-bit variety, but that use the `ecx` 32-bit register for 32-bit code segments.

If you want to use the 16-bit `cx` register in a 32-bit code segment `loop` instruction, you are out of luck—unless, that is, you employ one of the alternate `loop` instructions provided by Turbo Assembler. For example, you can use `loopw` (the *w* stands for *word*):

```
loopw  @@99 ; Loop on 16-bit cx
```

This is *not* a new instruction. It simply specifies that `cx` should be used as the loop counter even in a 32-bit code segment. Likewise, you can use the extended 32-bit `ecx` register as a counter in a 16-bit code segment by employing the alternate `loopd` (the `d` stands for *doubleword*) instruction:

```
loopd    @@99 ; Loop on 32-bit ecx
```

The above form is especially useful for writing loops that must cycle more than 65,536 times.

As you may recall, there are five standard loop instructions—`loop`, `loope`, `loopz`, `loopne`, and `loopnz`. (Look them up in Chapter 16, “Assembly Language Reference Guide,” if you need a refresher on what these instructions do.)

To those instructions, append `w` after `loop` to select the word (16-bit `cx`) alternate forms—`loopw`, `loopwe`, `loopwz`, `loopwne`, and `loopwnz`. Append `d` after `loop` to select the doubleword (32-bit `ecx`) forms—`loopd`, `loopde`, `loopdz`, `loopdne`, and `loopdnz`.

Enter or Leave When Ready

Earlier in this chapter, I explained how to use `enter` and `leave`. When using an 80386 or later-model processor and 32-bit code segments, the assembler normally inserts instructions that select the extended `ebp` and `esp` 32-bit registers for these instructions.

As with the `loop` instruction, you can use alternate forms of `enter` and `leave` to force the use of 16- or 32-bit registers regardless of the segment size. Replace `enter` with `enterw` and `leave` with `leavew` to select 16-bit `bp` and `sp` register instructions. Replace `enter` with `enterd` and `leave` with `leaved` to select 32-bit `ebp` and `esp` register instructions.

Return to Sender

Programming the 80x86 processor family requires constant attention to address formats. When calling subroutines, for example, you need to use a near 16-bit `call` if that subroutine returns via a near `ret` instruction. Using Ideal mode, `PROC` directives, and simplified memory models, however, you can usually ignore these facts and let Turbo Assembler choose the correct `call` and `ret` instructions for you.

In cases where you want more control over your subroutine instructions, you may specify `retn` to always select a near, 16-bit return instruction. Or, use `retf` to always select a far, 32-bit return. When you do that, it is your responsibility to use the correct `call` instruction. Preface the subroutine address with `near` or `far` as needed:

```
call near Subroutine ; Must return via retn
call far Subroutine  ; Must return via retf
```

Alternatively, you may use the `retcode` instruction with Turbo Assembler 2.0 or greater. This instruction automatically selects a near or far return based on the current memory model.

TIP

Assemble some test programs and examine them with Turbo Debugger to verify that `retcode` inserts the expected return instructions.

Interrupting 32-Bit Code Segments

When using 32-bit code segments along with interrupt service routines, Turbo Assembler normally selects an interrupt-return instruction based on the current code segment size. This affects the size of register values popped from the stack. In 32-bit code segments, doubleword registers are popped; in 16-bit code segments, word registers are popped.

Usually, the default instructions are what you want. If, however, you want to force the assembler to pop 16-bit word registers in a 32-bit code segment, use the `iretw` instruction in place of `iret`. If you want to pop 32-bit extended registers in a 16-bit code segment, use `iretd`.

More Pushy Instructions

Another set of instructions select among 16- and 32-bit `pusha`, `popa`, `pushf`, and `popf` instructions (see the reference in Chapter 16 for information on what they do). Normally, these instructions push and pop 16-bit registers and flags in 16-bit code segments, and 32-bit extended registers and flags in 32-bit code segments.

Alternate forms of these instructions always push specific registers regardless of code segment size. Use `pushaw`, `popaw`, `pushfw`, and `popfw` to push and pop 16-bit registers and flags. Use `pushad`, `popad`, `pushfd`, and `popfd` to push and pop 32-bit registers and flags.

NOTE

Turbo Assembler's User's Guide incorrectly documents these alternate instructions (it doesn't even mention the doubleword instruction forms). The preceding information is based on test programs—you should use Turbo Debugger to verify that the correct instructions are inserted into your programs.

Shifty Instructions

The 80386 and later processors provide an alternate form of rotate and shift instructions `rcl`, `rcr`, `rol`, `ror`, `shl`, `shr`, `sarl`, and `sar`. For example, to shift the contents of the accumulator `ax` left three bit positions, you can use the instruction:

```
shl    ax, 3
```

The 8086 processor, however, can shift values only one bit position at a time when a constant is used to specify the shift count. Using 8086 code (insert a `PM8086` directive in your program), you must write three separate instructions to perform the preceding operation:

```
shl    ax, 1
shl    ax, 1
shl    ax, 1
```

So you can use the newer form in 8086 programs, Turbo Assembler replaces shift constant values greater than one with the appropriate number of individual shift instructions when 8086-code generation is in effect.

Fast Multiplications

Assembly language programmers take great pride in finding the most efficient methods for performing a variety of operations. Multiplying two values quickly, for example, is often possible by using combinations of shift and other logical instructions rather than the `imul` (integer multiply) instruction. (Look it up in the function reference if you are not familiar with it.)

Toss in the complication of writing code for multiple processors, from the 8086 to the 80386, and it becomes doubly tough to find the best instruction sequences for multiplications. That's why Turbo Assembler 3.0 introduced a new pseudo instruction, `FASTIMUL`, which generates the most efficient instructions for multiplications, on all processors.

Some examples show how to take advantage of this new command. `FASTIMUL`'s syntax is:

```
FASTIMUL destination_reg, source_r/m, value
```

The first argument must be a destination register—the place where you want to store the result of a multiplication. The second argument may be a register or a memory reference to a variable. The third argument must be a literal value. In place of `FASTIMUL`, Turbo Assembler generates one or more instructions that multiply the value times the source, and store the result in the destination. You may use 32-bit registers with appropriate processors such as the 80386 and 80486.

`FASTIMUL` is deceptively simple to use, but the results may surprise you. The following, for example, multiplies `bx` times 4, and stores the result in `ax`:

```
FASTIMUL ax, bx, 4
```

Because it is more efficient to perform this multiplication using a shift-left instruction, Turbo Assembler writes the following instructions in place of `FASTIMUL`:

```
shl    bx, 02
mov    ax, bx
```

Similarly, with an appropriate processor, you can multiply 32-bit registers:

```
P386
FASTIMUL eax, ebx, 4
```

In place of the FASTIMUL instruction, Turbo Assembler generates the following 32-bit code:

```
shl ebx,02
mov  eax,ebx
```

Specifying a 16-bit processor model such as the 8086 generates a different sequence. Consider the same multiplication using the P8086 directive:

```
P8086
FASTIMUL ax, bx, 4
```

The FASTIMUL in this case generates three instructions because shifts on the 8086 can move only one bit position at a time:

```
shl bx,1
shl bx,1
mov  ax,bx
```

The preceding examples merely scratch the surface of what FASTIMUL can do. A less obvious optimization occurs when multiplying by a literal value that is not a power of two. Consider this instruction with 8086-code generation in effect:

```
P8086
FASTIMUL ax, bx, 3
```

In place of this FASTIMUL, Turbo Assembler generates the following three instructions:

```
mov  ax, bx
shl  bx, 1
add  ax, bx
```

It takes a bit of mental effort to verify that these instructions actually multiply `bx` by 3, and it takes more than a little insight to realize that the resulting code is the most efficient solution. Many assembly language programmers, for example, would probably write the following code:

```
mov  al, 16
mov  bl, 3
imul bl
```

As a general rule, *any* replacement for an `imul` instruction that uses immediate values (3 in this case) is probably better because of the numerous CPU cycles that this time-wasting instruction consumes. In some cases, however, and especially with 32-bit processors such as the 80386 and 80486, `imul` might still be the best choice, as this example shows:

```
P386
FASTIMUL eax, ebx, 123456
```

Multiplying `ebx` by the literal value 123456 is best done by an `imul` instruction, which Turbo Assembler generates for the preceding `FASTIMUL` command:

```
imul  eax, ebx, 0001E240
```

Similarly, with 80386 or later-model code generation in effect, the assembler uses an `imul` instruction for non-simple literal operands (such as 1234 in this 16-bit multiplication):

```
P386
FASTIMUL ax, bx, 1234
```

In place of this `FASTIMUL`, the assembler generates the `imul` instruction:

```
imul  ax, bx, 04D2
```

That instruction, however, is not available to 8086 processors, which have only a limited form of `imul`. When generating code for the 8086, you can use `FASTIMUL` instructions not only for efficiency's sake, but also to improve portability. For example, if you specify the `P8086` directive for the same multiplication as before:

```
P8086
FASTIMUL ax, bx, 1234
```

the assembler generates the following sequence of shift and add instructions:

```
shl   bx, 1
mov   ax, bx
shl   bx, 1
shl   bx, 1
shl   bx, 1
add   ax, bx
shl   bx, 1
shl   bx, 1
add   ax, bx
shl   bx, 1
add   ax, bx
shl   bx, 1
shl   bx, 1
shl   bx, 1
add   ax, bx
```

Although this works, and it does make it possible to write portable multiplication instructions for all 80x86 processors, you should be aware that `FASTIMUL` can in some cases cause your code file to balloon in size.

Summary

Binary-coded-decimal values store 20-digit numbers in a format that's easy to convert to and from ASCII characters. Packed BCDs store 2 digits per byte. Unpacked BCDs store 1 digit per byte. The `dt` directive creates 20-digit packed BCD variables. Although there is no similar directive to create unpacked BCD variables, `db` is an adequate substitute.

The `aaa` and `aas` instructions adjust binary results after adding and subtracting unpacked BCD values back to unpacked BCD format. The `aad` and `aam` instructions convert between binary and unpacked BCD values. Despite the suggestive names of these two instructions, they don't have to be used in conjunction with division and multiplication. Converting unpacked BCDs to and from ASCII takes only a simple `and` or `or` instruction because of the ASCII encoding scheme used for digits 0-9. The `daa` and `das` instructions adjust binary results after adding and subtracting packed BCD values back to packed BCD format.

Communal variables, which can't be assigned initial values, are declared with the `COMM` directive. Similar to communal variables, global variables declared with the `GLOBAL` directive can have initial values and can be shared among multiple modules. `GLOBAL` eliminates the need to declare variables `PUBLIC` in one module and `EXTERN` in others—just put all your global declarations in one or two files and assemble and link your application using `INCLUDE` directives to load global definitions into individual modules. In large projects, you may also want to specify a default library file with the `INCLUDELIB` directive, which simplifies linking.

Use `xlat` to translate byte index values to bytes stored in table form in memory. This can save time because looking up values in memory is usually faster than performing complex calculations. A typical use for `xlat` is to translate ASCII codes to other symbols. The instruction can also be used (often along with `lea`) to select values from two-dimensional maxtrixes.

Simplified memory models take care of many details that you must specify yourself when declaring segments “the hard way” with the `SEGMENT` directive. A typical `.EXE` program needs at least three such segments—one for data, one for code, and one for the stack. Various rules and naming conventions change the way Turbo Assembler and Linker organize your program and load segments into memory, combining some segments into units and leaving others separate.

When declaring your own segments, you must initialize segment registers, remembering always that such assignments occur at run time. Use the `ASSUME` directive, which operates at assembly time, to tell Turbo Assembler about the segment register assignments your program makes. Another related directive `GROUP` collects multiple segments of different names and, perhaps different, classes into one large segment up to 64K long.

By declaring segments with a *combine* type equal to `At`, you create a phantom segment that's overlaid on variables or code already existing in memory when your program runs. This gives you a way to read and write variables—and call or jump to procedures—that belong to other processes such as the ROM BIOS.

When you need additional space for variables, you can attach one or more far data segments to a simplified memory model. Far data segments can be initialized or uninitialized and, with an optional name after the `FARDATA` and `UFARDATA` directives, can reserve multiple chunks of 64K memory for use by even “small” memory-model programs.

The 80286 and later-model processors add several new instructions to the basic 8086 set of mnemonics. The 80386 adds even more instructions plus extended 32-bit registers, flags, and two more segment registers. Although Turbo Assembler can assemble code for these processors on any system, the results run only on computers with the appropriate hardware.

A new `VERSION` directive makes it possible to assemble programs written for all Turbo Assembler, and many Microsoft Macro Assembler, versions. `VERSION` replaces former options such as `QUIRKS`.

Use `ENUM` to create enumerated data types for a series of symbols that can be represented numerically. The symbols resemble individual numeric equates, but the assembler can guard against some kinds of errors—storing a word into a byte variable, for example.

The `SMART` directive enables the assembler to replace instructions with more efficient forms in many cases. Use `NOSMART` to turn off smart-code generation.

Other new instructions and optimizations in Turbo Assembler 4.0, as explained in this chapter, help you to write more efficient code.

Exercises

- 11.1. How many digits would there be in a hypothetical packed 4-byte BCD value?
How many digits would there be in a hypothetical unpacked 6-byte BCD value?
How many BCD digits does the `dt` directive allow you to specify in a value?
- 11.2. Write code to convert a packed BCD byte in register `al` to binary in register `ax`.
- 11.3. What `GLOBAL` directives do you need to share the following variables among multiple modules?

```
string db    'This is an ASCIIZ string,' 0
count  dw    0
BCD    dt    123456789
```

- 11.4. Using `xlat`, write code to translate a value in `c1` to the following values (equal to the cubes of 0–6):

```
c1      c1*c1*c1
-----
0       0
1       1
2       8
3       27
4       64
5       125
6       216
```

- 11.5. What does `ASSUME` do?
- 11.6. Declare a data segment named `MoreData` aligned to the next highest 256-byte page and combined with other segments of the class 'DATA'. Store a word variable named `MyWord` in your segment and show the necessary code required to load `ax` with the value of `MyWord`.
- 11.7. What does `GROUP` do? How would you use `GROUP` to refer to the four segments `SomeData`, `MoreData`, `TableSeg`, and `StringSeg`.
- 11.8. The PC `kbFlag` (keyboard flag) byte is stored at offset `017h` in the BIOS data segment at `040h`. Bit 6 of this value indicates whether the `CapsLock` key is on (1) or off (0). Write a program to display the current setting of this key. Use an absolute `At` data segment in your answer.
- 11.9. Write an 80286 interrupt service routine shell that saves and restores all general-purpose registers.
- 11.10. Write the equivalent 8086 code to duplicate the following 80386 instructions:

```
bt    dx, 3
btc   dx, 12
btr   dx, 8
bts   dx, 1
```

Projects

- 11.1. Add multiplication and division procedures to `BCD.ASM`. Hint: Unpack packed BCD variables and use `aad` and `aam` to convert values to and from binary.
- 11.2. Write `ASCIIZ` string-formatting commands to add decimal points and dollar signs and (optionally) to strip leading zeros from packed BCD values. Hint: Use the `BCDtoASCII` procedure in `BCD.ASM` to perform the raw conversion from BCD to ASCII digits, then use `STRINGS` procedures to insert and delete characters.
- 11.3. Using a PC technical reference (see Bibliography), write an include file that defines an absolute (`At`) data segment for all or most ROM BIOS variables.
- 11.4. Develop a set of macros to assemble programs with 8086, 80286, and 80386 (and later) instructions based on a conditional symbol assigned at the beginning of a module. Duplicate as many special 80286 and 80386 instructions as you can, using only 8086 instructions.
- 11.5. Hunt for program examples in this book that might be improved by assembling with special 80286 and 80386 instructions. Use your macros from Project 11.4 to reassemble the code and run time trials to test your assumptions.
- 11.6. Write a module that allows you to program various function key presses into other key strokes with the `x1at` command. Design the module so that you can reprogram the command keys in a program.

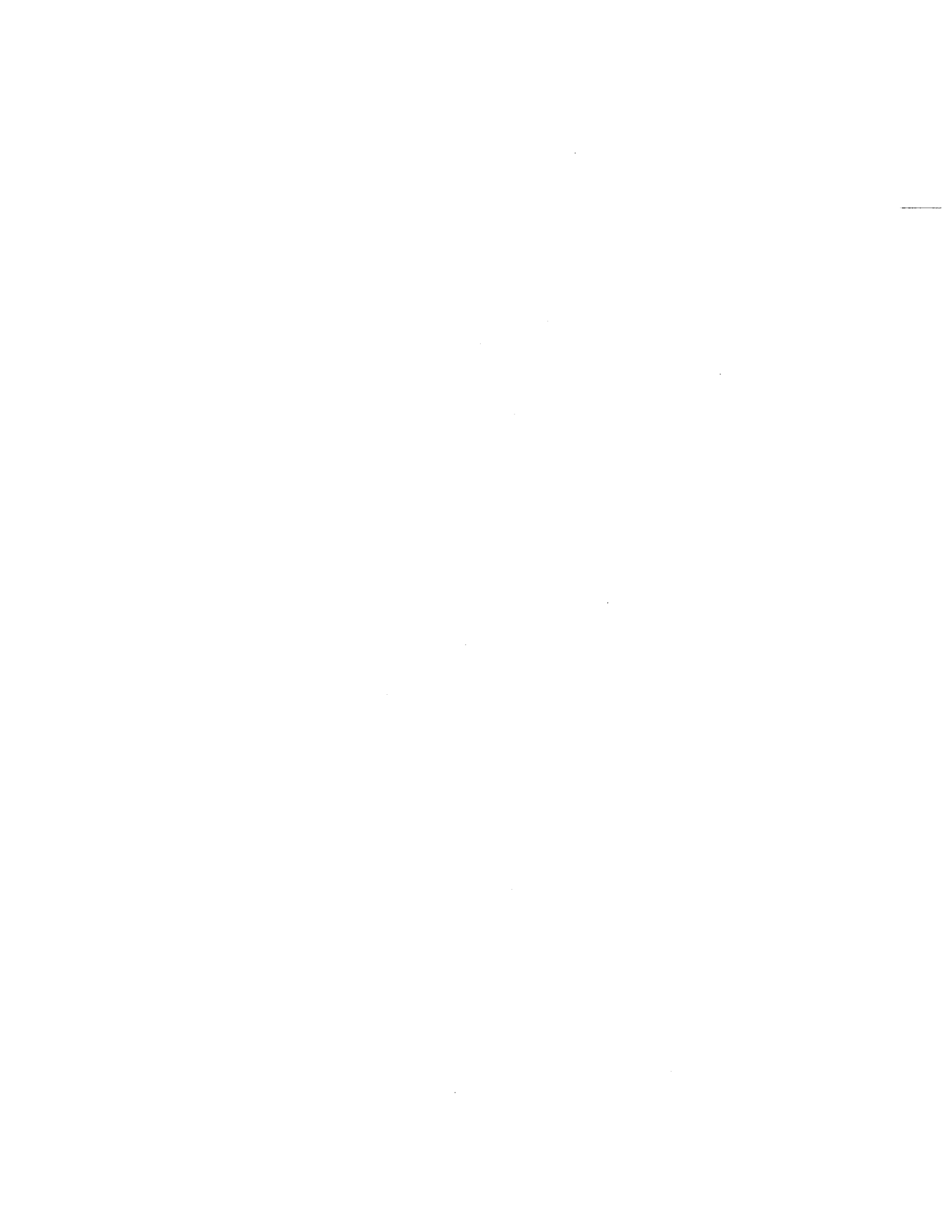



Application Programming

12

CHAPTER

Mixing Assembly Language with Pascal

- Room for Improvement, 494
- Identifying Critical Code, 495
- Converting Pascal to Assembly Language, 496
- External Procedures and Functions, 498
- The Pascal Memory Model, 499
- Calling Pascal Procedures, 502
- A (Somewhat) Crazy Example, 504
- Addressing Code-Segment Data, 508
- Addressing Typed Constants, 509
- Calling Pascal Functions, 509
- Addressing Pascal Variables, 511
- Calling External Functions, 511
- Passing Parameters, 512
- Using the TPASCAL Memory Model, 515
- Using the ARG Directive, 516
- Writing External String Functions, 517
- Going for Speed, 520
- Summary, 526
- Exercises, 527
- Projects, 529

Room for Improvement

In an ideal programming world, high-level language compilers would generate the fastest, smallest, and best machine code for any program design. If that were possible, there would be no need for this chapter—perhaps no need for this book. But it's not possible. Despite many improvements in compiler design, no high-level language is yet able to duplicate the tight, fast, clever code written by an experienced assembly language expert.

Why should this be? A probable answer is: because compilers generalize the tasks they perform. There's only one way to write a `FOR` loop in Pascal, but there are dozens of ways to implement that same `FOR` loop in assembly language. For a compiler to choose the ideal implementation method in every situation—and consider every consequence on other sections of the program—the compiler would need the intellect of a genius, the understanding of an artist, and the intuition of a fortune teller. Today's high-level language compilers are smart, but they aren't that smart.

Of all the Pascal compilers available, Turbo Pascal comes the closest to reaching the ideal. Turbo's compiled machine code runs fast, takes up little disk space, and can be used without modification in many cases. However, as good as Turbo Pascal is, there's still room for improvement, and a little assembly language sprinkled here and there can remarkably improve program speed and reduce code-file size. Also, adding assembly language to Pascal can make it easier to access hardware registers and perform other low-level tasks such as writing characters directly to video memory.

NOTE

This chapter assumes that you have some familiarity with Pascal and that you know how to install and run your compiler. You may use the sample programs in this chapter with most versions of Turbo Assembler, Turbo Pascal, and Borland Pascal.

Even more important than knowing how to add assembly language to Pascal is knowing when to do so—and when not. Always keep in mind that, by writing a portion of a program in assembly language, you'll have to rewrite that same code from scratch if you later need to transfer the program to a non-8086 computer. To reduce future headaches, it helps to follow a few simple guidelines:

- Convert only critical code to assembly language
- Write procedures and functions in Pascal first, then recode in assembly language
- Keep Pascal backup copies of converted procedures and functions so you can easily return the program to pure Pascal

Critical code refers to those sections of a program that bear more than their fair share of the total execution time. In most programs, a few procedures, functions, and loops always execute more frequently than others. Because these critical procedures account for the major share of a program's running time, rewriting the instructions in assembly language can dramatically improve a program's performance. In fact, many experts agree that most programs spend about 90% of their total operating time executing about 10% of the instructions in the entire program; therefore, a small improvement in the critical-code sections can have a major impact on program speed.

Conversely, recoding the other 90% of the instructions into assembly language may produce less dramatic results. In fact, the amount of actual improvement can be zero. For example, you probably shouldn't rewrite a simple prompt that lets someone type in a file name. People can type only so fast and, even if the code runs more efficiently, the perceived benefit will be nil. Don't waste your time rewriting sections of a program that already operate as quickly as necessary.

Identifying Critical Code

Identifying the critical 10% of a program is not always easy. In some cases, your experience with the program will tell you which sections need to be redone. For instance, you may know that a certain display is not coming on screen with the snap, crackle, and pop that you know the computer is capable of producing. In other cases, your experience with Pascal will tell you that certain operations—for example, direct access to hardware ports—will probably run faster in assembly language.

At other times the choices are not as obvious, and you may need a *profiler* program such as Turbo Profiler, which is provided with some versions of Turbo and Borland Pascal, to help locate the critical code areas. The profiler monitors a running program and builds tables of statistics to identify the instructions that execute more frequently than others. After profiling a program, you can recode these sections in assembly language, leaving the other less critical code in Pascal. This approach to program optimization helps reduce programming time and promises dramatic improvements in performance.

Even with the help of a profiler, however, it's easy to lose sight of your objective and end up revising far too much code. Remember that your aim is to identify the critical sections and then convert these sections to assembly language. While doing this, you should also be continually testing and retesting the program, observing the results of your work. You'll find the going easier if you:

- Don't profile programs that use overlays
- Do use a variety of sampling rates
- Do optimize large programs in pieces

In large programs that use overlays to conserve memory by loading independent code sections into the same areas of RAM, it's probably best to optimize the overlays as though they were individual programs. Most programmers develop large software systems by first writing the overlays as stand-alone programs rather than waste time compiling and linking other sections already completed. The final program code is constructed as one of the last steps before production. Following this approach makes optimization easier. You can simply profile the individual overlays before they are combined into the finished program. You may want to consider using this method for your next large program.

The sample rate refers to how frequently the profiler monitors a running program. The IBM PC's internal clock, ticking away at 18.2 times per second, is too slow to produce a useful profile because too many instructions are likely to execute in 1/18 second—practically an eon to a computer. For this reason, some profilers reprogram the internal clock to achieve a sampling rate of between 40 and 30,000 samples per second. Finding the correct sampling rate can be difficult; therefore, it's a good idea to profile the same program using at least three rates such as 500, 1,000, and 2,000.

Never attempt to profile and optimize a large program all at once. If your Pascal program is larger than about 10,000 lines, you'll need to devise a plan for optimizing the program one section at a time. One possibility is to profile the overlays separately. Or your profiler may allow you to insert commands into your source code to limit monitoring to specific areas.

Converting Pascal to Assembly Language

After locating the critical code in a Pascal program, you're ready to begin converting the Pascal statements to assembly language. At this point, you have three methods at your disposal.

- InLine statements
- InLine procedures and functions
- External procedures and functions

InLine statements are actually commands to the Pascal compiler to inject machine language instructions directly into the code that the compiler normally generates. Suppose, for example, that you want to disable interrupts. Because there's no Pascal statement to do this directly, an InLine statement inserts the code for the 8086 `ccli` instruction into the compiled output:

```
InLine( $FA );           { cli -- disable interrupts }
{ statements to execute with interrupts disabled }
InLine( $FB );           { sti -- enable interrupts again }
```

Usually, `InLine` statements are most useful for inserting a limited number of machine-code instructions. Because you have to use machine-code values, `InLine` statements are inconvenient for converting larger Pascal sections into assembly language.

NOTE

A good way to obtain the machine-code binary values for various instructions is to write a small assembly language program and then execute the assembled code in Turbo Debugger. Use the `View/CPU` command and copy the bytes to `InLine` statements.

The second method is to use an `InLine` procedure or function. These devices operate much like assembly language macros, inserting machine code into a program where the name of the procedure or function appears. Early in the Pascal program, you declare such procedures like this:

```
PROCEDURE ClrInt; InLine( $FA );  
PROCEDURE SetInt; InLine( $FB );
```

Functions are declared similarly. The effect is to associate the machine-code bytes in the `InLine` statements with the procedure identifiers `ClrInt` and `SetInt`. Later on, when you use these identifiers, the Pascal compiler inserts the machine code directly into the compiled code. You might, for example, use statements such as:

```
ClrInt;  
WriteLn( 'Interrupts are off' );  
SetInt;  
WriteLn( 'Interrupts are on' );
```

The advantage of this method is that it hides the machine language. Although it appears as if procedure calls are made to `ClrInt` and `SetInt`, the compiler actually inserts machine language directly into the code stream. This improves the program's portability by isolating the machine language to one place in the program source code. For another system, you can easily convert the code by replacing the `InLine` procedures with real Pascal procedures. This is far preferable to having to hunt through a program to locate all the `InLine` statements sprinkled throughout.

NOTE

The previous `InLine` examples are similar to those in my book, *Mastering Turbo Pascal*, which includes more details on using assembly language in Pascal.

External Procedures and Functions

Although it requires more organizational effort, writing external assembly language procedures and functions that you assemble separately from the Pascal source code is usually the best method. There are several reasons why this is so:

- The Pascal program retains a higher degree of portability
- External routines can be debugged separately
- External routines can be used with other languages

If you write your programs purely in Pascal and then selectively convert individual procedures and functions, you will improve your program's portability. After optimizing, if you need to transfer a program to another computer—for example, a Macintosh with a 68000 processor—it's relatively simple to replace the optimized assembly language modules with the original Pascal code that you wisely saved on disk. Then, after the program is working correctly on the new computer, you would start optimizing sections of the code in that computer's native tongue.

Another advantage of using external assembly language routines is to simplify debugging. In most cases, you can write simple test programs (either in Pascal or in assembly language) to put your code through its paces. The same code might also be usable with other languages such as C or BASIC. Many programmers build a library of such routines, ready to insert into their high-level programs.

NOTE

Subroutine calling conventions and memory models differ among languages; therefore, you can't always use the same external routines without making some changes. Even so, external assembly language code is easier to revise for this purpose than direct `InLine` injections.

Calling External Routines from Pascal

To add external assembly language procedures to Pascal, you'll need to perform these steps:

- Write a `NEAR` or `FAR` assembly language `PROC`
- Declare the `PROC PUBLIC`, exporting the external procedure's label to Pascal
- Use the `{$L <file>}` Pascal compiler command to load the assembled `.OBJ` module from disk during compilation
- Declare the procedure `EXTERNAL` in Pascal

The assembly language procedure has the same format as in other stand-alone object-code modules in this book. Be careful to declare the procedure as `NEAR` or `FAR` so that Pascal knows whether to make a long (other segment) or short (same segment) call to the procedure code. (Procedures are `NEAR` by default.) Also, so that Pascal can locate the start of the procedure code in the `.OBJ` module, you must place the procedure name in a `PUBLIC` statement. The general format is:

```
PUBLIC ProcName
PROC ProcName NEAR
;----- Code in procedure
ret ; Return to caller
ENDP ProcName
```

Change `NEAR` to `FAR` for a far (other segment) procedure. In the Pascal program, use the `{$L <file>}` compiler command to load the assembled object code during compilation. Also, declare the procedure in a Pascal `EXTERNAL` declaration, which tells the compiler the name of the procedure plus the names, numbers, and types of any parameters. In Pascal, assuming the module is named `MYCODE.OBJ`, you would use these lines:

```
{$L MYCODE.OBJ}
PROCEDURE ProcName; EXTERNAL;
```

In this example, `ProcName` has no parameters. If it did, you would declare them here. (I'll cover parameter passing later in this chapter.) After completing these steps, you're ready to call the external procedure. To do this, just use the procedure name (`ProcName` here) as a statement—exactly the way you call other Pascal procedures. You can also declare external functions, as later examples demonstrate. Upon reading the `{$L}` directive, Turbo Pascal automatically combines the external code in the `.OBJ` file into the final `.EXE` file on disk (or into memory if you are using Pascal's integrated development environment). All you have to do is compile the program—there are no extra linking steps to perform.

The Pascal Memory Model

Although the foregoing describes the necessary elements to write an external assembly language procedure for a Pascal program, one important element is missing: the format of the assembly language source text. Unfortunately, the format used in most programs in this book won't work because Pascal has its own way of organizing memory. Instead, you must use one of two different models for the Pascal compiler to be able to combine the assembled object-code file with the compiled Pascal statements.

Listing 12.1, `PASSHELL.ASM`, is a do-nothing shell that you can fill in with real code and data for your own Pascal external modules. As you can see, the shell declares data and code segments the hard way instead of using the simplified memory models of most other examples in this book. Following the listing, I'll explain why this is necessary.

Listing 12.1. PASSHELL.ASM.

```

1: %TITLE "Turbo Pascal .OBJ shell -- Copyright (c) 1989,1995 by Tom Swan"
2:
3:         IDEAL
4:
5: SEGMENT DATA word public
6:
7: ;----- Insert EXTRN data declarations here
8:
9: ;----- Insert static (uninitialized) variables here
10:
11: ENDS    DATA
12:
13:
14: SEGMENT CODE byte public
15:
16: ASSUME  cs:CODE, ds:DATA
17:
18: ;----- Insert PUBLIC code declarations here
19:
20: ;----- Insert EXTRN code declarations here
21:
22:
23: %NEWPAGE
24: ;-----
25: ; PROCEDURE ProcName( <parameters> );
26: ;-----
27: PROC    ProcName        NEAR
28:         ret                ; Return to caller
29: ENDP   ProcName
30:
31: %NEWPAGE
32: ;-----
33: ; FUNCTION FuncName( <parameters> ) : <type>;
34: ;-----
35: PROC    FuncName        NEAR
36:         ret                ; Return to caller
37: ENDP   FuncName
38:
39: ENDS    CODE
40:
41:         END                ; End of module

```

PASSHELL's DATA Segment

The PASSHELL listing declares data and code segments “the hard way,” using `SEGMENT` directives instead of selecting a simplified memory model in a `MODEL` directive. Lines 5–11 declare a public data segment—aligned to even word addresses—so that Pascal can find the segment’s beginning and end.

NOTE

Aligning the data segment on even addresses can improve access speed to 16-bit data. Specifying word alignments in the `SEGMENT` directive forces the first variable in the segment to be aligned at an even address, skipping a byte if necessary to make this happen. If you declare any byte variables in the data segment, however, you can throw the word alignment out of whack for subsequent variables. To avoid this, follow single-byte `db` directives with your own dummy-byte values, ensuring word alignment for all variables. This is necessary only in super time-critical code, however. For most programs, you can ignore the subtleties of segment alignment.

Inside the data segment, you can declare variables just as you can in any other assembly language module. There is one important difference: All variables must be *uninitialized*. In other words, these declarations will not work:

```

astring      db    15, 'A sample string'
counter      dw    100h
asciiEsc     db    27

```

Turbo Assembler accepts these declarations, but Turbo Pascal does not recognize the initialized data. This happens because the global data segment is a phantom in a compiled Pascal program, existing only when the program is executed; therefore, you can't declare preinitialized variables in the external module. Instead, you must use declarations such as:

```

astring      db    16 DUP (?)
counter      dw    ?
asciiEsc     db    ?

```

These commands allocate space for a 16-character string, a word, and a byte. When the program runs, the variables have no specific values, and it's up to you to figure out how to initialize them. Also, such variables are strictly for use in the assembly language module—you cannot export variable labels to Pascal. The reason for this restriction is that Pascal lacks an `EXTERNAL` directive that can be applied to variables. The `EXTERNAL` keyword in Pascal works only with procedures and functions. (There is a way to circumvent this problem, using a technique explained later in this chapter.)

Using Static Variables

You can get static, preinitialized variables into an assembly language module, but the method requires a little help from the Pascal compiler. Instead of using `db` and `dw` directives in the assembly language text, declare the variables in the Pascal program as *typed constants*. For example, the Pascal program might include the lines:

```

CONST  astring : string[15] = 'A sample string';
       counter : integer = $100;
       asciiEsc: byte = 27;

```

In the assembly language data segment, you can import these Pascal constants with an `EXTRN` directive, which tells Turbo Assembler that the actual addresses of the real data will be supplied later during compilation:

```
SEGMENT DATA word public
    EXTRN astring : BYTE, counter : WORD, asciiEsc : BYTE
ENDS DATA
```

You can now use `astring`, `counter`, and `asciiEsc` as though these variables were declared directly in the assembly language module. Notice that a string in Pascal is a byte pointer in assembly language. It's still up to you to figure out ways to use variables of Pascal data types such as strings, records, and sets.

PASSHELL's CODE Segment

Lines 14–39 in `PASSHELL` declare the module's `CODE` segment, aligned to any address (byte) and made `PUBLIC` for the Pascal compiler. Line 16 uses an `ASSUME` directive to inform Turbo Assembler about the relation between segment registers `cs` and `ds` and the module's segments. Pascal places no restrictions on register `es`; therefore, no declaration for this register is needed. If you plan to address the data segment with `es`, you can change line 16 to:

```
ASSUME cs:CODE, ds:DATA, es:DATA
```

Remember that the `ASSUME` directive merely tells the assembler about the module's organization—it does not generate any code or ensure that segment registers actually address specific segments. In particular, you must be careful to initialize `es`, which is not preserved between calls to internal Pascal routines. Pascal initializes `ds` to address the global data segment, of which there can be only one, up to 64K long. Consequently, you do not have to initialize `ds` in your module's code.

NOTE

Pascal takes care of allocating space for the stack. Never declare stack space or reassign `ss` in your external modules.

Calling Pascal Procedures

Line 18 shows where to insert `PUBLIC` declarations. After the keyword `PUBLIC` insert the names of all the procedures in the module that you want to export to Pascal. You don't have to list every procedure. For example, a module can have local subroutines for the private use of other procedures inside the module. But every name in the `PUBLIC` declaration must have a corresponding `EXTERNAL` procedure or function declaration in the Pascal text. Also, remember that only code, not data, can be declared `public`.

Line 20 shows where to insert `EXTRN` declarations. These refer to Pascal procedures and functions that you want to call from within your assembly language code. For example, suppose you have a Pascal routine named `Pause`, which displays a message and waits for you to press the Enter key:

```
PROCEDURE Pause;
BEGIN
  WriteLn;
  Write( 'Press <Enter> to continue...' );
  ReadLn
END; { Pause }
```

To export `Pause` from Pascal to an assembly language module, you must be sure that the Pascal compiler knows the name of the procedure before it loads the assembled object code. One way to do this is to declare `Pause` `FORWARD` *before* the `{$L <file>}` directive that loads the file from disk. If the assembly language module is named `ANYCODE.OBJ`, you could use these Pascal statements near the beginning of the program:

```
PROCEDURE Pause; FORWARD;
{$L ANYCODE.OBJ}
```

To call `Pause` from within the external assembly language module, construct the `CODE` segment something like this:

```
SEGMENT CODE byte public
ASSUME cs:CODE, ds:DATA
EXTRN  Pause:NEAR
PROC   MyProc NEAR
      call  Pause          ; Call Pascal procedure
      ret
ENDP   MyProc
ENDS
```

The `EXTRN` directive tells Turbo Assembler that `Pause` is a near procedure (in the same code segment). If this is not so—for example, if in the Pascal text you used the `{$F+}` directive to turn on far-code generation or if the procedure is listed in the interface section of a unit—then you must declare `Pause` as `FAR`. The actual call to `Pause` is no different than calls to other assembly language subroutines. In this example, however, there are no parameters. If there were, you'd also have to pass the parameters in the exact way expected by the Pascal code—a subject we'll tackle in a moment.

The Code-Segment Body

Lines 24–37 in `PASSHELL` list empty shells for external procedures and functions. The only difference between a procedure and a function is that a function returns a value—a procedure does not. (In Pascal, functions are used in expressions, while procedures are called by name in statements.)

The final section in PASSHELL appears at lines 39–41. Because a simplified memory model is not used, the CODE segment must be terminated with an ENDS directive (line 39). The END at line 41 tells the assembler that this is the last line of the source text. You may not specify an entry point label after END, as you do for stand-alone assembly language .EXE programs.

A (Somewhat) Crazy Example

Listing 12.2, PASDEMO.ASM, and Listing 12.3, PASDEMO.PAS, will help answer many questions about how to pass code and data back and forth among Pascal and assembly language modules. The example is a little “crazy”—it doesn’t perform any useful actions other than to demonstrate various subjects (discussed after the listings). Except for parameter passing, the program illustrates almost every combination of sharing code and data and will serve as a useful guide for your own projects. To assemble and compile the test, use these commands:

```
tasm /zi pasdemo
tpc /v pasdemo
```

If you have Borland Pascal, replace tpc with bpc. Do the same for all instructions in this chapter that refer to tpc. For these commands to work, you must have installed the command-line compiler.

The options /zi and /v add debugging information to PASDEMO.EXE so that Turbo Debugger can show you both the Pascal and assembly language source-code lines along with the assembled and compiled machine code. Another choice is to create a file named MAKEFILE containing these lines:

```
pasdemo.exe: pasdemo.obj pasdemo.pas
    tpc /v pasdemo
```

```
pasdemo.obj: pasdemo.asm
    tasm /zi pasdemo
```

With this text stored on disk in a file named MAKEFILE, type **make** to create PASDEMO.EXE. (If you name MAKEFILE something else, MAKEPAS.MAK for example, type **make -fmakepas.mak** to create PASDEMO.EXE.) The MAKEFILE statements declare that PASDEMO.EXE depends on (is created from) PASDEMO.OBJ and PASDEMO.PAS. If either of these two files changes, then the tpc command compiles the Pascal program, combining this code with the assembled object code. The second part of MAKEFILE states that PASDEMO.OBJ depends on PASDEMO.ASM. If this file changes, then Turbo Assembler assembles PASDEMO.ASM, creating PASDEMO.OBJ (which also causes PASDEMO.PAS to be recompiled).

Listing 12.2. PASDEMO.ASM.

```

1: %TITLE "Test Pascal .OBJ module -- Copyright (c) 1989,1995 by Tom Swan"
2:
3:     IDEAL
4:
5: ;----- Data segment combines with Pascal's global data segment
6:
7: SEGMENT DATA word public
8:
9: ;----- Import typed constants and variables from Pascal
10:    EXTRN  value : WORD, cr : BYTE, lf : BYTE
11:
12: asmCount      dw      ?      ; Static variable
13:
14: ENDS    DATA
15:
16:
17: ;----- Code segment combines with Pascal's main program
18:
19: SEGMENT CODE byte public
20:
21: ASSUME  cs:CODE, ds:DATA      ; Explain memory model to assembler
22:
23: ;----- Export public procedures to Pascal
24:    PUBLIC  AsmProc, CountPtr
25:
26: ;----- Import procedures and functions from Pascal
27:    EXTRN  PasProc : NEAR, PasFunc : NEAR
28:
29:
30: ;-----
31: ;  PROCEDURE AsmProc;
32: ;-----
33:
34: ;----- Preinitialized variables must go in the code segment
35: testString    db      'AsmProc: Should be a "hatch mark" --> ', '$'
36:
37: PROC    AsmProc NEAR
38:
39: ;----- Call a Pascal procedure
40:
41:    call    PasProc          ; pasProc is in PASDEMO.PAS
42:
43: ;----- Use local data stored in the code segment
44:
45:    push    ds              ; Save Pascal's ds register
46:    push    cs              ; Address code segment with
47:    pop     ds              ; register ds
48: ASSUME  ds : CODE        ; Inform assembler
49:    mov     dx, offset testString ; Address the test string
50:    mov     ah, 09h        ; Display the test string by
51:    int     21h           ; calling DOS function 9
52:    pop     ds              ; Restore Pascal's ds register
53: ASSUME  ds : DATA        ; Inform assembler
54:
55:

```

Listing 12.2.continued

```

56: ;----- Get typed-constants from Pascal and use local static variables
57:
58:     mov     ax, [value]           ; Get value from Pascal
59:     mov     [asmCount], ax       ; Initialize static variable
60:
61:
62: ;----- Call a Pascal function for a character value
63:
64:     call    PasFunc              ; Get test char from Pascal
65:     mov     dl, al                ; Assign char to dl
66:     mov     ah, 2                 ; Display char with DOS
67:     int     21h                  ; function 2
68:
69:
70: ;----- Get variables from Pascal
71:
72:     mov     ah, 2                 ; DOS display-char function
73:     mov     dl, [cr]             ; Get cr from Pascal
74:     int     21h                  ; Perform carriage return
75:     mov     dl, [lf]            ; Get lf from Pascal
76:     int     21h                  ; Perform line feed
77:     ret                             ; Return to caller
78:
79: ENDP     AsmProc
80:
81:
82: %NEWPAGE
83: ;-----
84: ; FUNCTION CountPtr : intPtr;
85: ;-----
86: PROC     CountPtr              NEAR
87:     mov     dx, SEG asmCount     ; Pass segment address in dx
88:     mov     ax, OFFSET asmCount ; Pass offset address in ax
89:     ret                             ; Return to caller
90: ENDP     CountPtr
91:
92: ENDS     CODE                  ; End of code segment
93:
94:     END                          ; End of module

```

Listing 12.3. PASDEMO.PAS.

```

1: { Test program, to be linked to externals in PASDEMO.OBJ }
2:
3: {$D+}    { Include debugging information }
4:
5: PROGRAM PasDemo;
6:
7: CONST
8:   value: Integer = 1234; { Typed-constant declaration }
9:

```

```

10: TYPE
11:   IntPtr = ^Integer;      { Pointer to integer type }
12:
13: VAR
14:   cr, lf : Char;          { Global variables }
15:
16: PROCEDURE PasProc; FORWARD;      { Must come before $L directive }
17: FUNCTION PasFunc: Char; FORWARD;
18:
19: {$L PASDEMO.OBJ}                { Load the assembled object code }
20:
21: { External declarations, telling Pascal the format of the
22: external routines in PASDEMO.ASM. }
23:
24: PROCEDURE AsmProc; EXTERNAL;
25: FUNCTION CountPtr: IntPtr; EXTERNAL;
26:
27: PROCEDURE PasProc;
28: VAR I: Integer;              { Can't be exported to ASM module }
29: BEGIN
30:   Writeln('PasProc: Inside the Pascal procedure')
31: END; { PasProc }
32:
33: FUNCTION PasFunc: Char;
34: BEGIN
35:   PasFunc := '#'            { Pass a character to ASM module }
36: END; { PasFunc }
37:
38: BEGIN
39:   cr := chr(13);
40:   lf := chr(10);
41:   AsmProc;
42:   Writeln('Main: asmCount = ', countPtr^)
43: END.

```

NOTE

In the following sections, line numbers prefaced with "p" refer to PASDEMO.PAS, while those prefaced with "a" refer to PASDEMO.ASM.

Understanding PASDEMO

Lines a7–14 declare the assembly language module's data segment. An `EXTRN` directive imports one variable constant `value` and two variables `cr` and `lf` from the Pascal code (see lines p8, p14). Notice that the Pascal program does not have to export variables and variable constants but that the assembly language module must import these items to make the names available to assembly language instructions.

Line a12 declares a static uninitialized variable. The question mark must be used here because initialized variables are not permitted in external code.

The `PUBLIC` directive at line a24 exports `AsmProc` and `countPtr` assembly language modules (see lines a30–90) to Pascal. Lines p24–25 correspondingly declare these two routines `EXTERNAL`, allowing calls to this code from within the Pascal program. Notice how line p25 specifies the function result type, which is declared as a Pascal data type (a pointer to an integer) back at line p11.

Another `EXTRN` directive, this time in the code segment at line a27, imports a Pascal procedure `PasProc` and a function `PasFunc` into the assembly language module. This code is called at lines a41 and a64, illustrating how to call Pascal routines from external assembly language modules. The `NEAR` qualifiers in the `EXTRN` directive (line a27) tell the assembler that this code is in the same segment. `FAR` qualifiers would be necessary if the Pascal routines were compiled with the `{$F+}` directive or if they appear in the interface section of a unit. In the Pascal text, `PasProc` and `PasFunc` are declared `FORWARD` (see lines p16–17), making these identifiers known to the compiler before the `{$L}` command at line p19, which loads the assembled object code from disk. The Pascal code for this routine appears at lines p27–36.

Addressing Code-Segment Data

Although you can't declare initialized variables in the data segment of an assembly language module to be linked to Pascal, you can insert data into the code segment as shown at line a35 in `PASDEMO.ASM`. Be careful to separate code and data, preferably placing the variables outside of your `PROC` directives.

NOTE

The main code segment in a compiled Pascal program is limited to 64K and includes the main program body plus all global procedures and functions, so it's best to keep the number and size of initialized variables here to a minimum.

Addressing variables in the code segment requires using a code-segment override (`cs:`) in the memory reference. More difficult is passing the address of such variables to other routines, especially to DOS function calls, demonstrated here at lines a45–53. First, the current `ds` register is saved on the stack. This is vital. Pascal requires `ds` to point to the global data segment at all times. If you change `ds` in the assembly language module and forget to restore the register's original value before returning to Pascal, the program will almost surely suffer a horrendous crash.

NOTE

Despite this dire warning about changing `ds`, you may change `es` at any time. Pascal makes no assumptions about the segment addressed by `es`. However, you should not assume that `es` will retain its value between calls to external subroutines.

Lines a46–47 set `ds` equal to `cs`, addressing the code segment with the data-segment register. Because of this, it's a good idea to use an `ASSUME` directive (line a48) to tell Turbo Assembler about the change to `ds`. After these steps, lines a49–51 call DOS function 9 to display an ASCII\$ string. Then, line a52 restores Pascal's `ds` segment register value, requiring another `ASSUME` (line a53) to inform Turbo Assembler that `ds` again addresses the DATA segment.

Addressing Typed Constants

Lines a58–59 in PASDEMO.ASM initialize the global `asmCount` variable, declared at line a12. First, the typed constant value (see line p8) in the Pascal text is moved into register `ax` (line a58). Turbo Assembler knows that `value` addresses a 16-bit word because of the `EXTRN` declaration at line a10. As this illustrates, it's up to you to ensure that your `EXTRN` directives specify the correct data types for variables declared in Pascal. If you declared `value` to be type `byte`, Turbo Assembler has no way of knowing that this is wrong.

Line a59 assigns the value in `ax` to the `asmCount` uninitialized static variable stored in the data segment. As you can see from this example, there's no indication in the program (lines a58–59) about where the variables are declared. You can read and write variables (and variable constants) the same way whether they are declared in the assembly language module or in the Pascal text.

NOTE

Unlike variables and typed constants, you can't export `CONST` and `TYPE` declarations from Pascal to assembly language. Plain constants and data-type identifiers can be used only in the Pascal program.

Calling Pascal Functions

Calling Pascal functions from within an assembly language module is similar to calling Pascal procedures. After calling `PasFunc` (line a64), the value returned in `ax` by the function is assigned to register `d1`. Because `PasFunc` returns a character, only the low half of `ax` is needed. This character is then displayed using DOS function 2.

NOTE

It's your responsibility to use function values appropriately in the assembly language module and to know which registers are affected by calling Pascal functions. Table 12.1 (copied in part from *Mastering Turbo Pascal*) lists function result sizes and the registers used to return values of these types.

Table 12.1. Pascal Function Types and Sizes.

<i>Function Type</i>	<i>Size in Bytes</i>	<i>Register(s)</i>
Boolean	1	al
Char	1	al
Enumerated (8-bit)	1	al
Enumerated (16-bit)	2	ax
ShortInt	1	al
Byte	1	al
Integer	2	ax
Word	2	ax
LongInt	4	dx = high, ax = low words
Single	See note 1	
Double	See note 1	
Real words	6	dx = high, bx = mid, ax = low
Extended	See note 1	
Comp	See note 1	
Pointer	4	dx = segment, ax = offset
String	See note 2	

Note 1. These function types are returned in the math coprocessor top-of-stack register.

Note 2. String functions receive a pointer to a temporary work space created by the caller to the function. The function stores characters at this address, returning the pointer undisturbed on the stack.

Addressing Pascal Variables

Lines a72–76 execute a carriage return and line feed, passing to DOS function 2 the values of two Pascal variables `cr` and `lf`, which are declared at line p14 and initialized in Pascal at lines p39–40. (If you think this is an odd way to start a new display line, you're right. Even so, the code illustrates how to pass data from Pascal to an external module.) Notice that these variables are imported into the assembly language module as bytes in the `EXTRN` declaration at line a10. The variables (and typed constants) are stored in Pascal's global data segment and, therefore, are easily accessed as shown here.

NOTE

Variables local to Pascal procedures and functions—for example, the integer variable `i` at line p28—cannot be accessed from inside an assembly language module. Local variables in Pascal exist only while the declaring procedures or functions are active; therefore, you cannot tell Turbo Assembler where these variables will be in memory until the program runs. To get around this restriction, you must pass local variables by value or by address as parameters to external procedures and functions.

Calling External Functions

Lines a83–90 implement a small external function that demonstrates several additional concerns. The function name is made public (line a24) and declared as an `EXTERNAL` function in the Pascal text (line p25). The data type for this function is a pointer to type `integer`, defined as `IntPtr` in the Pascal program at line p11. The assembly language module can't use this data type directly, and the program has to return values in the proper registers expected by Pascal for this and other function types. Turbo Assembler can't check the correctness of external function results.

In this case, because the type is a pointer, Pascal expects `dx` to hold the segment and `ax` the offset values of the address (see Table 12.1 and lines a87–88). In the Pascal code, line p42 uses this address by dereferencing the function identifier, displaying an integer value in a `WriteLn` statement. But what is this value? Looking again at the assembly language code, you can see that lines a87–88 assign the address of the `asmCount` uninitialized variable, declared in the data segment at line a12. The `SEG` operator returns the segment value of the label's address. The `OFFSET` operator returns the offset value. Together, the two values exactly locate `asmCount` in memory, displaying the value of this variable in the `WriteLn` statement. This demonstrates how to pass external variables to Pascal. Remember, a `PUBLIC` declaration for data labels is accepted by Turbo Assembler but rejected by Turbo Pascal because, except for variable constants, the Pascal data segment doesn't exist until the program runs. Passing the address of a variable to Pascal is required to transfer variables from external modules to Pascal programs.

NOTE

You can also pass pointers as procedure and function parameters, as the next section explains. However, using pointer functions to locate variables declared in assembly language modules is usually the best approach because of the additional programming required to manipulate procedure and function parameters.

Passing Parameters

External assembly language routines become more complicated when variable and value parameters are added. There are many issues involved: whether the parameters are passed by value or by reference; how to handle special cases such as strings and arrays; how to ensure that the stack is correctly configured for return to Pascal; and how to perform all of this in reverse—that is, when passing parameters from inside the assembly language module to Pascal procedures and functions.

The best way through this thicket of details is to have a thorough understanding of Pascal programming and to have a good grasp on how the Pascal compiler implements procedures and functions in machine code. Don't forget that you have one of the world's best teachers at your disposal—Turbo Debugger. Examining test Pascal programs at the machine-code level with the `view:CPU` command is a great way to learn how Pascal implements statements in machine code.

Value Parameters

Value parameters are passed as simple variables on the stack. For example, to pass an integer parameter, Pascal pushes the value of the parameter onto the stack before calling the procedure that requires that value. A Pascal procedure such as:

```
PROCEDURE Count( I : Integer );
```

would be called in machine language with instructions similar to:

```
mov    ax, [I]          ; Get value of I
push   ax               ; Push I's value onto the stack
call   Count           ; Call procedure
```

The compiled code for the `Count` procedure has to retrieve the value of `I` from the stack. In Pascal, procedures and functions do this by referencing the stack with register `bp`. Consequently, compiled procedures and functions normally begin with:

```
push   bp              ; Save current bp value
mov    bp, sp          ; Address stack with bp
```

Figure 12.1 illustrates the stack at the start of `Count` after these two instructions execute. The value of `I` is under the 2-byte return address, which is in turn under the saved value of `bp`. (Each numbered box in this diagram represents one byte. The numbers do not represent real addresses in memory, though.)

Figure 12.1.
Stack showing one Pascal value parameter.

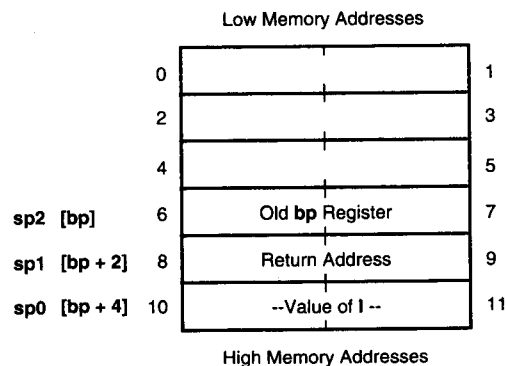

Counting from `bp` to the start of `I`, you can see that adding 4 to `bp` finds the start of `I`. Therefore, to load `ax` with the value stored at this location on the stack, you can write:

```
mov ax, [word bp + 4] ; Assign I's value to ax
```

You can also refer to values directly with instructions such as:

```
inc [word bp + 4] ; I := I + 1
```

One complication with this arises in `FAR` procedures. In these routines, the return address is 4 bytes long, having both segment and offset parts. (See Figure 12.2.) Therefore, to load the value of `I`, use the correct offset 6, instead of 4:

```
mov ax, [word bp + 6] ; Load I into ax (FAR routine)
```

Figure 12.2.
Stack after calling a FAR procedure with one value parameter.

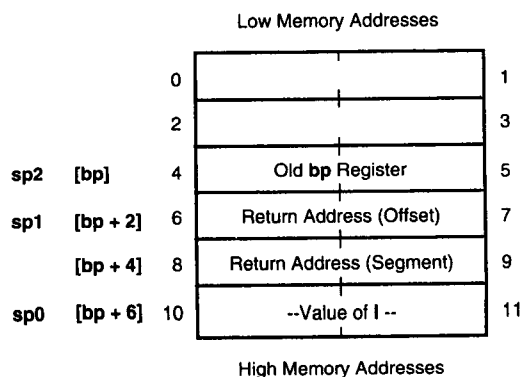

Returning from External Code

When the external assembly language routine ends, it must use a special form of the `ret` instruction to remove the parameter bytes from the stack in addition to `ret`'s normal duty of popping the return address and continuing the program after the `call` that activated the routine. In this case, there are two parameter bytes on the stack; therefore, the routine would end with:

```
ret     2                ; Return and pop 2 bytes from stack
```

The optional immediate value following `ret` is added to the stack pointer *after* popping the return address into `ip` (and `cs` in the case of an intersegment `FAR` call). Remember that the intermediate value represents the number of *bytes* of all parameters passed on the stack. Because Pascal never pushes a value less than 2 bytes long—even single-byte characters are passed as 2-byte words—the optional `ret` value in Pascal external routines should always be an even number.

Variable Parameters

Variable parameters—those prefaced with `VAR` in the Pascal procedure or function parameter list—are passed by reference, that is, by address. The 4-byte address of each such variable is passed on the stack and referenced just like any other value. The assembly language code can use the address as a pointer to the actual value somewhere else in memory. This is easier to see with a few examples. Suppose the previous procedure declares a variable parameter:

```
PROCEDURE Count( VAR I : Integer );
```

In the compiled code, the caller to the `Count` procedure pushes the address of `I` onto the stack. Assuming `I` is stored in the program's data segment, the compiled instructions might be similar to:

```
mov     di, offset I      ; Get offset of variable I
push   ds                ; Push segment address of I
push   di                ; Push offset address of I
call   Count             ; Call Count procedure
```

At the start of `Count`, after saving and assigning to `bp` the stack-pointer register, the stack appears as in Figure 12.3. With the stack configured as in this figure, you can get the value of `I` into the assembly language module in several ways. One possibility is to load `es` and another register (`di` is a good choice as is `bx`) from the stack:

```
mov     es, [word bp + 6] ; Get segment value
mov     di, [word bp + 4] ; Get offset value
```

After doing this, `es:di` addresses the value of `I` in memory. Be aware that this location could be anywhere—in a data segment or, perhaps, in a stack segment if, for example, `I` is a local variable declared in a Pascal procedure or function. Another way to accomplish the same result is to use the `les` instruction:

```
les    di, [bp + 4]      ; Load es:di with address of I
mov    ax, [word es:di] ; Load value of I into ax
```

Figure 12.3.
Stack with one variable parameter.

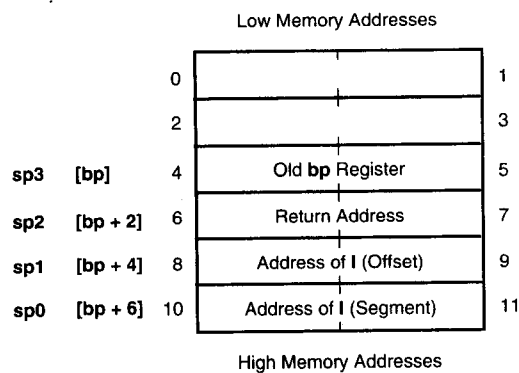

The `les` instruction loads both `es` and `di` (or another general purpose register) with the address stored at the specified location, here 4 bytes in advance of where `ss:bp` points. The second instruction then addresses this location to load the value of the variable parameter into `ax`. A similar instruction `lds` can be used to load the segment portion of an address into `ds`. Because Pascal needs `ds` to address the global data segment, if you use `lds`, be sure to save and restore the original value of `ds` before your external routine ends.

Using the TPASCAL Memory Model

One way to simplify addressing variables on the stack is to use a special Turbo Assembler memory model `TPASCAL`, designed for use with early versions of Turbo Pascal. You do not have to use `TPASCAL` with Borland Pascal. The advantages of this method are:

- You can use simplified `CODESEG` and `DATASEG` directives instead of declaring named segments manually.
- Turbo Assembler automatically prepares and restores the `bp` register for you.
- Parameter addresses on the stack are precalculated, allowing you to address parameters by name rather than computing stack offsets, for example, as in `[bp + 8]`.
- The correct immediate value is added automatically to the `ret` instruction to remove parameter bytes from the stack.

A disadvantage of the `TPASCAL` memory model is the inability to prevent Turbo Assembler from generating instructions to prepare `bp` for addressing stack variables. Even in procedures that have no parameters, these instructions are blindly inserted. One of the reasons for adding assembly language to Pascal in the first place is to strip every unnecessary instruction, honing your code to a fine edge. Using `TPASCAL` is convenient in some cases—as in the following examples. But, for the ultimate in low-level control, you must declare `SEGMENT` directives manually as in `PASHELL.ASM`.

Using the ARG Directive

With the TPASCAL memory model in effect, you can use an ARG directive to simplify parameter addressing. ARG tells Turbo Assembler the names and sizes of parameters passed to external PROCs on the stack. The assembler uses this information to calculate the offset values relative to `ss:bp` where the parameter values are stored.

NOTE

ARG works with other memory models and with nonsimplified segments, too. However, there is a difference. With the TPASCAL memory model, parameters must appear in ARG directives in the same order they appear in Pascal procedure and function declarations. When not using TPASCAL, you must list parameters in the reverse order.

ARG requires a series of elements separated by commas, with each element describing one parameter. For example, this Pascal procedure declaration:

```
PROCEDURE StoreNum( MyNumber : Integer );
```

has the corresponding PROC declaration:

```
PROC      StoreNum      NEAR
          ARG MyNumber:WORD
```

After executing this, move the value of `MyNumber` into a register using assembly language instructions such as:

```
mov      ax, [MyNumber]          ; Load ax with value of MyNumber
```

Contrast this with the usual method of addressing stack variables relative to `bp`:

```
mov      ax, [word bp + 4]
```

If you later change the number of parameters passed to the procedure—or if you change the procedure type from NEAR to FAR—reassemble the external object-code module to adjust the location of `MyNumber` on the stack. Without an ARG directive, you must recalculate and change the literal 4 manually, greatly increasing the chances of introducing a bug if you make a mistake.

Deallocating Stacked Parameters

If you follow an ARG parameter list with an equal sign = and a temporary name, Turbo Assembler calculates the number of bytes occupied by all parameters and assigns this value to the name you supply. For example, the following sets `ArgSize` to the number of bytes occupied by the two parameters, `his` and `hers`:

```
PROC      Share          NEAR
          ARG his:WORD, hers:WORD =ArgSize
```

When not using the TPASCAL memory model, you can use `ArgSize` with `ret` to remove parameter bytes from the stack:

```
ret      ArgSize          ; Return and deallocate stack parameters
```

Don't do this when using the TPASCAL memory model, in which case Turbo Assembler automatically adds the correct value to `ret` (assuming you specified the correct number and sizes of parameters in an `ARG` directive). When using the TPASCAL memory model, always end your external `PROC`s with a plain `ret` instruction. (You can still add `=ArgSize` to the `ARG` directive and use the value equated to `ArgSize` in other ways.)

Writing External String Functions

A third option lets you specify parameters that are not to be removed from the stack when your external routine ends. To do this, follow the element list (plus an optional `=ArgSize` command) with `RETURNS`, in turn followed by a list of parameters that should remain on the stack when the `PROC` ends.

In Pascal, the only time you'll probably need `RETURNS` is when writing external string functions. When Pascal calls a string function, it first pushes the function result—a 4-byte pointer—onto the stack before pushing other parameters (if there are any) passed to the function. The function result pointer addresses a temporary area where your external code can store the characters of the string returned by the function. When the external routine ends, Pascal expects the string function pointer to remain on the stack. (Instructions following the subroutine call later remove these bytes or just pass the address to another procedure or function that uses the function's string result.) Because of this special action, if you declare the function result in the `ARG`'s main parameter list, the procedure will not work because Turbo Assembler deallocates the parameter bytes plus the function result pointer at the `ret` instruction.

Listing 12.4, `FILLSTR.ASM`, demonstrates the correct way to write an external Pascal string function. Listing 12.5, `FILLSTR.PAS`, shows how to link the external module to a Pascal program. Assemble, compile, and run the Pascal test with the commands:

```
tasm fillstr
tpc fillstr
fillstr
```

Listing 12.4. FILLSTR.ASM.

```

1: %TITLE "Pascal String-Filler Function -- Copyright (c) 1989,1995 by Tom Swan"
2:
3:     IDEAL
4:
5:     MODEL    TPASCAL
6:
7:     CODESEG
8:
9:     PUBLIC FillString
10:
11: %NEWPAGE
12: ;-----
13: ; FUNCTION FillString( n : Byte; ch : Char ) : String;
14: ;-----
15: PROC    FillString    NEAR
16:     ARG n:BYTE:2, c:BYTE:2 RETURNS string:dWORD
17:
18:     les    di, [string]    ; es:di addresses fn result
19:     mov    al, [n]        ; Load n into al
20:     cld                    ; Auto-increment di
21:     stosb                   ; Initialize string length
22:     xor    ch, ch         ; Zero upper half of cx
23:     mov    cl, al         ; cx = requested string len
24:     mov    al, [c]        ; al = fill character
25:     jcxz   @@99           ; Exit if length = 0
26:     repnz  stosb          ; Store cx chars in string
27: @@99:
28:     ret                    ; Return to caller
29: ENDP    FillString
30:
31:     END                    ; End of module

```

Listing 12.5. FILLSTR.PAS.

```

1: PROGRAM FillStr;
2:
3: { Test using the FillString external function }
4:
5: VAR    s : String;
6:
7: FUNCTION FillString( n : Byte; ch : Char ) : String; EXTERNAL;
8: {$L FILLSTR.OBJ}
9:
10: BEGIN
11:     s := FillString( 45, '@' );
12:     WriteLn( 'After filling: ', s )
13: END.

```

How FILLSTR Works

Line 16 in FILLSTR.ASM constructs an ARG declaration to return a parameter on the stack. For reference, this line is repeated below:

```
ARG n:BYTE:2, c:BYTE:2 RETURNS string:dword
```

First come the two parameters *n* and *c*, each of which are single bytes. Notice that the *ch*:char parameter from the Pascal text is renamed *c* here because *ch* in assembly language refers to the high byte of register *cx* and can't be used for an identifier. (I purposely contrived this conflict to illustrate that, in the ARG declaration, parameter names can be anything you like—they don't have to mirror their Pascal counterparts.)

Because Pascal always pushes values onto the stack in multiples of 2 bytes, an additional qualifier `:2` is added to the two parameters, telling Turbo Assembler that, even though it should address *n* and *c* as bytes, it should consider these variables to occupy 2 bytes of stack space. If you don't include the `:2`, Turbo Assembler will miscalculate the number of bytes occupied by the parameters and will not correctly fix up the stack when the external routine ends.

NOTE

The symptom of an incorrect stack deallocation is a "Stack Overflow" error. If you receive this error, check that all single-byte parameters have a `:2` specification in your ARG lists.

Following the two parameters is the phrase `RETURNS string:dword`. The name *string* can be any identifier, which simply gives you a way to refer to the function result inside the external code. The `:dword` part of this directive tells Turbo Assembler that *string* addresses a 4-byte value on the stack. (A string function actually returns a pointer in Turbo Pascal, and pointers are always 4 bytes.)

You can address the string function result in various ways. The easiest method is to load `es:di` or `ds:si` with the address of the area reserved for the result:

```
les    di, [string]    ; es:di addresses function result
```

After this, the string's length byte is located at `es:di`. The first character of the string is at `es:di + 1`, and so on. Storing characters at `es:di` passes those characters back as the string function result. You don't have to perform any other steps to return the string to the caller to the external function. In `FILLSTR.ASM`, a repeated `stosb` instruction uses these methods to return a string filled with *n* characters of any ASCII value.

Declaring Parameters Without ARG

There's another way to declare parameters that doesn't use ARG—just place the parameter list after the `PROC` and `NEAR` or `FAR` directive. For example, you can replace lines 15–16 in `FILLSTR.ASM` with:

```
PROC FillString NEAR n:BYTE:2, c:BYTE:2 RETURNS string:dword
```

In other words, if you write everything on one line, you don't need an `ARG` directive. But because long `PROC` declarations such as this can be confusing to read, I prefer to list arguments in a separate `ARG` directive. The results are identical, however, and you can use whichever method you like.

Going for Speed

Let's face it. There's only one reason to spend time optimizing Pascal or any other language with system-dependent assembly language: to achieve the blinding speed that, when used well, only assembly language promises. In this section, you'll write a Pascal program, take apart the machine code generated by Turbo Pascal, and write highly optimized replacement external code in assembly language. As you'll see, the results are worth the effort.

The Pascal Program

First, we need a Pascal program. Listing 12.6, `STR.PAS`, contains two useful procedures, `ASCIIZtoStr` and `StrToASCIIZ`, which convert Pascal strings to and from the `ASCIIZ` format used by many assembly language programs in this book. To save space here, the optimized version of the Pascal code is listed. For test purposes, therefore, after you enter this program, copy `STR.PAS` to another file named `STRSLOW.PAS` (both files are provided on disk).

Next, load `STRSLOW.PAS` into your editor and delete lines 12, 18–19, 30, 36–37, and 45. The lines are already deleted if you are using the supplied disk files. This converts the listing to pure Pascal, eliminating the references to the external routines that you'll add back later. After making the modifications, compile `STRSLOW` with the command:

```
tpc /v strslow
```

Listing 12.6. `STR.PAS`.

```
1: PROGRAM StringConversion;
2:
3: { Convert ASCIIZ strings and Pascal strings }
4:
5: TYPE  ASCIIZString = ARRAY[ 0 .. 255 ] OF Char;
6:       ASCIIZptr   = ^ASCIIZString;
7:
8: VAR   a : ASCIIZString;
9:       s : String;
10:
11:
12: {$L STR.OBJ}
13:
14:
```

```
15: { Convert an ASCIIZ string (a) to a Pascal string (s) }
16:
17: PROCEDURE ASCIIZtoStr( a : ASCIIZString; VAR s : String );
18:   EXTERNAL;
19: (*
20: VAR Len : Integer;
21: BEGIN
22:   Len := 0;
23:   WHILE ( Len < 255 ) AND ( a[ Len ] <> Chr( 0 ) ) DO
24:     BEGIN
25:       Len := Len + 1;
26:       s[ Len ] := a[ Len - 1 ]
27:     END; { while }
28:   s[ 0 ] := Chr( Len )
29: END; { ASCIIZtoStr }
30: *)
31:
32:
33: { Convert a Pascal string (s) to an ASCIIZ string (a) }
34:
35: PROCEDURE StrToASCIIZ( s : String; VAR a : ASCIIZString );
36:   EXTERNAL;
37: (*
38: VAR Len, I : Integer;
39: BEGIN
40:   Len := Length( s );
41:   FOR I := 1 TO Len DO
42:     a[ I - 1 ] := s[ I ];
43:   a[ Len ] := Chr( 0 )
44: END; { StrToASCIIZ }
45: *)
46:
47:
48: { Display an ASCIIZ string }
49:
50: PROCEDURE ShowASCIIZ( a : ASCIIZString );
51: VAR I : Integer;
52: BEGIN
53:   I := 0;
54:   WHILE ( I < 255 ) AND ( a[ I ] <> Chr(0) ) DO
55:     BEGIN
56:       Write( a[ I ] );
57:       I := I + 1
58:     END { while }
59: END; { ShowASCIIZ }
60:
61:
62: BEGIN
63:   s := 'This is a test';
64:   StrtoASCIIZ( s, a );
65:   ShowASCIIZ( a );
66:   Writeln;
67:   s := '';
68:   ASCIIZtoStr( a, s );
69:   Writeln( s )
70: END.
```

Examining STRSLOW's Code

After compiling STRSLOW, to see the machine code produced by Turbo Pascal, run the program under control of Turbo Debugger with the command:

```
td strslow
```

Then, press F7 repeatedly to step through the program. When you get inside the `StrToASCIIz` and `ASCIIzToStr` procedures, use the `View!CPU` command to look at the machine code that Turbo Pascal generates for these routines. You may be amazed at the lengths to which the Pascal compiler goes to convert apparently simple high-level statements into machine code. In many cases, Turbo Pascal generates very tight and fast-executing code. But, obviously, this is not one of those cases. With a little assembly language, we can do much better.

Figure 12.4 lists the disassembled assembly language that corresponds with the Pascal procedure `StrToASCIIz` (lines 35–44 in `STR.PAS`). The comments should help you to understand most of what's happening here. (Calls to undocumented Turbo Pascal runtime routines are marked "(internal sub)" and are not explained. When viewing this code in Turbo Debugger, some of the instructions will have slightly different formats.)

NOTE

Depending on your version of Turbo or Borland Pascal, the actual machine code produced may differ from that shown in Figure 12.4.

Lines 7–18 in Figure 12.4 point out one reason that even superb high-level language compilers like Turbo Pascal can sometimes generate slowly executing code. This procedure happens to have a string parameter `s` passed by value; therefore, the compiler correctly assumes that string `s` might be changed inside the procedure. As a result, and because strings and other arrays are *always* passed internally by address, the code at lines 7–18 blindly copies the entire string to a temporary work space on the stack—a process that repeats every time you call the procedure. However, as you can see in the Pascal code, the string is not changed, and all this code is unnecessary, a fact that the compiler just isn't smart enough to discern.

There are other places in this code (and in the other procedure, `ASCIIzToStr`) that could stand improvements, too. For example, line 28 apparently isn't needed as `ax` must already have the value stored at `[bp - 0102h]` due to the earlier instruction at line 24. These observations seem to suggest that pure assembly language routines will save space and run more quickly.

```

1: ; PROCEDURE StrTOASCIIZ( s : String; VAR a : ASCIIZString);
2:
3: PROC   StrTOASCIIZ   NEAR
4:
5:     push   bp           ; Save bp on stack
6:     mov    bp, sp       ; Address params with bp
7:     mov    ax, 0106h    ; Check if 106h stack bytes
8:     call   far ptr (internal sub) ; are available
9:     sub    sp, 0106h    ; Reserve stack space for s
10:    les    di, [dword ptr bp + 8] ; es:di = address of s
11:    push   es           ; Push source address (seg
12:    push   di           ; and offset)
13:    lea   di, [bp - 0100h] ; ss:di = address of s copy
14:    push   ss           ; Push destination address
15:    push   di           ; (seg and offset)
16:    mov    ax, 00ffh    ; Number of bytes to copy
17:    push   ax           ; Push count
18:    call   far ptr (internal sub) ; Copy string to temp variable
19:
20: ; Len := Length (s)
21:
22:     mov    al, [bp-0100h] ; Get length of s
23:     xor    ah, ah        ; Zero upper half of ax
24:     mov    [bp - 0102h], ax ; Initialize Len variable
25:
26: ; For I := 1 To Len Do
27:
28:     mov    ax, [bp - 0102h], ax ; Assign Len to ax
29:     mov    [bp - 0106h], ax ; Assign Len to stop value
30:     mov    ax, 0001h ; Assign start value to ax
31:     cmp    ax, [bp - 0106h] ; Is start > stop value?
32:     jg    @@09 ; If yes, skip For loop
33:     mov    [bp - 0104h], ax ; Else initialize I
34:     jmp    short @@08 ; Jump into Loop
35: @@07:
36:     inc    [word bp - 0104h] ; Increment control var (I)
37:
38: ; a[ I - 1 ] := s[I]
39:
40: @@08:
41:     mov    di, [word bp - 0104h] ; Assign I to di
42:     mov    dl, [byte bp+di-0100h] ; Get char at s[I]
43:     mov    ax, [word bp - 0104h] ; Set ax to I
44:     dec    ax ; Adjust ax to I - 1
45:     les    di, [dword bp + 04] ; es:di addresses a
46:     add    di, ax ; Advance di to a[I - 1]
47:     mov    [byte es:di], dl ; Store char from s[ I ]
48:     mov    ax, [word bp - 0104h] ; Set ax to control var ( I )
49:     cmp    ax, [word bp - 0106h] ; Compare with stop value
50:     jne    @@07 ; Jump if ax <> stop value
51:
52: ; a[ Len ] := Chr (0)
53:
54: @@09:
55:     mov    ax, [word bp - 0102h] ; Set ax to Len
56:     les    di, [word bp + 04] ; es:di addresses a
57:     add    di, ax ; es:di addresses a[ Len ]
58:     mov    [byte es:di], 0 ; Store 0 at a[ Len ]
59:
60: ; END; { StrToASCII }
61:
62:     mov    sp, bp ; Restore stack pointer
63:     pop    bp ; Restore saved bp register
64:     retn   8 ; Return saved bp register
65:
66: ENDP StrTo ASCIIZ

```

Figure 12.4.

Commented assembly language for the StrToASCIIZ procedure in STR.PAS (modified, nonoptimized version, renamed STRSLOW.PAS).

Optimizing STR.PAS

Listing 12.7, STR.ASM, replaces the `ASCIIZtoStr` and `StrToASCIIZ` procedures in STR.PAS with assembly language external routines. (If you've been following along, you copied STR.PAS to STRSLOW.PAS earlier. Be sure you have the original copy of STR.PAS on disk for the next steps.) Assemble, compile, and run the test with the commands:

```
tasm str
tpc str
str
```

Listing 12.7. STR.ASM.

```
1: %TITLE "ASCIIZ and Pascal Strings -- Copyright (c) 1989,1995 by Tom Swan"
2:
3:         IDEAL
4:
5:         MODEL    TPASCAL
6:
7:         CODESEG
8:
9:         PUBLIC  ASCIIZtoStr, StrToASCIIZ
10:
11: %NEWPAGE
12: ;-----
13: ; PROCEDURE ASCIIZtoStr( a : ASCIIZString; VAR s : String );
14: ;-----
15: PROC    ASCIIZtoStr    NEAR
16:     ARG a:dword, s:dword = ArgSize
17:     push    ds          ; Save Pascal's ds register
18:     les    di, [s]      ; Address s with es:di
19:     push    di          ; Save address for later
20:     inc    di           ; Address s[1] with es:di
21:     lds    si, [a]      ; Address a with ds:si
22:     cld                    ; Auto-increment si, di
23:     xor    cl, cl       ; Set Len (cl) to zero
24: @@10:
25:     cmp    cl, 255      ; Is Len = 255 yet?
26:     je     @@20         ; If yes, exit
27:     lodsb                    ; Get char (al <- a[I])
28:     or     al, al       ; Is al = 0 (ASCII null)?
29:     jz     @@20         ; If char = null, exit
30:     inc    cl           ; Len := Len + 1
31:     stosb                    ; s[ Len ] := a[ Len - 1 ]
32:     jmp    @@10        ; Loop until done
33: @@20:
34:     pop    di           ; es:di again addresses s[0]
35:     mov    [byte es:di], cl ; s[ 0 ] := Chr( Len )
36:     pop    ds          ; Restore Pascal's ds register
37:     ret                    ; Return to caller
38: ENDP    ASCIIZtoStr
39:
```

```

40: %NEWPAGE
41: ;-----
42: ; PROCEDURE StrToASCIIZ( s : String; VAR a : ASCIIZString );
43: ;-----
44: PROC     StrToASCIIZ     NEAR
45:     ARG s:dword, a:dword = ArgSize
46:     push  ds                ; Save Pascal's ds register
47:     les  di, [a]            ; Address a with es:di
48:     lds  si, [s]           ; Address s with ds:si
49:     cld                    ; Auto-increment si, di
50:     xor  ch, ch             ; Zero upper half of cx
51:     lodsb                   ; al := Length( s )
52:     mov  cl, al             ; cx = string length
53:     jcxz @@10               ; Exit if length = 0
54:     repnz movsb             ; Transfer s to a
55: @@10:
56:     mov  [byte es:di], cl    ; a[ Len ] := Chr( 0 )
57:     pop  ds                ; Restore Pascal's ds register
58:     ret                    ; Return to caller
59: ENDP     StrToASCIIZ
60:
61:     END                    ; End of module

```

How STR.ASM Works

You've seen all the instructions, commands, and other items in STR.ASM and, therefore, should have little trouble understanding how the code works. Notice how ARG is used to make addressing the parameters on the stack easy, without requiring confusing and error-prone specifications like [word bp + 4]. Also, the TPASCAL memory model lets Turbo Assembler initialize and restore bp automatically and add the proper immediate value to the ret instructions, removing parameters from the stack as necessary.

I used the memory model so that this example would work correctly with most versions of Turbo Assembler and Turbo Pascal. Remember: You don't need to use TPASCAL with Borland Pascal.

Pay special attention to lines 18, 21, and 47–48, which load es:di and ds:si with the addresses of the a and s parameters. Because this potentially changes ds—the variables may not be in the Pascal program's data segment—the procedures carefully preserve ds.

Another optimization technique demonstrated here takes advantage of the fact that, even though a is a value parameter to ASCIIZtoStr and that s is a value parameter to StrToASCIIZ, Turbo Pascal always passes strings and arrays by address. Therefore, because these variables aren't changed, the optimized external code skips the steps of copying the values as done in the code generated by the compiler.

NOTE

In this example, variables `a` and `s` are stored in the data segment and, if you run the test in Turbo Debugger, you may observe that `ds` doesn't actually change at lines 21 and 48. But another program could pass parameters to these procedures that are not stored in the data segment. In which case, `ds` probably would change. Such details are the source of many bugs, and the best prevention is a thorough knowledge of how Pascal works on the machine-code level. Don't assume that, just because you don't see a register value changing one time, that it won't change at another.

The speed gains in STR.ASM are mostly due to the use of fast 8086 string instructions at lines 27, 31, and 54. Contrast these instructions to the laborious methods employed in the pure Pascal output. (See Figure 12.4.) There's just no substitute for keeping values in fast general-purpose registers, using string indexes `si` and `di`, and taking advantage of powerful string instructions such as `lodsb` and `movsb`. As you can see, a little assembly language added to Pascal can go a long way toward improving program performance.

In Turbo Pascal's favor, I am forced to admit here that STR.PAS could be written to run quite a lot faster by using unique Turbo Pascal instructions such as `MOVE`. Even though I could be accused of "cooking the books" to create a good example of assembly language optimization, there are times when you may want to avoid Turbo's unique commands—even if this results in slower code. By restricting your programs to standard Pascal commands—as defined by Jensen and Wirth (see Bibliography)—your code will be easier to transfer to other systems. In fact, I sometimes write three versions of a program: one in standard Pascal, another optimized in Turbo Pascal, and a third optimized in assembly language, replacing procedures and functions from either of the first two versions. This takes extra work, of course, but also greatly improves the prospects that the code will run with minimum modifications on a variety of hardware.

Summary

Compilers are smarter today than ever before, but they're still no match for a clever assembly language programmer. Even programs compiled to super-fast code by Turbo Pascal can often be improved. But knowing how to add assembly language to Pascal is only half the story. Knowing when to do so is equally if not more important. Usually, it's best to convert only critical code, leaving noncritical sections in Pascal. To maintain a program's portability to other systems, it's also wise to write the Pascal statements first before converting critical sections to assembly language.

Finding the critical code is not always easy, but most experts agree that programs generally spend about 90% of their time executing about 10% of their instructions. Optimizing that critical 10% can greatly increase performance. Optimizing the other 90% may be a waste of time. A profiler can help identify critical sections by keeping statistical data about an executing program.

Turbo and Borland Pascal allow you to use `InLine` statements, `InLine` procedures and functions, and external procedures and functions to add assembly language to Pascal. The last of these is usually best because it improves the chances of porting the program to another system. External routines also can be assembled and debugged separately and might be usable with other languages, too.

Pascal's unusual memory model requires special handling, requiring you to declare data and code segments the hard way for the most flexible results. As an alternative, the `TPASCAL` memory model can be used with early versions of Turbo Pascal, although this has the disadvantage of adding startup instructions to every procedure, whether needed or not.

You can call external procedures and functions from Pascal, and you can call Pascal procedures and functions from assembly language. You must be careful to know which procedures are `NEAR` and which are `FAR`. You can also import data from Pascal into external modules, but because Pascal lacks an `EXTERNAL` directive for variables, you can't export data from assembly language to Pascal. (You can pass the addresses of external data to Pascal and, with this method, gain access to external variables.)

Writing Pascal functions requires extra care to be sure that proper values are passed back to callers in the correct registers. Parameters further complicate the job of writing external code, requiring assembly language modules to address variables on the stack. Using the `ARG` directive can help (especially when used with the `TPASCAL` memory model) by letting external code address parameters by name instead of error-prone expressions such as `[bp + 8]`. `TPASCAL` is not required with Borland Pascal.

Of course, the ultimate goal of adding assembly language to Pascal is to add speed to programs. As an example in this chapter demonstrates, the results of optimizing can save memory, reduce code-file size, and greatly enhance performance.

Exercises

- 12.1. What is "critical code"?
- 12.2. What does a profiler do?
- 12.3. The `c1c` instruction's machine code is `0F8h`. The `stc` instruction's machine code is `0F9h`. Write `InLine` statements and procedures using these instructions to set and clear the carry flag.

- 12.4. What is the correct way to code the following Pascal procedure declaration in an external assembly language module?

```
{SF+}
PROCEDURE PlayBall;
```

- 12.5. Suppose you have an external assembly language module named NEWSTUFF.ASM, assembled to NEWSTUFF.OBJ. In it are one procedure OldStuff and an integer function OlderStuff. What Pascal statements are required to incorporate the Pascal and assembly language files?

- 12.6. Why is the TPASCAL memory model potentially disadvantageous? What are the advantages and alternatives?

- 12.7. Given the following Pascal declarations, write the directive or directives required to import the values into an assembly language module. Which (if any) of these declarations can't be imported into the external module?

```
TYPE    Months = (Jan, Feb, Mar, Apr, May,
                 Jun, Jul, Aug, Sep, Oct, Nov, Dec);
```

```
CONST   MaxLevel = 17;
        AreaCode : Integer = 555;
        Esc = #27;
```

```
VAR     YourName : String;
        Score : Integer;
        SalesPerMonth : Array[ Months ] OF Integer;
```

- 12.8. Given the following Pascal procedure, write the necessary instructions to call the routine from inside an assembly language module named ASCII.OBJ:

```
PROCEDURE WriteASCII( ch : Char );
BEGIN
    WriteLn( 'ASCII value = ', Ord(ch) )
END;
```

- 12.9. Suppose you have a global variable declared with `dd` named LongValue. What assembly language instructions do you need to use to pass this value back to Pascal as a function result type?
- 12.10. [Advanced.] Using an `ARG` directive and, for Turbo Pascal, assuming the TPASCAL memory model is being used, write the assembly language code required to replace the Pascal LotsOfParams procedure shown here with an external module that loads parameter `a` into `cx` and `b` into `dx`, adds 5 to `number`, and loads `al` with `ch`. Write a Pascal program to test your code. (Hint: Write a Pascal version first, examine the code in Turbo Debugger, and *then* write the assembly language module.)

```
PROCEDURE LotsOfParams( a, b : Integer;
                       VAR number : Integer; VAR ch : char );
```

Projects

- 12.1. Convert the STRINGS module from Chapter 5 to external procedures that can be linked to Pascal programs, adding ASCIIZ string abilities to Turbo Pascal.
- 12.2. Write a terminal emulator in Pascal, using external procedures from Chapter 10's ASYNCH module to initialize and drive the serial I/O port.
- 12.3. Identify the critical code as best you can in a sizable Pascal program, preferably one of about 1,000 lines. (Most public domain libraries have suitable candidates.) Optimize key procedures and functions in the program and document the improvements.
- 12.4. Pascal's `write` and `writeln` have to handle multiple parameters, integers, real numbers, and strings. They're handy, but they can also produce needlessly lengthy machine-code instruction sequences. Write simplified string I/O procedures for writing Pascal string variables to the standard output.
- 12.5. Develop a fast direct-video package in assembly language for displaying strings at high speed on PCs.
- 12.6. Use Turbo Debugger to examine the machine code for Turbo Pascal's standard CRT unit, supplied with most versions of Turbo and Borland Pascal. Identify and comment as many of the instructions as you can. (Doing this is a good way to learn how Pascal compiles programs, but don't worry if you can't figure out every instruction.)

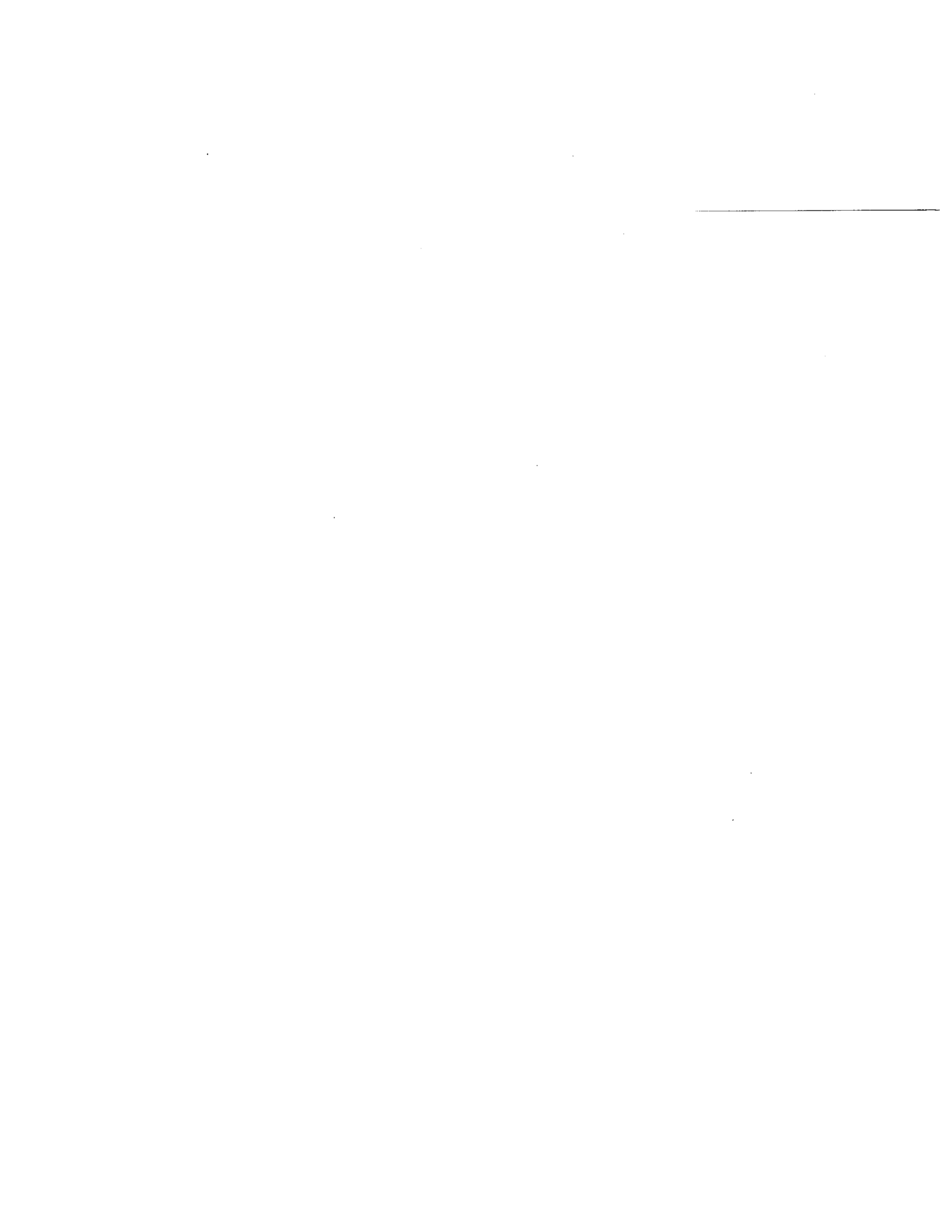

13

CHAPTER

Mixing Assembly Language with C and C++

- Mixing C and C++ with Assembly Language, 532
- Identifying Critical Code, 532
- Using Registers, 533
- Inline Assemblies, 533
- Sharing Data, 538
- External Assemblies, 544
- Calling Assembly Language Functions from C, 550
- Assembling and Linking External Modules, 551
- Debugging Multilanguage Programs, 554
- Calling C Functions from Assembly Language, 555
- Function Results, 557
- LOCAL Variables, 558
- Calling C++ Functions from Assembly Language, 560
- Passing Function Arguments, 565
- Mixing C++ Classes with Assembly Language, 570
- Summary, 579
- Exercises, 580
- Projects, 581

Mixing C and C++ with Assembly Language

The reasons for adding assembly language to Turbo C and Borland C++ programs are the same as the reasons discussed in Chapter 12 for optimizing Turbo Pascal—speed and access to the lowest reaches of the hardware. But the pitfalls are identical, too—reduced program portability and an increased likelihood of bugs. For most programs, Borland C and C++ compilers generate tight fast code that’s hard to beat. Still, no compiler is as clever as a crack assembly language expert, and, many times, the only way to add real zip to a program is to drop a little machine code into your deep and true blue “C” using one of two methods:

- Inline statements
- External functions

Inline statements inject assembly language directly into C and C++ source code. This technique is quick and easy but does have a few drawbacks, as I’ll explain later. *External functions*, while more difficult to manage than inline statements, have the advantage of giving you full access to all of Turbo Assembler’s features. This chapter examines both methods, listing many examples that you can use as templates for your own projects.

NOTE

This chapter assumes that you have some familiarity with C and C++ and that you know how to install and run your compiler. You may use the sample programs in this chapter with most versions of Turbo Assembler, Turbo C, Turbo C++, and Borland C++, although some examples near the end of the chapter require Borland C++ and Turbo Assembler Versions 4.0 or greater. Also, while reading this chapter, if you experience a little *déjà vu*, don’t be alarmed. A few paragraphs from Chapter 12 are intentionally duplicated here.

Identifying Critical Code

As explained in Chapter 12, a program’s critical code usually amounts to about 10% of the instructions, which often can share as much as 90% of the processing burden. Rewriting this critical 10% in fast assembly language should produce remarkable speed improvements, while optimizing the other 90% may be a waste of time. For this reason, the primary mixed-language rule to remember is: Don’t rewrite statements that already run as fast as necessary.

Locating a program’s critical code is not always easy. Sometimes, your familiarity with the program will tell you which sections could stand a little extra juice. At other times, you’ll need the help of a commercial profiler, such as Borland’s Turbo Profiler, to monitor a program and create a statistical report, listing heavily traveled routines.

A good battle plan is to write your program entirely in C and C++ and then, after debugging your code, convert selected areas to assembly language. Keep track of the results as you go along and try to keep the amount of assembly language to a minimum. That may seem to be strange advice to find in an assembly language book, but one of the main reasons for writing a program in a high-level language is to improve the chances for transferring the code to another computer. To keep these chances alive, it's probably best to use as little assembly language as possible. (Besides, a little machine code goes a long way.)

Using Registers

You can use all processor registers in your assembly language routines. To prevent mishaps in C and C++ functions, you must restore `bp`, `cs`, `ds`, `sp`, and `ss` to the values they had at the start of your routine. You can safely assume that calls to other functions will not change these registers.

Registers `ax`, `bx`, `cx`, `dx`, `di`, `si`, and `es` are free for the taking, and you do not have to preserve the values of these registers before your routine ends. This freedom applies to other functions, too, so be aware that these same registers can change if you call C and C++ functions from your assembly language routines.

Because the compiler uses `di` and `si` for register variables, if you use either of these two registers in inline assembly language statements, the compiler turns off register variable optimizations, avoiding a possible conflict with your code. Unfortunately, this can also slow down the very code you're trying to revise for extra speed. For this reason, it's usually best to avoid using `di` and `si` unless absolutely necessary. When linking external assembly language modules, it's up to you to preserve `si` and `di` for other functions that use register variables.

Inline Assemblies

An inline assembly language statement begins with the word `asm` and is followed by an assembly language mnemonic plus any operands required by the instruction. For example, to synchronize a program with an external interrupt signal, you can write:

```
/* wait for an interrupt */
asm sti
asm hlt
printf("Interrupt received\n");
```

When early versions of Turbo C compile a program with embedded `asm` commands, the compiler first creates an assembly language text file for the *entire* program, inserting your assembly language instructions along with the compiled code for other C statements into the text. The compiler then calls Turbo Assembler and Linker to assemble and link the program into the final code file. More recent versions of Turbo and Borland C++ can compile `asm` statements without calling TASM. The complete syntax for `asm` is:

```
asm [label] mnemonic/directive operands[;][/* C comment*/]
```

The optional *label* is allowed only for data directives. You can't label instruction mnemonics. For example, to create a word variable named `ForWord`, you can write:

```
asm ForWord dw ?
```

To label an instruction in a function, you must use a *C label*—an identifier followed by a colon:

```
ThisLocation:
asm inc ax

...
asm or ax, ax
asm jz ThisLocation
```

The *mnemonic/directive* may be any legal assembly language instruction or Turbo Assembler directive. The *operands* to the mnemonic or directive are the same as those used in “pure” assembly code. For example, you can increment an integer variable named `Level` with the command:

```
int Level;
asm inc [word Level];
```

Notice that the word qualifier is necessary to tell the assembler the size of the `Level`. You have to add `word`, `byte`, `tbyte`, and other qualifiers only if the size of a variable is ambiguous. In unambiguous cases, you can leave the qualifier out:

```
int Bevel;
asm mov ax, [Bevel];
```

This moves the value of `Bevel` into `ax`. Because `ax` is a word register, Turbo Assembler assumes that `Bevel` is the same size. Also, as demonstrated here, you don't have to be concerned with *where* variables are located—the same assembly language constructions work for variables on the stack or variables in the data segment—just use the variable names as in these samples.

The semicolon at the end of an `asm` statement is optional. Don't confuse the semicolon with an assembly language comment character—the compiler removes the semicolon before assembly. For this reason, to comment an assembly language statement, you must use C-style comments as in:

```
int Swivel;
int Drivel;
asm mov cx, [Swivel]; /* Load cx with value of Swivel */
asm shl ax, cl /* Shift ax left by value in cl */
asm mov [Drivel], ax; /* Save shifted ax in Drivel */
```

The semicolons at the ends of the `asm` lines and the C comments between `/*` and `*/` are stripped from the text before assembly. (I prefer to leave out the semicolons as in the middle `asm` statement in the example.)

Compiling and Assembling Inline Code

There are several ways to compile C programs with embedded `asm` instructions. To demonstrate the differences between these methods, refer to Listing 13.1, `TALLY.C`. The notes after the listing explain how to compile the program.

Listing 13.1. `TALLY.C`.

```
1: /* TALLY.C ---- A Short Inline Assembly Language Example */
2:
3: #include <stdio.h>
4:
5: int main(void)
6: {
7:     int votes;
8:     int tally;
9:
10:    votes = 100;
11:    tally = 500;
12:    printf("Tally : %d\n", tally);
13:    asm mov ax, [votes];
14:    asm add [tally], ax;
15:    printf("Tally : %d\n", tally);
16:    return 0;
17: }
```

How To Compile `TALLY.C`

`TALLY.C` uses two embedded `asm` statements to add the value of an integer variable `votes` to another variable `tally`, having the same effect as the C statement:

```
tally = tally + votes;
```

With early versions of Turbo C, to compile, assemble, and link the program, use the command:

```
tcc tally
```

You must use the DOS command-line compiler `TCC.EXE` for this. You can't use the integrated editor and compiler program `TC.EXE` to compile programs containing inline `asm` statements. During compilation, when Turbo C reaches the first `asm` statement, it displays "Warning 13" and restarts compiling the program from the beginning. Normally, Turbo C compiles directly to `.OBJ` code files and then calls Turbo Linker to join the program's object and library modules to create the final `.EXE` code file. Because of the embedded `asm` statements, Turbo C instead compilers to an `.ASM` text file, in this case creating the file `TALLY.ASM`. This file contains the entire C program in assembly language form along with the `asm` statements. Next, Turbo C calls Turbo Assembler to assemble `TALLY.ASM` to `TALLY.OBJ`. Then, after removing `TALLY.ASM` from disk, the compiler calls Turbo Linker to link `TALLY.OBJ` with an appropriate Turbo C library and other files, creating the finished `TALLY.EXE` code file—lots of action for such a short command.

The problem with this method is the time wasted by compiling the program up the first `asm` statement, when Turbo C finally realizes it has to generate an assembly language text file instead. You can avoid this by specifying the `-B` option on the command line. (The `B` must be in uppercase.) For example:

```
tcc -B tally
```

compiles `TALLY.C` to `TALLY.ASM`, assembles `TALLY.ASM` to `TALLY.OBJ`, and links `TALLY.OBJ` with a library file to create `TALLY.EXE`. `TALLY.ASM` is erased from disk. To save the assembly language text file, use the `-S` option (which also must be in uppercase):

```
tcc -S tally
```

This compiles `TALLY.C` to `TALLY.ASM` but does not assemble to link the result. Use this command when you want to examine the assembly language generated by Turbo C, giving you a close look at the instructions used to implement commands such as for loops and function calls. After examining the assembly language text, repeat the compilation with a `-B` command to create the finished program. (You can also assemble `TALLY.ASM` separately, but then you'll have to run Turbo Linker to join `TALLY.OBJ` with an appropriate Turbo C run-time library as explained in the Turbo C User's Guide and later in this chapter.)

More recent versions of Turbo C++ and Borland C++ can compile `asm` statements directly without creating an intermediate `.ASM` text file. Because the C++ compilers normally expect filenames to end with the extension `.CPP`, you must specify `.C` for C programs. For example, to compile `TALLY.C` with Borland C++ 4 or 4.5, type this instruction at a DOS prompt (change `bcc` to `tcc` if you are using Turbo C++):

```
bcc tally.c
```

You can still create the intermediate assembly language text, and have the compiler call Turbo Assembler to assemble the program, by specifying the `-B` option:

```
bcc -B tally.c
```

Or, use `-S` to save the assembly language file (`TALLY.ASM`) for inspection with a text editor:

```
bcc -S tally.c
```

Pragmatic Assemblies

Another method to compile programs such as `TALLY.C` with embedded `asm` commands is to insert the line:

```
#pragma inline
```

at the beginning of the module. To try this, add `#pragma inline` to `TALLY.C` between lines 1 and 2 (or as the first line) and compile with the command:

```
tcc tally
```

As you can see, the `#pragma` directive—an ANSI C standard method for activating a compiler's custom features—does the same job as the `-B` command-line option, avoiding the time that's otherwise wasted restarting the compiler after reaching the first `asm` statement.

You may use this same method with more recent versions of Turbo C++ and Borland C++. However, because these compilers can compile `asm` statements directly, there's usually little reason to use the `#pragma inline` directive. Doing so causes the compilers to generate intermediate `.ASM` files and to call Turbo Assembler. Unless you have a good reason for compiling your programs this way, the end result is simply a waste of time.

Locations for Data and Code Statements

Every line of C and C++ code is either inside or outside a function, and you can insert `asm` statements in both places. The exact location of an `asm` statement affects where the code or directive is assembled. When an `asm` statement appears outside a function, it's assembled into the program's data segment. When an `asm` statement appears inside a function, it's assembled into the program's code segment. Usually, to create variables, you'll insert `asm` statements outside functions; to create code, you'll insert them inside functions. Here's a sample of both uses:

```
asm count db ?
int main()
{
    asm shl [count], 1    /* multiply count by 4 */
    asm shl [count], 1
    return 0;
}
```

The variable `count` is declared in the program's data segment (relative to `ds`). The statements inside function `main` multiply `count` by 4, using fast shift instructions instead of `mul`. If you declare variables inside a function, the data is assembled into the code segment, requiring special handling:

```
int main()
{
    asm jmp OverThere
    asm count db ?
OverThere:
    asm shl [count], 1    /* multiply count by 4 */
    asm shl [count], 1
    return 0;
}
```

Because the variable `count` is now in the code segment, a `jmp` instruction is required to avoid accidentally executing the value of `count` as machine code. Notice that the `shl` references to `count` are unchanged—the compiler automatically inserts segment overrides (in this case, `cs`) as needed to refer to variables in their proper segments.

The problem with this method is the time wasted by compiling the program up the first `asm` statement, when Turbo C finally realizes it has to generate an assembly language text file instead. You can avoid this by specifying the `-B` option on the command line. (The `B` must be in uppercase.) For example:

```
tcc -B tally
```

compiles `TALLY.C` to `TALLY.ASM`, assembles `TALLY.ASM` to `TALLY.OBJ`, and links `TALLY.OBJ` with a library file to create `TALLY.EXE`. `TALLY.ASM` is erased from disk. To save the assembly language text file, use the `-S` option (which also must be in uppercase):

```
tcc -S tally
```

This compiles `TALLY.C` to `TALLY.ASM` but does not assemble to link the result. Use this command when you want to examine the assembly language generated by Turbo C, giving you a close look at the instructions used to implement commands such as `for` loops and function calls. After examining the assembly language text, repeat the compilation with a `-B` command to create the finished program. (You can also assemble `TALLY.ASM` separately, but then you'll have to run Turbo Linker to join `TALLY.OBJ` with an appropriate Turbo C run-time library as explained in the Turbo C User's Guide and later in this chapter.)

More recent versions of Turbo C++ and Borland C++ can compile `asm` statements directly without creating an intermediate `.ASM` text file. Because the C++ compilers normally expect filenames to end with the extension `.CPP`, you must specify `.C` for C programs. For example, to compile `TALLY.C` with Borland C++ 4 or 4.5, type this instruction at a DOS prompt (change `bcc` to `tcc` if you are using Turbo C++):

```
bcc tally.c
```

You can still create the intermediate assembly language text, and have the compiler call Turbo Assembler to assemble the program, by specifying the `-B` option:

```
bcc -B tally.c
```

Or, use `-S` to save the assembly language file (`TALLY.ASM`) for inspection with a text editor:

```
bcc -S tally.c
```

Pragmatic Assemblies

Another method to compile programs such as `TALLY.C` with embedded `asm` commands is to insert the line:

```
#pragma inline
```

at the beginning of the module. To try this, add `#pragma inline` to `TALLY.C` between lines 1 and 2 (or as the first line) and compile with the command:

```
tcc tally
```

As you can see, the `#pragma` directive—an ANSI C standard method for activating a compiler's custom features—does the same job as the `-B` command-line option, avoiding the time that's otherwise wasted restarting the compiler after reaching the first `asm` statement.

You may use this same method with more recent versions of Turbo C++ and Borland C++. However, because these compilers can compile `asm` statements directly, there's usually little reason to use the `#pragma inline` directive. Doing so causes the compilers to generate intermediate `.ASM` files and to call Turbo Assembler. Unless you have a good reason for compiling your programs this way, the end result is simply a waste of time.

Locations for Data and Code Statements

Every line of C and C++ code is either inside or outside a function, and you can insert `asm` statements in both places. The exact location of an `asm` statement affects where the code or directive is assembled. When an `asm` statement appears outside a function, it's assembled into the program's data segment. When an `asm` statement appears inside a function, it's assembled into the program's code segment. Usually, to create variables, you'll insert `asm` statements outside functions; to create code, you'll insert them inside functions. Here's a sample of both uses:

```
asm count db ?
int main()
{
    asm shl [count], 1    /* multiply count by 4 */
    asm shl [count], 1
    return 0;
}
```

The variable `count` is declared in the program's data segment (relative to `ds`). The statements inside function `main` multiply `count` by 4, using fast shift instructions instead of `mul`. If you declare variables inside a function, the data is assembled into the code segment, requiring special handling:

```
int main()
{
    asm jmp OverThere
    asm count db ?
OverThere:
    asm shl [count], 1    /* multiply count by 4 */
    asm shl [count], 1
    return 0;
}
```

Because the variable `count` is now in the code segment, a `jmp` instruction is required to avoid accidentally executing the value of `count` as machine code. Notice that the `shl` references to `count` are unchanged—the compiler automatically inserts segment overrides (in this case, `cs:`) as needed to refer to variables in their proper segments.

Enabling 80286/386 Instructions

You can enable 80286 and 80386 instructions by inserting appropriate Turbo Assembler directives into the code. For example, to switch on non-protected 80286 instructions, use the command:

```
asm .286C
```

Remember to use the MASM format instead of the Ideal-mode equivalent P286N, unless you also switch to Ideal mode. If you do this, remember to switch back to MASM mode, which is used for the compiler's own assembly language output:

```
asm Ideal      /* switch on Ideal mode */
asm P286N     /* enable 80286 non-protected instructions */
asm MASM      /* switch back to MASM mode */
```

Sharing Data

Inline `asm` statements have ready access to C and C++ variables and structures—one of the most attractive advantages of the inline method over the traditional external module approach (described later in this chapter). Table 13.1 lists C and C++ data types, showing the assembly language qualifiers to use in ambiguous references, the number of bytes occupied by variables of each type, and the equivalent Turbo Assembler directive to create variables of the same size. Note that `dq` can be used to create initialized `double` floating point variables in assembly language but that there is no Turbo Assembler directive to create `float` variables directly.

In `asm` statements, you can refer to named C variables of the types in Table 13.1 with code such as:

```
unsigned char initial;

initial = 'T';
asm mov dl, [initial] /* Load character into dl */
asm mov ah, 2         /* Send character to DOS */
asm int 21h          /* standard output function */
```

Table 13.1. C and C++ Data Types.

<i>Data Type</i>	<i>Qualifier</i>	<i>Bytes</i>	<i>Directive</i>
unsigned char	Byte ptr	1	db
char	Byte ptr	1	db
enum	Word ptr	2	dw
unsigned short	Word ptr	2	dw
short	Word ptr	2	dw
unsigned int	Word ptr	2	dw

Data Type	Qualifier	Bytes	Directive
int	Word ptr	2	dw
unsigned long	Dword ptr	4	dd
long	Dword ptr	4	dd
float	Dword ptr	4	-
double	Qword ptr	8	dq
long double	Tbyte ptr	10	dt
near *	Word ptr	2	dw
far *	Dword ptr	4	dd

The unsigned character variable `initial` is loaded into `d1` by an `asm` statement. From Table 13.1, because `d1` and the `unsigned char` data type are both bytes, there's no need to use a `Byte` qualifier in the reference, although doing so is harmless:

```
asm mov d1, [Byte ptr initial]
```

The brackets, which are normally used to indicate a reference to memory rather than the value (that is, the address) of a label, result in the assembly language statement:

```
mov d1, [[Byte ptr initial]]
```

The double brackets cause no trouble, so don't worry about them. (Unless you're compiling with the `-s` option, you won't see these brackets anyway.) You can avoid this odd double-bracket behavior by not using brackets in the `asm` statement:

```
asm mov d1, initial
```

although now, the program is less clear. (Does `initial` refer to the address or the value of this variable?)

Declaring Assembly Language Data

You can also declare variables for use only by your assembly language statements. For example, to create a 16-bit word named `TwoBytes` and load the variable's value into `cx`, you can write:

```
asm TwoBytes db 1, 2
int main()
{
    asm mov cx, [Word ptr TwoBytes]
    return 0
}
```

The `TwoBytes` variable is declared in the program's data segment (outside a function), using the `db` directive to store 2 bytes (1 and 2) in memory. An assembly language statement then loads the value of `TwoBytes` into `cx`, setting `cl` to 1 and `ch` to 2. The `Word ptr` qualifier is necessary to refer to `TwoBytes` as a 16-bit word.

Because `TwoBytes` is declared in an `asm` statement, you can't refer to the variable with C or C++ code. For this reason, unless you need private variables for your assembly language instructions, you'll usually declare variables and refer to them from assembly language.

C Structures

Member (field) names in structures are internally stored as offset values from the beginning of the structure. For example, the structure:

```
struct PersonRec {
    char Name[50];
    char Address[60];
    char CityStZip[60];
    char AgeInYears;
} Person;
```

assigns offset values to `Name`, `Address`, and `CityStZip` representing the positions of these fields in the `PersonRec` structure. Keeping this fact in mind, you have to use both the variable and member identifiers separated by a period to refer to structure fields in an assembly language statement:

```
asm mov si, offset Person.Address
```

which assembles to:

```
mov si, 0038h
```

The `0038h` (which might be a different value on your system if you view this in Turbo Debugger) represents the offset from the beginning of the data segment to the `Address` field—that is, `Person + Address`. Contrast this with the instruction:

```
asm mov al, Byte ptr Person.AgeInYears
```

which assembles to:

```
mov al, Byte ptr DGROUP:_Person + 170
```

In this case, the *value* of the `AgeInYears` field is loaded into `al`. The `170` represents the offset value of this field from the start of the `Person` record. (the compiler adds underscores to variable names—but more about that later.)

Many times, you'll want to refer to structures with pointers, usually loaded into `bx`. For example, to initialize `bx` to the address of the `Person` record, use the statement:

```
asm mov bx, offset Person
```

With `ds:bx` addressing `Person`, you can now load the values or addresses of other fields relative to the pointer:

```
asm mov dl, [bx.AgeInYears]
```

No size qualifier such as `Byte ptr` is needed because both the field and register are the same size.

When two or more structures have identical field names, you must resolve ambiguous pointer references by adding the structure name in parentheses before field names. For example, suppose there is another record type named `Customers` with a field `CityStZip`—the same field name as in the `PersonRec` structure. To load `si` with the offset address of the `CityStZip` field from a variable `TheBaker` of type `Customers` addressed by `bx`, you can write:

```
asm mov bx, offset TheBakery
asm lea si, [bx.(struct Customers) CityStZip]
```

The first `asm` command loads `bx` with the offset address of `TheBakery`. The second command loads `si` with the effective address of the `CityStZip` field relative to `bx`. The structure name in parentheses lets the compiler resolve the ambiguous field name reference to `CityStZip`.

Sharing Code

Inline assembly language statements can call C and C++ functions, and C and C++ statements can call functions written entirely in assembly language. Let's start with the easier of these two techniques, showing how to write a complete function in assembly language and call that function with C statements. Compile, assemble, and link Listing 13.2, `UPDOWN.C`, and with the command:

```
tcc -v updown.c
```

If you are using Borland C++, replace `tcc` with `bcc`.

You need to use the `-v` option only if you want to examine the source code while running the program in Turbo Debugger. If you want to examine the assembly language output, enter the following command and use your test editor to view the `UPDOWN.ASM` file:

```
tcc -S updown.c
```

Listing 13.2. UPDOWN.C

```
1: /* Inline Assembly Language Function Demonstration */
2:
3: #pragma inline
4:
5: #include <stdio.h>
6: #include <string.h>
7:
8: extern void BumpStrUp(unsigned char far * TheString,
9:   int StringLength);
10:
11: extern void BumpStrDown(unsigned char far * TheString,
12:   int StringLength);
```

continues

Listing 13.2. continued

```

13:
14: char *MixedUp = "UpPER aNd LOWEr CaSE";
15:
16: int main()
17: {
18:     printf("Before BumpStrUp: %s\n", MixedUp);
19:     BumpStrUp( MixedUp, strlen(MixedUp) );
20:     printf("After BumpStrUp: %s\n", MixedUp);
21:     BumpStrDown( MixedUp, strlen(MixedUp) );
22:     printf("After BumpStrDown: %s\n", MixedUp);
23:     return 0;
24: }
25:
26: void BumpStrUp(unsigned char far * TheString,
27:     int StringLength)
28: {
29:     asm les di, TheString           /* Address string with es:di */
30:     asm mov cx, StringLength       /* Load string length into cx */
31:     asm jcxz Exit                 /* Exit if length = 0 */
32:     asm cld                       /* Auto-increment di */
33: NextChar:
34:     asm mov al, es:[Byte ptr di]  /* Load next character */
35:     asm cmp al, 'a'               /* Skip conversion if */
36:     asm jb NotLower              /* character is not */
37:     asm cmp al, 'z'               /* lowercase */
38:     asm ja NotLower
39:     asm sub al, 32                 /* Convert to uppercase */
40: NotLower:
41:     asm stosb                     /* Store character in string */
42:     asm loop NextChar             /* Loop until done */
43: Exit:;
44: }
45:
46: void BumpStrDown( unsigned char far * TheString,
47:     int StringLength )
48: {
49:     asm les di, TheString         /* Address string with es:di */
50:     asm mov cx, StringLength     /* Load string length into cx */
51:     asm jcxz Exit                 /* Exit if length = 0 */
52:     asm cld                       /* Auto-increment di */
53: NextChar:
54:     asm mov al, es:[Byte ptr di]  /* Load next character */
55:     asm cmp al, 'A'               /* Skip conversion if */
56:     asm jb NotUpper              /* character is not */
57:     asm cmp al, 'Z'               /* uppercase */
58:     asm ja NotUpper
59:     asm add al, 32                 /* Convert to lowercase */
60: NotUpper:
61:     asm stosb                     /* Store character in string */
62:     asm loop NextChar             /* Loop until done */
63: Exit:;
64: }

```

How UPDOWN.C Works

Lines 8-12 declare two external functions `BumpStrUp` and `BumpStrDown`, which convert strings to all uppercase or to all lowercase. For convenience, the functions are listed together with the main program, but they could be in separate modules if you're prepared to handle all the details of linking the modules to create a finished executable code file.

The main function (lines 16-24) calls the external functions, displaying the effect on a string variable (line 14) addressed by a far pointer. Function `BumpStrUp` (26-44) lists two parameters, a far `char` pointer and an integer representing the string length. The first assembly language instruction (line 29) uses `les` to load the `es:di` registers with the full 32-bit address of the string. You should be able to understand the purpose of the other instructions from the comments to the right of most lines.

Line 43 illustrates an idiosyncrasy of labels in ANSI C, which specifies that a label must be followed by a statement. Because you assembly language code needs a method to jump to the end of the function, this poses a problem—solved here by an extra semicolon after the `Exit:` label.

The `BumpStrDown` function (lines 46-64) is nearly the same as `BumpStrUp` except for lines 55-59, which convert uppercase letters to lowercase.

Behind the Scenes

`UPDOWN.C` has a few backstage surprises that are not evident from the program listing. As you'll discover if you examine the assembly language output, both `BumpStrUp` and `BumpStrDown` begin with the instructions:

```
push  bp           ; Save bp on stack
mov   bp, sp      ; Address stack with bp
push  si          ; Save si
push  di          ; Save di
```

The first and second instructions save `bp` before equating this same register with `sp`, preparing to address parameters on the stack. The second and third instructions save the values of `si` and `di`. This is done because the functions use `di`; therefore, the compiler takes the safe route and saves both `si` and `di` to avoid all possibility of a conflict with any register variables used by other routines that may call this one. Later on, both functions end with:

```
pop   di          ; Restore saved di
pop   si          ; Restore saved si
pop   bp          ; Restore saved bp
ret                               ; Return to caller
```

This restores `di`, `si`, and `bp` to their original values before returning to the instruction following the `call` that activated the function.

As you can see from this, when using embedded `asm` statements, the compiler takes care of the details associated with addressing parameters, saving and restoring register variables, keeping the stack “right,” and manipulating `bp`. While this is certainly helpful, there are disadvantages to having so much help. For one thing, neither custom function uses `si`; therefore, saving and restoring this register is a waste of time. Also, in this case, there isn’t any need to save and restore `di` either because the main program, which calls the custom functions, has no register variables, and no conflict is possible by changing `di`.

For better control over such details—and to avoid having to preface each assembly language statement with `asm`—you can write external assembly language modules to link to Turbo C programs. This takes more work, but the results are often worth the trouble, as the next section explains.

External Assemblies

Because Turbo Assembler and Borland C and C++ compilers can create the same `.OBJ` code-file format, you can write portions of a program in C or C++ and other parts in assembly language, and then use Turbo Linker to join the object-code files into the finished `.EXE` program. The compilers are also able to run the assembler and linker directly, simplifying compilation, at least for relatively small programs. Despite adding complexity to a programming project, external assembly language methods offer several advantages over inline `asm` statements:

- Reduced compilation time
- Assembly language modules can use Ideal mode
- No “hidden” instructions are added
- The C or C++ program retains a higher degree of portability
- External routines can be debugged separately
- External routines can be used with other languages

Compilation times are reduced because the compiler no longer has to generate an assembly language text file, required for assembling embedded inline `asm` statements. You can use the preferred Ideal mode in your assembly language modules, which also helps Turbo Assembler to run fast. No extra instructions, stack manipulations, or push and pop instructions are added—items that the compiler inserts into inline `asm` functions whether needed or not.

If you write your programs purely in C or C++ and then selectively convert individual functions to assembly language, you will improve your program’s portability. After optimizing, if you need to transfer a program to another computer—for example, a Macintosh with a 68000 processor—it’s relatively simple to replace the optimized assembly language modules

with the original C code that you wisely saved on disk. Then, after the program is working correctly on the new computer, you would start optimizing sections of the code in that computer's native tongue.

External assembly language routines can also simplify debugging. You can assemble and debug external routines apart from the main program—a far easier task than hunting for small monsters in the jungle of an 80K code file. You might also be able to use your external routines with other languages. Despite these many advantages, there are a few drawbacks to be aware of when using external routines:

- You can no longer mix C and C++ and assembly language statements as you can with `asm` statements. You must code entire functions in assembly language.
- You must have a good understanding of segments and segment registers, addressing modes, simplified memory models, and related directives. (Of course, you've carefully read every word in this book, so these details won't give you any problems.)
- The steps to compile and link a program may be more complex, although the compiler can help by running the assembler and linker directly.

Simplified Memory Models

The good news about external routines is that “hard-way” `SEGMENT` directives are completely unnecessary. Segment names, classes, and other segment options are identical for C and C++ and Turbo Assembler memory models. This means you can use simplified memory-model directives such as `DATASEG`, `CODESEG`, `FARDATA`, and `CONST` to organize your assembly language module's data and code segments. If you really must declare segments manually, you can certainly do so—as long as you're careful to follow the various conventions expected by the compiler and linker. I can hardly imagine a situation where this is necessary, however, so I won't waste space discussing the details here. Consult your C and C++ user's and reference guides for more information.

Listing 13.3, `CSHELL.ASM`, shows one of the many possible ways to organize an external assembly language module. You can use `CSHELL` as a template for your own designs, inserting various items where shown by comments in the listing. There's no reason to assemble this program—it doesn't do anything useful, but you can assemble it with:

```
tasm /ml cshell
```

The `/ml` option tells Turbo Assembler to switch on case sensitivity. This matches the way C and C++ compilers work, considering names such as `MyFunction` and `myfunction` to be *different* identifiers.

Listing 13.3. CSHELL.ASM.

```

1: %TITLE "Shell for C .OBJ modules -- by Tom Swan"
2:
3:         IDEAL
4:
5:         MODEL    small
6:
7: DATASEG
8:
9: ;----- Insert PUBLIC data declarations here
10:
11: ;----- Insert EXTRN data declarations here
12:
13: ;----- Insert initialized variables here
14:
15:
16: FARDATA
17:
18: ;----- Insert far data segment variables here
19:
20:
21: CODESEG
22:
23: ;----- Insert PUBLIC code declarations here
24:
25: ;----- Insert EXTRN code declarations here
26:
27:
28: %NEWPAGE
29: ;-----
30: ; <type> funcname( <parameters> )
31: ;-----
32: PROC    funcname        NEAR
33:         push    bp
34:         mov     bp, sp
35:
36: ;         sub     sp, n           ; Optional: reserve space for locals
37: ;         push   di           ; Optional: save register var di
38: ;         push   si           ; Optional: restore register var si
39:
40: ;----- Insert instructions here
41:
42: ;         pop    si           ; Optional: restore si
43: ;         pop    di           ; Optional: restore di
44: ;         mov     sp, bp       ; Optional: restore sp
45:
46:         pop     bp           ; Restore old bp pointer
47:         ret                    ; Return to caller
48: ENDP    funcname
49:
50:         END                    ; End of module

```

NOTE

If your assembly language module declares no near or far variables, you may remove the `DATASEG` and `FARDATA` directives from `CSHELL.ASM`.

Using CSHELL.ASM

`CHSELL` begins by selecting Ideal mode and specifying the small memory model. Change `small` to `tiny`, `medium`, `compact`, `large`, or `huge`, matching the memory model used by your C or C++ program. Notice the absence of `DOSSEG` and `STACK` directives. This allows the compiler and linker to arrange segments as needed by runtime library routines and to specify the stack size, usually 4K unless you change it (see `_stklen` in your C or C++ reference guide).

The shell has three segments: two for data (`DATASEG` and `FARDATA`) and one for code (`CODESEG`). As the comments in the listing indicate, you can declare variables and code `PUBLIC`, thus sharing items in the assembly module with other modules. For example, to create a word integer and export the variable to C or C++, you could insert these lines after `DATASEG`:

```
; In the assembly language module:
PUBLIC _AsmValue
_AsmValue    dw    100
```

The `_AsmValue` label is exported by `PUBLIC` to other modules, including those written in C or C++. A corresponding declaration in the main program tells the compiler about the external variable:

```
/* In the C or C++ program: */
extern int AsmValue;
```

Likewise, a variable in the program can be imported by the assembly language module. All symbols are public in C and C++; therefore, the text just declares a variable normally:

```
/* In the C or C++ program: */
int NewValue;
main()
{
    NewValue = 500;
}
```

Then, in the assembly language module, to import `NewValue`, insert an `EXTRN` directive inside the data segment:

```
DATASEG
EXTRN _NewValue:Word
```

You can now use `_NewValue` in assembly language statements. For example, to copy the value of the imported variable `_NewValue` to the word variable `_AsmValue` declared in the assembly language module, you could use these commands in the code segment:

13

```
CODESEG
mov     ax, [_NewValue]      ; Load variable into ax
mov     [_AsmValue], ax     ; Copy to assembly module variable
```

The code segment (lines 21-50) includes a shell for an external function. Line 32 declares the function name, which should be made public with the line:

```
PUBLIC funcname
```

The shell function is declared `NEAR` (line 32), indicating that the code will be stored in the same segment as the `call` instructions to the function. You can take out or change `NEAR` to `FAR` if you plan to call the function from another segment.

Lines 33-34 and 46 prepare, save, and restore `bp` for addressing function parameters on the stack, using methods explained in a moment. The instructions at lines 36-38 and 42-44 are optional. You need to save and restore `si` and `di` only if these registers are used in the function. Also, you can subtract a value from `sp` to create space for temporary (local) variables (see line 36), later reclaiming this space by assigning `bp` to `sp` (see line 44).

About Underscores

As several of the previous examples show, you must preface all `PUBLIC` and `EXTRN` symbols with underscores. You need to do this only in the assembly language module (not in the C or C++ source) because the compiler adds an underscore to all global symbols unless you are using the `-u` option to compile programs. (Don't use this option unless you're also prepared to recompile the entire C runtime library, which expects global symbols to be underscored.) If you receive "undefined symbol" errors during linking, the cause may be a missing underscore in an assembly language module.

Using Far Data

If you declare variables in a far data segment after the `FARDATA` keyword, you must prepare a segment register to locate the variables in memory. (See chapter 11 for a more complete discussion on this subject.) First, declare your variables after a `FARDATA` directive:

```
FARDATA
_OuterLimits    dw    ?
```

Next, in the code segment, you must prepare a segment register before using the variable. One approach is to use the `SEG` operator to load the address of the far data segment:

```
mov     ax, SEG _OuterLimits ; Address far data segment
mov     es, ax               ; with es
mov     [es:_OuterLimits], dx ; Store dx to variable
```

Or, you can use the predefined `@fardata` symbol:

```
mov     ax, @fardata         ; Address far data segment
mov     es, ax               ; with es
mov     [es:_OuterLimits], dx ; Store dx to variable
```

Sharing Code

Calling assembly language functions is identical to calling C or C++ functions. As an example, Listing 13.4, CFILLSTR.C, declares an external function to fill strings with characters. The example also demonstrates how to replace functions with assembly language. I'll list commands for compiling and assembling CFILLSTR later—as you'll see, there are many ways to proceed.

Listing 13.4. CFILLSTR.C.

```

1: /* Test CFILLSTR External Module -- by Tom Swan */
2:
3: #include <stdio.h>
4: #include <string.h>
5:
6: extern void fillstring(unsigned char far * thestring,
7:   int stringlength, char fillchar);
8:
9: char *test = "Filled to the brim";
10:
11: int main()
12: {
13:   printf("Before fillstring: %s\n", test);
14:   fillstring( test, strlen(test), '@' );
15:   printf("After fillstring: %s\n", test);
16:   return 0;
17: }
18:
19: /*
20: void fillstring( unsigned char far * thestring,
21:   int stringlength, char fillchar )
22: {
23:   int i;
24:
25:   for (i = 0; i < stringlength; i++)
26:     thestring[ i ] = fillchar;
27: }
28: */

```

Compiling CFILLSTR.C

Temporarily delete lines 19 and 28, activating the function at lines 20-27. Later, you'll replace this "pure C" version of the fillstring function with an optimized assembly language module. But first, compile and run the program with the commands:

```
tcc -v cfillstr
cfillstr
```

If you are using Borland C++, enter the following commands (replace bcc with tcc for Turbo C++):

```
bcc -v cfillstr.c
cfillstr
```

Use the `-v` option only if you want to examine the code with Turbo Debugger. If you do that, you may also want to use the `View|CPU` command to examine the machine code for `fillstring`. As Figure 13.1 shows, the compiler's output is impressively tight, but we can still do better. Notice that, unlike inline `asm` statements, only `si` and not `di` is saved and restored, a small improvement. Even so, instructions such as `les` inside the `for` loop are inefficient. The compiler apparently isn't smart enough to realize that `es` isn't changed anywhere else in the loop; therefore, reinitializing the register on each pass is unnecessary.

NOTE

Depending on your version of Turbo C, Turbo C++, or Borland C++, the actual machine code produced may differ from that shown in Figure 13.1.

Calling Assembly Language Functions from C

Replace the comment brackets `/*` and `*/` at lines 19 and 28 in `CFILLSTR.C` if you removed these lines. Then, save Listing 13.5, `CFILL.ASM`, which contains an assembly language version of the `fillstring` function. Instructions for assembling the modules into a finished program follow the listing.

Figure 13.1.
The fillstring function from CFILLSTR.C as disassembled by Turbo Debugger.

```

_fillstring: void fillstring( unsigned char far * thestring,
cs:022c55          push  bp
cs:022D 8BEC      mov   bp,sp
cs:022F 56       push  si
CFILLSTR#37: for (i = 0; i < stringlength; i++)
cs:0230 33F6     xor   si,si
cs:0232 EB0A     jmp   023E
CFILLSTR#38: thestring[ i ] = fillchar;
cs:0234 8A460A   mov   al,[bp + 0A]
cs:0237 C45E04   les  bx,[bp + 04]
cs:023A 268800   mov  es:[bx + si],al
cs:023D 46       inc  si
cs:023E 3B7608   cmp  si,[bp + 08]
cs:0241 7CF1   jnl  CFILLSTR#38 (0234)
CFILLSTR#39:
cs:0243 5E       pop  si
cs:0244 5D       pop  bp
cs:0245 C3       ret

```

Listing 13.5. CFILL.ASM.

```

1: %TITLE "Fill C Strings Demonstration -- by Tom Swan"
2:
3:      IDEAL
4:
5:      MODEL  small
6:

```

```

7:          CODESEG
8:
9:          PUBLIC _fillstring
10:
11: ;-----
12: ; void fillstring( unsigned char far * thestring,
13: ;   int stringlength, char fillchar )
14: ;-----
15: PROC     _fillstring      NEAR
16:
17:         ARG thestring:Dword, stringlength:Word, fillchar:Byte
18:
19:         push    bp                ; Save old bp pointer
20:         mov     bp, sp            ; Address parameters
21:         mov     cx, [stringlength] ; Assign string len to cx
22:         jcxz   @@99              ; Exit if length = 0
23:         push   di                ; Save di
24:         les    di, [thestring]   ; Address string with es:di
25:         mov     al, [fillchar]   ; Assign fill char to al
26:         repnz  stosb             ; Store characters in string
27:         pop    di                ; Restore saved di
28: @@99:
29:         pop    bp                ; Restore saved bp
30:         ret                     ; Return to caller
31: ENDP     _fillstring
32:
33:         END                      ; End of module

```

Assembling and Linking External Modules

You should now have two files on disk, CFILLSTR.C (with the `fillstring` function converted back to a comment) and CFILL.ASM, containing the assembly language replacement for this same function. There are several methods you can use to assemble, compile, and link the separate modules (and similar multiple-file programs) to create the finished .EXE program. The simplest technique is to let Turbo C do all the work:

```
tcc cfillstr cfill.asm
```

If you are using Borland C++, enter the following command (replace `bcc` with `tcc` for Turbo C++):

```
bcc cfillstr.c cfill.asm
```

Either way, the command first compiles CFILLSTR.C to CFILLSTR.OBJ. Then, recognizing the .ASM file-name extension as an assembly language module, the compiler calls Turbo Assembler to assemble CFILL.ASM to CFILL.OBJ. Finally, the compiler calls Turbo Linker to join the object-code modules into CFILLSTR.EXE. When you have only a few modules to compile and assemble, this one-step method is the easiest to use.

NOTE

I purposely did not name the assembly language module in this example CFILLSTR.ASM. If the C program (CFILLSTR.C) has any inline `asm` statements. Or, if you specify the `-B` option or use an early version of Turbo C, the compiler outputs the entire program in assembly language to CFILLSTR.ASM, thus erasing the assembly language text file with no prior warning. For safety, always use different names for your C and assembly language modules. In other words, if your main program file is KERMIT.C, *don't* save your external routines in KERMIT.ASM.

Assembling and Linking Separately

When you have many modules, you'll save time by assembling and linking separately. The first step is to assemble all your .ASM files. Because the `fillstring` example has only one such file, a single command does the job:

```
tasm /ml cfill
```

The `/ml` option turns on case sensitivity, meaning that symbols such as `UpAndDown` and `upanddown` are considered to be different, as they normally are in C and C++ programs. (Turbo Assembler usually ignores case sensitivity, so the `/ml` option is necessary to avoid errors during linking.) After assembling all external modules, compile the main program. Again, this example has only one .C file, so only one command is needed:

```
tcc -c cfillstr
```

Or, with Borland C++, use this command (replace `bcc` with `tcc` for Turbo C++):

```
bcc -c cfillstr.c
```

The `-c` option means "compile only," generating CFILLSTR.OBJ but not linking the program into a finished code file. To include all modules, you have to complete this step yourself, calling Turbo Linker to join the object-code files along with the appropriate runtime library routines to create CFILLSTR.EXE. There are two ways to accomplish this task: the long way and the not-so-long way. Let's cover the more difficult long way first:

```
tlink c:\tc\lib\c0s cfillstr cfill, cfillstr,, c:\tc\lib\cs
```

Edit the pathnames as needed for your installation. For example, using Borland C++ 4, you might use this command:

```
tlink c:\bc4\lib\c0s cfillstr cfill, cfillstr,, c:\bc4\lib\cs
```

The first item after `tLink` specifies an object-code file in the `\LIB` directory for the appropriate memory model, in this case `C0S.OBJ`. (The 0 is a zero; *not* the letter O.) The second and third items list the `.OBJ` code files to link—any order for these files is okay. A comma separates the list of `.OBJ` files from the name to use the finished code file, in this case, `CFILLSTR.EXE`. Two commas then follow, holding a place for an optional map file, not created in this example. Finally, the run-time library is specified, also in the `\LIB` directory.

The `C0S` object-code file and `CS` library file names must match the memory model used by the program. The final letter of these two file names represent one of the models listed in Table 13.2.

Easier Linking

An easier (but slightly less quick) method for linking separate modules is to use the compiler as a “front end” to Turbo Linker. In other words, by giving various compiler commands, you can skip compiling and go straight to linking. Doing this eliminates the need to specify runtime library filenames and, therefore, simplifies the link command. For example, to assemble, compile, and link the `CFILLSTR` demo takes three commands:

```
tasm /ml cfill
tcc -c cfillstr
tcc -ms cfillstr.obj cfill.obj
```

Or, if you are using Borland C++, enter these commands (replace `bcc` with `tcc` for Turbo C++):

```
tasm /ml cfill
bcc -c cfillstr.c
bcc -ms cfillstr.obj cfill.obj
```

The first two commands are the same as described before. The third command calls the compiler a second time, using the `-ms` option to specify a memory model, in this case *small*. (See Table 13.2 for other memory-model option letters.) After the memory-model option are the object-code files to link. Although you must include the `.OBJ` file-name extension with each file, this not-so-long linking method simplifies most of the dirty work of running Turbo Linker directly.

Table 13.2. Runtime Library Filenames.

<i>Memory Model</i>	<i>Object File</i>	<i>Library File</i>	<i>TCC Option</i>
Tiny	C0T.OBJ	CS.LIB	-mt
Small	C0S.OBJ	CS.LIB	-ms
Medium	C0M.OBJ	CM.LIB	-mm
Compact	C0C.OBJ	CL.LIB	-mc
Large	C0L.OBJ	CL.LIB	-ml
Huge	C0H.OBJ	CH.LIB	-mh

Debugging Multilanguage Programs

There are two approaches to debugging programs that mix C or C++ and assembly language. The first method adds debugging information only for C or C++ statements. To do this, compile with the one-step command:

```
bcc -v cfillstr.c cfill.asm
```

This is the same command listed earlier but with a `-v` option added to include debugging information in `CFILLSTR.EXE`. You can then debug the code with:

```
td cfillstr
```

The problem is, this command does not allow you to see your assembly language source code—only C and C++ source lines are listed in the main window. To also see assembly language, you must assemble and link separately, using the more complex methods discussed in the previous section. Using the `CFILL.ASM` and `CFILLSTR.C` examples, the complete steps are:

```
tasm /ml /zi cfill
tcc -c -v cfillstr
tcc -ms -lv cfillstr.obj cfill.obj
```

If you are using Borland C++, enter these commands instead (replace `bcc` with `tcc` for Turbo C++):

```
tasm /ml /zi cfill
bcc -c -v cfillstr.c
bcc -ms -lv cfillstr.obj cfill.obj
```

First, `CFILL.ASM` is assembled, using the `/ml` option to switch on case sensitivity and `/zi` to include debugging information in `CFILL.OBJ`. Next, the compiler compiles `CFILLSTR.C`, specifying compilation only (`-c`) and adding more debugging information to `CFILLSTR.OBJ` (`-v`). Finally, the compiler is called into service as a front end for Turbo Linker. The `-ms` option selects an appropriate memory model. The `-lv` option passes an option letter, in this case `v`, to Turbo Linker so that all of the debugging information in both `CFILLSTR.OBJ` and `CFILL.OBJ` is transferred to the finished code file `CFILLSTR.EXE`. The result can then be loaded into Turbo Debugger with:

```
td cfillstr
```

If you try this, press `F7` repeatedly to step through the program. When you get to call to `fillstring`, Turbo Debugger switches to the assembly language source, letting you step through the individual instructions in the external module. When the assembly language module finishes, you again see the program's source code. (Of course, for this to work, both `CFILLSTR.C` and `CFILL.ASM` must be in the current directory.)

How CFILLSTR.C and CFILL.ASM Work

Now that you know how to assemble, compile, and link multiple modules in assembly language and C or C++, let's take a closer look at how the two files work together. First, examine CFILLSTR.C (Listing 13.4) lines 6-7, which declare function `fillstring` external, using the `extern` directive. This allows the compiler to determine that the code for the call to `fillstring` at line 14 will be supplied later. (If it isn't, Turbo Linker displays an error.)

Listing 13.5, CFILL.ASM, replaces the `fillstring` function with an assembly language module. Line 9 declares `_fillstring` to be public, adding an underscore to conform with the C and C++ rule for all global symbols. Inside the function, an `ARG` directive (line 17) simplifies addressing parameters passed on the stack. Without `ARG`, you'd have to calculate offsets from `bp` and use instructions such as:

```
mov    cx, [bp + 6]
```

assuming, that is, that the parameter you want is 6 bytes ahead of where `ss:bp` points. Instead of using this error-prone method, `ARG` lets you list the function parameters in the same order that the identifiers appear in the function prototype (see lines 12-13). For each parameter separated by commas, list the name and size, using one of the size qualifiers from Table 13.1, but without the `ptr` suffix. Using `ARG` this way allows lines 21 and 24-25 to refer to parameters by name. Of course, you still have to be careful to specify the correct sizes for your variables.

After loading the appropriate registers, line 26 uses a repeated string instruction to store the requested number of characters into the string. No checks are made on this length—so be careful, or you'll overwrite other items in memory. Compare this with the compiled code in Figure 13.1 for the pure C version of `fillstring`. It doesn't take much detective work to know that a single string instruction runs faster than the C for loop, which takes eight assembly language instructions.

The assembly language `fillstring` also preserves register `di` just in case a register variable is being used by another function that calls `fillstring`. But notice how lines 23 and 27 postpone saving and restoring `di` until after the previous code checks the string length and exits if the length is 0 (lines 21-22). Although this may be a minor improvement, it could reduce running times if `fillstring` is called frequently with zero-length strings.

Calling C Functions from Assembly Language

So far, you've learned how to share variables between C or C++ and assembly language and how to call external assembly language functions from a C or C++ program. Going the other direction—that is, calling a C or C++ function from an assembly language module—is also possible, but it requires care to accomplish properly.

If the function has no parameters, the process is simple. Just declare the C or C++ function in an `EXTRN` directive and use a `call` instruction:

```
CODESEG
EXTRN _cfunction:proc
...
call _cfunction
```

This assumes that a function named `cfunction` exists in the program to be linked with the assembly language module. Once again, an underscore is added in the assembly language declaration (but not in the C or C++ text).

When functions require parameters, the process becomes more difficult. Simple parameters such as characters and integers are often passed directly on the stack. Complex variables such as strings, structures, and arrays are passed by reference, that is, by address. Also, many functions return results in specific registers. When calling C or C++ functions from assembly language, it's your responsibility to take care of these details.

First, let's look at the simplest case, calling a function with one integer parameter:

```
void showscore( int thescore )
{
    printf("\nThe score is: %d\n", thescore);
}
```

From inside an assembly language module, to call the `showscore` function, passing the value of a word variable as `thescore`, you can write:

```
CODESEG
EXTRN _showscore:proc
mov     ax, 76          ; Assign score to a register
push   ax              ; Pass parameter on stack
call   _showscore     ; Call the C function
pop    ax              ; Fix the stack
```

First, a sample score is assigned to `ax` (any other registers would do as well), which is then pushed onto the stack before calling `_showscore`. After returning from the function, a word is popped from the stack. This is required because in C and C++ it is the caller's responsibility to remove parameters from the stack. (If you read chapter 12, you'll recall that, in Pascal, procedures and functions take care of removing stacked parameters before returning.) When you have several parameters, it may be better just to add the total number of bytes to `sp`. For example, to call a function that takes four 16-bit parameters, you might use:

```
push   [v1]           ; Push four word variables (not shown)
push   [v2]           ; onto the stack
push   [v3]
push   [v4]
call   _aCfunction    ; Call a C function
add    sp, 8          ; Remove parameters
```

Push multiple parameters in the *reverse* order in which they are declared in the C or C++ function. Assuming the `fillstring` function is defined as:

```
void fillstring( unsigned char far * the string,
               int stringLength, char fillchar );
```

to call this function from assembly language and fill a string variable with blanks, requires several steps. First, the assembly language module declares a string variable:

```
DATASEG
PUBLIC _astring
_astring    db      80 dup (0)
```

Then, the same module declares `_fillstring` in an `EXTRN` directive and calls the function to fill the string variable with blanks:

```
CODESEG
EXTRN _fillstring:proc
...
xor    ah, ah          ; Zero upper half of ax
mov    al, ' '         ; Assign blank char to al
push  ax              ; Push fillchar parameter
mov    ax, 79         ; Assign string Length to ax
push  ax              ; Push stringLength parameter
push  ds              ; Push segment of string address
mov    ax, offset _astring ; Assign offset address to ax
push  ax              ; Push offset of string address
call  _fillstring     ; Call the function
add   sp, 8          ; Remove parameters from stack
```

Each parameter—the fill character, string length, and 32-bit pointer to the string variable—is pushed onto the stack in the reverse order as listed in the function definition. In the case of the pointer, the segment address `ds` is pushed before the offset. After the call to `_fillstring`, 8 bytes are added to the stack pointer `sp`, removing the parameters from the stack.

Even though in this example the `_fillstring` function is actually written in assembly language, calling pure C and C++ functions is no different. When you are not sure about exactly how to call a library routine (the ubiquitous `printf()`, for example), run a test program in Turbo Debugger and examine the compiled machine code. This will tell you what parameters are required and will also give you many new insights into how compilers convert C and C++ statements to assembly language—knowledge that you can use for your own external modules.

Function Results

Many C and C++ functions return values in registers or, in the case of `float`, `double` and `long double` values, in the math coprocessor top of stack (`st(0)`). Table 13.3 lists the registers used to return various data types. All 8-bit types are returned in `al`; 16-bit types, in `ax`; and 32-bit types, in `dx:ax`, with the low-order portion of the value (for example, the offset of a pointer in `ax`).

Table 13.3. Function Result Types.

<i>Data Type</i>	<i>Bytes</i>	<i>Register(s)</i>
Unsigned char	1	al
Char	1	al
Enum	2	ax
Unsigned short	2	ax
Short	2	ax
Unsigned int	2	ax
Int	2	ax
Unsigned long	4	dx:ax
Long	4	dx:ax
Float	4	st(0) (8087 stack)
Double	8	st(0) (8087 stack)
Long double	10	st(0) (8087 stack)
Near *	2	ax
Far *	4	dx:ax

LOCAL Variables

In addition to variables declared in the data segment or shared with a C or C++ program, you can also use local variables on the stack in your assembly language modules. A local variable exists only while the function runs. Stack space is created for the variable at the start of the function and is then reclaimed before the function ends. The way, other functions can share the same memory for their own local variables, cutting down on the program's total memory requirements. You probably know how to declare local variables in C and C++ functions, for example, as control variables in a for loop:

```
void countup()
{
    int i;
    for (i = 0; i < 10; i++)
        printer( "%d ", i );
}
```

Integer variable *i* is allocated memory on the stack at the start of the `countup` function and exists only while the function runs. You can do the same in an assembly language module with a `LOCAL` directive. Here's an example of a complete function:

```
PROC    _cfunction    NEAR
        LOCAL i:Word =stacksize
        push    bp
        mov     bp, sp
```

```

        sub    sp, stacksize
        mov    [i], 0
@@10:
        inc    [i]
;
;----- Code to use Local variable [i]
;
        cmp    [i], 10
        jne    @@10
        mov    sp, bp
        pop    bp
        ret                                ; Return to caller
ENDP    _cfunction

```

The `LOCAL` directive in this example prepares a variable `i` of type `word`. The `=stacksize` is assigned the total number of bytes occupied by all local variables—in this case, 2 bytes. This value is subtracted from `sp` after preparing to address variables on the stack. Then, to refer to `i`, use instructions such as `mov`, `inc`, and `cmp`. Because of the `LOCAL` directive, references such as `[i]` are translated into:

```

mov    [bp - 2], 0
inc    [bp - 2]

```

and so on. With `LOCAL`, you don't have to calculate the negative offsets from `bp` to locate variables on the stack—you can just use the variable names.

Notice the `mov sp, bp` instruction just before this sample function restores `bp`. Because `bp` doesn't change during the function, you can reset `sp` from `bp`, removing the local variable space from the stack, or you can add `stacksize` to `sp` with:

```
add    sp, stacksize
```

Either method works, but restoring `sp` from `bp` is faster. You can also declare multiple local variables with statements such as:

```
LOCAL i:Word; j:Word; c:Byte =stacksize
```

You can then use the three local variables `i`, `j`, and `c`, after subtracting `stacksize` from the stack pointer to reserve space on the stack. (You must always do this. `LOCAL` simplifies addressing local variables; it doesn't create space for the variables in memory.)

NOTE

I included local variables in this section because you should know how to use them. But remember that one of the reasons compiled C and C++ programs can run slowly is that addressing local variables takes time. The same is true for Pascal and other languages. One of the motives behind adding assembly language to high-level language code is to squeeze as much speed as possible into a program. And, one way to do that is to store variables in fast processor registers instead of on the stack. The morale is: Don't use techniques that seem interesting; go for the techniques that give you the speed gains you're after.

Calling C++ Functions from Assembly Language

C++ extends the C language with object-oriented classes and some additional syntax rules that, in general, help programmers write more reliable code. All of the preceding information on mixing C and assembly language applies equally well to C++, but there are a few curveballs you need to know about—don't let them throw you.

This section explains how to mix C++ and assembly language, and also demonstrates how to interface assembly modules with C++ classes. You must have Turbo C++ or Borland C++ to compile the programs. I used Borland C++ and Turbo Assembler versions 4.0 and 4.5 to test all programs in this section.

Name Mangling

C++ permits function-name overloading, meaning that two different functions may have the same names provided they differ in at least one parameter. This programming device is handy, but it poses a problem for common linkers. So that linkers can distinguish between multiple functions that have the same names, C++ *mangles* their names by combining them with their parameters. The result is a new, though unpronounceable, name that is unique for all of a module's functions.

An example shows what mangled names look like. As you may know, using C++ I/O streams, you can write a string and start a new line with the following statement:

```
cout << "Write me to the standard output" << endl;
```

The `endl` manipulator sends a carriage return and line feed to the standard output. When you link this program to the I/O stream library, C++ mangles the `endl` identifier, passing the following declaration to the linker:

```
extrn @endl$qr7ostream:near
```

The symbol `@endl$qr7ostream` is the mangled function name, which the compiler creates using an unspecified algorithm. By the way, I found this name by compiling a C++ test program with the `-S` option and then inspecting the resulting `.ASM` text file.

Unfortunately, mangled function names create a major problem for programmers who need to combine C++ and assembly language. To interface with C++ modules, you have two choices:

1. Compile your C++ modules to `.ASM` text files, and copy the mangled names for use in assembly language modules.
2. Disable name mangling for C++ functions called from assembly language, or for subroutines called from C++.

The second option is usually best, although this choice is not always practical. You might, for example, have to interface with an existing C++ function library, or you might have to interface with overloaded functions. In those cases, you will have to compile the C++ code to discover the mangled names, which you can use in `EXTRN` directives in your assembly language modules as explained in this chapter. This will make your programs highly unportable, as the name mangling algorithm could very well change in future compiler versions.

Most times, however, it is best to disable name mangling when mixing assembly language and C++. Listings 13.6, `CPPFUNC.CPP` and 13.7, `CPPLOOP.ASM`, show the basic techniques. I'll explain how the program works after the listings. Compile, assemble, link, and run it with these commands (replace `bcc` with `tcc` for Turbo C++):

```
bcc -c cppfunc
tasm /ml cpploop
bcc cppfunc.obj cpploop.obj
cppfunc
```

Running the program displays the following three lines:

```
Welcome to C++ and Assembly Language
@@@@@@@@@@@@@@@@@@@@@@@@@@@@@@@@@@@@@@@@
That's all folks!
```

Listing 13.6. `CPPFUNC.CPP`.

```
1: // Calling C++ and assembly language functions -- by Tom Swan
2:
3: #include <iostream.h>
4:
5: extern "C" void Loop(); // Prototype function in asm module
6: extern "C" void Terminate(); // Prototype function in C++ module
7: extern int len; // Declare data in asm module
8: char c; // Define global data in C++ module
9:
10: int main()
11: {
12: cout << "Welcome to C++ and Assembly Language" << endl;
13:
14: c = '@'; // Assign value to C++ global data
15: len = 40; // Assign value to asm module data
16: Loop(); // Call asm module function
17: return 0; // End program
18: }
19:
20: // Function called by external loop() in asm module
21: extern "C"
22: void Terminate()
23: {
24: cout << endl << "That's all folks!" << endl;
25: }
```

Listing 13.7. CPPLOOP.ASM.

```

1: %TITLE "C++ and Assembly Language External Function -- by Tom Swan"
2:
3:     IDEAL
4:     MODEL    small
5:
6: ;----- Data segment
7:
8:     DATASEG
9:
10:    EXTRN    _c:BYTE           ; Data declared in C++ module
11:    _len    DW      0           ; Data declared in asm module
12:    PUBLIC   _len             ; Make data available to C++
13:
14: ;----- Code segment
15:
16:    CODESEG
17:
18:    EXTRN    _Terminate:PROC ; Function in C++ module
19:    PUBLIC   _Loop           ; Function in asm module
20:
21: ;-----
22: ; void Loop();
23: ;-----
24: PROC     _Loop                NEAR
25:     mov     cx, [_len]         ; Get length from asm module
26:     jcxz    @@99              ; Exit if length = 0
27: @@10:
28:     mov     ah, 2             ; Select DOS output function 2
29:     mov     dl, [_c]          ; Get character from C++ module
30:     int     21h              ; Call DOS to output character
31:     loop    @@10             ; Loop on cx
32: @@99:
33:     call    _Terminate        ; Call function in C++ module
34:     ret
35: ENDP    _Loop
36:
37:     END                      ; End of module

```

Calling Assembly Language Functions from C++

To call an assembly language function from a C++ module, declare the function prototype as you would for pure C++ code, but precede it with `extern "C"` as shown at line 5 in `CPPFUNC.CPP`:

```
extern "C" void Loop();
```

This declares a function named `Loop` that returns no value. The `extern` preface tells the compiler that the function's implementation is located in another module (the compiler doesn't need to know that the function will be written in another language). The quoted `"C"` turns

off name mangling so that you can use the symbol `_Loop` in the assembly language module instead of the mangled name. (You still must add a leading underscore as shown, however.)

Line 16 in the C++ module calls `Loop`. The assembly language module, `CPPLOOP.ASM`, provides that function's implementation. So the linker can join both modules, the assembly language module makes `_Loop` (with a leading underscore) public at line 19. The function itself at lines 24-35 implements the function's actions. (For test purposes, the function outputs a character a specified number of times. This produces the row of `@` symbols you see when you run the program.)

Multiple External Functions

When declaring multiple external assembly language functions, you can use individual `extern` declarations as in the sample listing, or you can encase multiple declarations in braces. For example, you can declare three functions like this:

```
extern "C" void f1();
extern "C" void f2();
extern "C" void f3();
```

Or, you can use a single `extern` declaration, and list each function in braces:

```
extern "C" {
    void f1();
    void f2();
    void f3();
}
```

The two formats produce the same results: three functions, `f1`, `f2`, and `f3`, with unmangled names. In the assembly language module, you can refer to these functions by adding leading underscores, as in `_f1`, `_f2`, and `_f3`.

Calling C++ Functions from Assembly Language

Calling a C++ function from an assembly language module poses the same problem with name mangling. For simplicity, it's usually best to turn off name mangling using the same technique outlined in the preceding sections. Listing 13.6, `CPPFUNC.CPP`, shows a sample declaration at line 6:

```
extern "C" void Terminate();
```

Despite the fact that the function is declared `extern`, it is implemented at lines 21-25. This may seem odd, but remember that the compiler doesn't care how functions are implemented. An "external" function can be written in another module in C++, assembly language, or any other language. External functions can also be written in the *same* module in which they are declared as shown here. The `extern` declaration merely tells the compiler not to expect a function to be implemented in the current module—there is no prohibition in doing so, however. The only reason for using `extern` in this case is to disable name mangling.

Notice that in the function's implementation, you must repeat the `extern "C"` preface (see line 21). This preface is part of the function prototype, and therefore, it must be repeated in the function's implementation. The test function, `Terminate`, displays a message before the program ends.

The C++ module does not call `Terminate`. That happens in the assembly language module `CPPLOOP.ASM`. Because the function exists in another module, the first step is to declare it `EXTRN` in the module's code segment as shown at line 18:

```
EXTRN _Terminate:PROC
```

NOTE

Use the `EXTRN` (no E) directive in assembly language. Use the `extern` (with e) directive in C++.

The `EXTRN` directive specifies a function (`PROC`) named `_Terminate` that exists in another module. The assembler doesn't need to know how that function is implemented—only that it doesn't exist in the current module. Declaring the function external permits the program to call it as line 33 demonstrates. This is all you need to do to call a C++ function from an assembly language module. There are some additional complications, however, when you need to pass arguments back and forth between C++ and assembly language functions. I'll attack those problems a bit later.

Mixing Global Data

The `CPPFUNC.CPP` and `CPPLOOP.ASM` listings also demonstrate how to access global data in C++ and assembly language modules. The demonstration program uses two global variables—an `int` value `len` and a `char` variable `c`. The assembly language `Loop` function displays the specified character `len` times.

Just to keep things interesting, I defined the `len` variable in the assembly language module. I defined the character in the C++ code. Each module declares both symbols so that both modules may access the program's global data.

NOTE

To *declare* a symbol merely gives it a name and a type. To *define* a symbol allocates storage for an object to which the symbol refers. The distinction between *declaring* and *defining* can be important especially when programming with mixed languages in multiple modules. For example, you *declare* a symbol externally in one module so that you can access that symbol's defined object in another module. Most important, many modules can *declare* the same symbol (as long as they do so identically), but only one module can *define* an object's storage.

Listing 13.8 .CPPARG.CPP.

```

1: // Pass arguments to/from assembly language -- By Tom Swan
2:
3: #include <iostream.h>
4:
5: extern "C" void CPPFunction(char c, int k);
6: extern "C" void ASMFunction(char c, int k);
7:
8: int main()
9: {
10:  CPPFunction('x', 10); // Call C++ function
11:  ASMFunction('y', 20); // Call ASM function
12:  return 0;
13: }
14:
15: // Function called by C++ and asm modules
16: extern "C"
17: void CPPFunction(char c, int k)
18: {
19:  for (int i = 0; i < k; i++)
20:    cout << c;
21:  cout << endl;
22: }

```

Listing 13.9. ASMARG.ASM.

```

1: %TITLE "C++ and Assembly Language Arguments -- by Tom Swan"
2:
3:      IDEAL
4:      MODEL  small
5:
6: ;----- Equates
7:
8: cr    EQU    13      ; Carriage return
9: lf    EQU    10      ; Line feed
10:
11: ;----- Code segment
12:
13:      CODESEG
14:
15:      EXTRN  _CPPFunction:PROC ; Function in C++ module
16:      PUBLIC _ASMFunction    ; Function in asm module
17:
18: ;-----
19: ; void ASMFunction(char c, int k);
20: ;-----
21: PROC  _ASMFunction  NEAR
22:
23:      ARG c_offset:byte, k_offset:word
24:
25:      push  bp          ; Save caller's bp
26:      mov   bp, sp      ; Set up for addressing arguments
27:      mov   cx, [k_offset] ; Get loop count (k)

```

```

28:      jcxz   @@99          ; Exit if k == 0
29: @@10:
30:      mov    ah, 2          ; Select DOS output function 2
31:      mov    dl, [c_offset] ; Get character (c) to display
32:      int    21h           ; Call DOS to output character
33:      loop   @@10         ; Loop on cx
34:      mov    dl, cr        ; Output carriage return
35:      int    21h           ;
36:      mov    dl, lf        ; Output line feed
37:      int    21h           ;
38: @@99:
39:      mov    ax, 30         ; Push count argument
40:      push   ax            ; onto stack
41:      mov    al, 'z'       ; Push character argument
42:      push   ax            ; onto stack
43:      call   _CPPFunction  ; Call C++ function & pass args
44:      add    sp, 4         ; Adjust stack on return
45:
46:      pop    bp            ; Restore caller's bp
47:      ret                    ; Return to caller
48: ENDP   _ASMFunction
49:
50:      END                  ; End of module

```

Passing Arguments from C++ to Assembly Language

The demonstration program uses two functions, `CPPFunction` (defined in the C++ module) and `ASMFunction` (defined in the assembly language module). As before, each function is declared with `extern "C"` to disable name mangling, and in the case of `ASMFunction`, to designate that this function's implementation is in a separate module.

NOTE

As with data objects, you *declare* a function merely to give it a name, a return type, and to list any parameters. You *define* a function when you write its statements. The distinction is important because you may declare a function in many modules, but you may define it only once.

Even though the functions are written differently, as lines 10-11 show, they are used identically. It doesn't matter to C++ how you implement your functions.

The two functions perform the identical task—writing a certain number of characters to the standard output file. `CPPFunction` is written in C++; `ASMFunction` is written in assembly language. Unlike the earlier demonstration that used global data, the new functions receive arguments on the stack. Lines 10-11 pass character and length arguments to the functions.

Function `ASMFunction` in the assembly language module, `ASMARG.ASM`, obtains its function arguments using an `ARG` directive following the procedure header (line 23). The arguments are listed in the same order as they are in the C++ function prototype:

```
ARG c_offset:byte, k_offset:word
```

Arguments declared this way are not data objects; they are offsets from register `bp` into the stack. Using `ARG` this way lets the assembler calculate the offsets for you—but you must specify the correct data types. A `char` variable in C++ is a byte in assembly language; a C++ `int` is equivalent to an assembly language word, and so on.

Lines 27 and 31 show how to load the parameters into registers. For these statements to work, however, you must preserve and prepare register `bp` as shown at lines 25-26. These instructions save `bp`'s current value, and then set `bp` to the current stack pointer. The assembly language program can then use the `ARG` offsets, `c_offset` and `k_offset`, to access the passed arguments.

Remember to restore `bp`'s saved value as shown at line 46 before returning from the assembly language function.

Passing Arguments from Assembly Language to C++

The reverse process—passing arguments from assembly language to C++—requires a different strategy. In the sample program, line 43 calls `_CPPFunction` in the C++ module. That function expects to receive two arguments, which the assembly language module provides by pushing values onto the stack.

This is simple enough to do as lines 39-42 demonstrate, but be sure to push the values in the correct order. Push the rightmost argument first, and you can't go wrong. For example, lines 39-40 push the integer `len` value; lines 41-42 push the character. This order is the reverse in which the arguments are declared in the function prototype (see `CPPARG.CPP` line 5).

NOTE

Even though the character argument requires a byte of storage, the program pushes a word onto the stack at line 40. It isn't possible to push a single byte onto the stack.

There's one other vital step that you must not forget. Because C++ functions do not clean up their own stacks, you must delete the pushed arguments after calling the C++ function. Line 44 in the assembly language module, `ASMARG.ASM`, shows how to perform this essential task. You could `pop` the pushed values, but it's easier just to add the appropriate value to the stack pointer. (Be sure to calculate the correct size. Because the program pushes two words, the sample code subtracts four bytes from `sp`.)

Declaring Procedure Arguments Automatically

By using an alternate form of the `PROC` directive, you can simplify the job of receiving arguments passed by a C++ statement to assembly language functions. The end results are the same, but you might want to compare the two techniques and choose the one that suits your tastes. The method shown here eliminates the need to prepare and restore register `bp`, but is otherwise the same as the preceding technique.

Listing 13.10, `ASMARG2.ASM`, replaces `ASMARG.ASM`. First compile, assemble, and link the listings as explained in the preceding section, and then assemble and bind the new module using these commands (replace `bcc` with `tcc` for Turbo C++):

```
tasm /ml asmarg2
bcc -ecpparg2.exe cpparg.obj asmarg2.obj
cpparg2
```

Running the `CPPARG2.EXE` program produces the same output as the original demonstration.

Listing 13.10. `ASMARG2.ASM`.

```
1: %TITLE "C++ Arguments Part 2 -- by Tom Swan"
2:
3:     IDEAL
4:     MODEL    small
5:
6: ;----- Equates
7:
8: cr    EQU    13      ; Carriage return
9: lf    EQU    10      ; Line feed
10:
11: ;----- Code segment
12:
13:     CODESEG
14:
15:     EXTRN  _CPPFunction:PROC ; Function in C++ module
16:     PUBLIC _ASMFunction    ; Function in asm module
17:
18: ;-----
19: ; void ASMFunction(char c, int k);
20: ;-----
21: PROC    _ASMFunction C c_arg:byte, k_arg:word
22:
23:     mov    cx, [k_arg]      ; Get argument k
24:     jcxz  @@99              ; Exit if k == 0
25: @@10:
26:     mov    ah, 2            ; Select DOS output function 2
27:     mov    dl, [c_arg]      ; Get character to display
28:     int    21h              ; Call DOS to output character
29:     loop  @@10              ; Loop on cx
30:     mov    dl, cr           ; Output carriage return
31:     int    21h
```

continues

Listing 13.10. continued

```

32:      mov    d1, 1f          ; Output line feed
33:      int    21h
34: @@99:
35:      mov    ax, 30          ; Push count argument
36:      push   ax              ; onto stack
37:      mov    al, 'z'         ; Push character argument
38:      push   ax              ; onto stack
39:      call  _CPPFunction    ; Call C++ function & pass args
40:      add    sp, 4           ; Adjust stack on return
41:
42:      ret                    ; Return to caller
43: ENDP  _ASMFunction
44:
45:      END                    ; End of module

```

At line 21, the modified listing declares `_ASMFunction` and its arguments with single directive:

```
PROC    _ASMFunction C c_arg:byte, k_arg:word
```

The `C` after the function name specifies that arguments are for the C language (that is, they are pushed onto the stack in right to left order). The remainder of the line is the same as for an `ARG` directive.

The result, however, is that Turbo Assembler automatically writes instructions to save, initialize, and restore `bp`. *When using this alternate technique, do not push and pop `bp` explicitly.* Except for this change, the other programming remains the same.

Mixing C++ Classes with Assembly Language

One of the main reasons for using C++ is to write object-oriented programs with classes. Adding assembly language to OOP code, however, is extremely difficult for several reasons:

- The internal formats of class objects, member functions, and especially virtual functions, depend on the compiler's implementation. These formats, some of which are obscure or poorly documented, may also differ between compiler versions.
- Unlike plain C++ functions, you cannot disable name mangling for C++ classes and member functions. Technically, you might be able to do this in limited cases, but because overloaded names are essential to the techniques of C++ programming, it isn't practical to disable name mangling for object-oriented code. This makes referring to class and member function names in assembly language extremely difficult because you have to do so by writing mangled names.
- Numerous C++ features such as exception handling, multiple inheritance, operator overloading, and other programming methods that C++ programmers take for granted demand utmost skill to accomplish in assembly language.

- Because the C++ language continues to evolve, anything you write today might be out of date by the time you assemble your code. Writing portable assembly language interfaces to C++ is, for all practical purposes, an impossible dream.

So, what is the solution? As every quarterback knows, the answer is simple: *When you can't go forward, punt.*

Creating the C++ Class

Listing 13.11, CPPOOP.CPP, demonstrates the first step of a simple method for mixing C++ classes, object-oriented programming, and assembly language. The technique is guaranteed to work with all versions of C++, and is fully portable (except, of course, for the assembly language code itself).

As I've suggested elsewhere in this book, when mixing languages, it's usually best to write the high-level code first and then, after you get the program working, convert selected functions to assembly language.

In this case, however, because it is so difficult to interface directly with assembly language from C++, a different strategy is called for in the form of additional functions that serve as an interface between a class and the assembly language module. Class member functions call these extra functions, which in turn call the assembly language code. Although this method adds one extra function call, and thus reduces the advantage of using assembly language somewhat (though not a great deal), the resulting programming is easy to write and maintain.

Compile, assemble, link, and run the sample listings with the following commands (replace `bcc` with `tcc` for Turbo C++):

```
bcc -c cppoop
tasm /ml asmfill
bcc cppoop.obj asmfill.obj
cppoop
```

Running the demonstration program displays the following lines:

```
Buffer : b1, size = 10 byte(s)
Contents: @@@@@@@@@@

Buffer : b2, size = 15 byte(s)
Contents: #####

Buffer : b3, size = 25 byte(s)
Contents: *****

Buffer : b1, size = 10 byte(s)
Contents: 1111111111

Buffer : b2, size = 15 byte(s)
Contents: 222222222222222

Buffer : b3, size = 25 byte(s)
Contents: 33333333333333333333333333333333
```

For demonstration purposes, the sample program declares a class, `TBuffer`, for creating buffer objects filled with specified byte values. The program displays the size of each buffer, which is dynamically created and managed by the class using the C++ `new` operator. The assembly language module fills the class object buffers using a fast string instruction loop. To do that, the assembly language module must call the buffer objects' class member functions to determine the size of the buffer and the fill character to use. These actions also demonstrate how to pass class objects between assembly language and C++ modules.

Listing 13.11, `CPPOOP.CPP`, is the first listing. It declares and implements the `TBuffer` class, and also prepares an interface for the assembly language module.

Listing 13.11. CPPOOP.CPP.

```

1: // Object--oriented C++ and assembly language -- by Tom Swan
2:
3: #include <iostream.h>
4:
5: class TBuffer {
6:
7: // Constructor and destructor
8: public:
9:   TBuffer(char c, int bs);
10:  ~TBuffer();
11:
12: // Member functions
13: public:
14:   void SetFillChar(char c)
15:     { fillChar = c; }
16:   char GetFillChar()
17:     { return fillChar; }
18:   int GetFillSize()
19:     { return fillSize; }
20:   void FillBuffer();
21:   void ShowBuffer(const char *s);
22:
23: // Private data members
24: private:
25:   char fillChar;      // Character to insert in buffer
26:   int fillSize;      // Size of buffer in bytes
27:   char far *buffer;  // Pointer to buffer
28: };
29:
30: // External asm module function declaration
31: extern "C" void ASMFillBuffer(TBuffer far &bo, char far *buffer);
32:
33: // External cpp module function declarations
34: extern "C" char CPPGetFillChar(TBuffer &bo);
35: extern "C" int CPPGetFillSize(TBuffer &bo);
36:
37: int main()
38: {
39:   TBuffer b1('@', 10); // Construct objects

```

```

40:  TBuffer b2('#', 15);
41:  TBuffer b3('*', 25);
42:
43:  b1.ShowBuffer("b1"); // Display object buffers
44:  b2.ShowBuffer("b2");
45:  b3.ShowBuffer("b3");
46:
47:  b1.SetFillChar('1'); // Set fill chars and refill buffer
48:  b1.FillBuffer();
49:  b2.SetFillChar('2');
50:  b2.FillBuffer();
51:  b3.SetFillChar('3');
52:  b3.FillBuffer();
53:
54:  b1.ShowBuffer("b1"); // Display object buffers
55:  b2.ShowBuffer("b2");
56:  b3.ShowBuffer("b3");
57:
58:  return 0;           // End program
59: }
60:
61: // Implement TBuffer constructor
62: TBuffer::TBuffer(char c, int bs)
63: {
64:     fillChar = c;           // Save fill character
65:     fillSize = bs;         // Save buffer size
66:     buffer = 0;            // Initialize buffer pointer
67:     if (fillSize <= 0) return; // Exit if size is <= zero
68:     buffer = new char[fillSize]; // Allocate memory for buffer
69:     FillBuffer();          // Fill buffer with characters
70: }
71:
72: // Implement TBuffer destructor
73: TBuffer::~TBuffer()
74: {
75:     delete buffer; // Dispose of allocated memory
76: }
77:
78: // Implement fill-buffer member function
79: // Calls external assembly language function
80: void TBuffer::FillBuffer()
81: {
82:     ASMFillBuffer(*this, buffer); // Call function in asm module
83:
84: /* C++ equivalent code for above function call
85:    if (buffer == 0) return;
86:    for (int i = 0; i < GetFillSize(); i++)
87:        buffer[i] = GetFillChar();
88: */
89: }
90:
91: // Implement show-buffer member function
92: void TBuffer::ShowBuffer(const char *s)
93: {
94:     cout << endl;
95:     cout << "Buffer : " << s;

```

Listing 13.11. continued

```

96:  cout << ", size = " << GetFillSize() << " byte(s)" << endl;
97:  cout << "Contents: ";
98:  for (int i = 0; i < GetFillSize(); i++)
99:      cout << buffer[i];
100: cout << endl;
101: }
102:
103: // Return fill character for object bo
104: // Called by external asm function
105: extern "C"
106: char CPPGetFillChar(TBuffer &bo)
107: {
108:     return bo.GetFillChar();
109: }
110:
111: // Return buffer size for object bo
112: // Called by external asm function
113: extern "C"
114: int CPPGetFillSize(TBuffer &bo)
115: {
116:     return bo.GetFillSize();
117: }

```

Lines 5-28 declare the `TBuffer` class. This is pure C++. Notice that some member functions are implemented inline (lines 14-19), and others are implemented normally (lines 20-21). With the interfacing technique explained here, member functions could also be virtual, although none is in this example. You may also use multiple inheritance and all other C++ programming methods.

Lines 30-31 declare an external assembly language function that the `TBuffer` class uses. This function is declared with an `extern "C"` directive, just as in the preceding examples. In addition to turning off name mangling for the `ASMFULLBuffer` function name, the designation also tells the compiler that the function's implementation is in a separate module.

Two other C++ functions are similarly declared at lines 34-35. The assembly language module calls these functions to obtain data members from a `TBuffer` class object.

QUICK REVIEW

Line 31 declares an assembly language function to be called *from* C++. Lines 34-35 declare C++ functions to be called *from* assembly language. Despite their different uses, the declarations are identical in form.

Closely examine the arguments in these three functions. The first argument in each case is a reference to a `TBuffer` object. This demonstrates one way to pass class objects to and from assembly language modules. You may pass other arguments as well. For example,

`ASMFillBuffer` receives a pointer to a char buffer—the destination that the assembly language module fills.

The `main` function creates three `TBuffer` objects (lines 39-41), filled with different characters in variously sized buffers. Lines 43-45 call a class member function to display the buffer contents. Lines 47-52 change the fill character and call another member function to refill the buffer. Lines 54-56 again display the buffers' contents.

At lines 62-70, the class constructor allocates memory for a buffer using the `new` operator (see line 68). The constructor calls `FillBuffer` to fill the allocated memory with the designated character.

A destructor at lines 73-76 deletes the memory allocated by the constructor to `TBuffer` objects.

Following the constructor and destructor are the implementations of the `TBuffer` class member functions. The first such function, `FillBuffer`, shows how the class interfaces with the assembly language module. Line 82 calls the assembly language function, `ASMFillBuffer`, to perform the actions for the `FillBuffer` member function.

In other words, rather than replace `TBuffer::FillBuffer` directly with assembly language, the program simply calls the assembly language module from inside the class member function. There is one complication, however—you must pass the object *address* to the assembly module so that the function can obtain data and call other functions related to that object. To do that, pass an object's address as `*this` as shown to a reference parameter. (If you prefer, instead of a reference, you can pass an object pointer. In that case, pass `this` without dereferencing it.)

For comparison, lines 85-87 list the C++ equivalent code for the `ASMFillBuffer` function. Notice that the C++ code calls two member functions, `GetFillSize` and `GetFillChar`, to obtain the buffer size and fill character. This is simply good OOP technique. The class's data members are private, and are accessed strictly by calling member functions. Writing assembly language code to do the same, however, requires a bit of extra effort as you will learn in the next listing.

First, however, let's finish explaining the C++ code. Lines 92-101 implement the `ShowBuffer` member function, which displays the buffer contents. There's no assembly language here.

Lines 105-117 implement two functions that the assembly language module calls. These functions represent the interface between the assembly language code and the C++ `TBuffer` class. Function number one, `CPPGetFillChar`, returns the class's fill character. Function number two, `CPPGetFillSize`, returns the buffer's size.

Each function is an external, C-style, function, *not* a C++ class member. Each function receives a reference to a `TBuffer` object, and each simply returns the values of class member functions. In this case, those functions are encoded inline, and therefore, despite appearances, there's very little additional overhead. The key advantage is that the assembly language module

can call these two interface functions to obtain data from a class object. Calling class member functions such as `GetFillChar` and `GetFillSize` directly would be very much more difficult (and implementation dependent). Calling the two extra interface functions `CPPGetFillChar` and `CPPGetFillSize` makes it possible to use standard C interfacing between the class and the assembly language module.

Accessing Class Objects from Assembly Language

Listing 13.12, `ASMFILL.ASM`, implements the assembly language function, `_ASMFillBuffer`, called by the `TBuffer` class. The listing also demonstrates how to pass and receive reference arguments to class objects. (The identical techniques work for object pointers as well because C++ references are physically, if not syntactically, identical to pointers.)

Listing 13.12. `ASMFILL.ASM`.

```

1: %TITLE "External function for a C++ class object -- by Tom Swan"
2:
3:         IDEAL
4:         MODEL    small
5:
6: ;----- Code segment
7:
8:         CODESEG
9:
10:        EXTRN  _CPPGetFillChar:PROC ; Function in C++ module
11:        EXTRN  _CPPGetFillSize:PROC ; Function in C++ module
12:        PUBLIC _ASMFillBuffer      ; Function in asm module
13:
14: ;-----
15: ; void ASMFillBuffer(TBuffer far &bo, char far *buffer);
16: ;-----
17: PROC    _ASMFillBuffer    NEAR
18:
19:        ARG bo_offset:DWORD, buffer_offset:DWORD
20:
21:        push  bp           ; Save caller's bp
22:        mov   bp, sp       ; Set up for addressing arguments
23:        push  di           ; Save di if used for register vars
24:
25:        les   di, [bo_offset] ; Get bo object address into es:di
26:        push  es           ; Push bo object address segment
27:        push  di           ; Push bo object address offset
28:        call  _CPPGetFillChar ; Call C++ function, pass object arg
29:        add   sp, 4        ; Adjust stack pointer to delete arg
30:        push  ax           ; Save char result in al on stack
31:
32:        les   di, [bo_offset] ; Get bo object address into es:di
33:        push  es           ; Push bo object address segment
34:        push  di           ; Push bo object address offset
35:        call  _CPPGetFillSize ; Call C++ function, pass object arg
36:        add   sp, 4        ; Adjust stack pointer to delete arg

```

```

37:      mov    cx, ax          ; Copy int result in ax to cx
38:      les   di, [buffer_offset] ; Get buffer address into es:di
39:      pop   ax              ; Retrieve fill character from stack
40:
41: ; al = fill character
42: ; cx = buffer size
43: ; es:di = buffer address
44:
45:      jcxz  @@99            ; Do nothing if count is zero
46:      cld                    ; Set fill direction to forward
47:      rep   stosb           ; Fill buffer: al -> es:di on cx
48: @@99:
49:      pop   di              ; Restore di
50:      pop   bp              ; Restore caller's bp
51:      ret                    ; Return to caller
52: ENDP   _ASMFillBuffer
53:
54:      END                    ; End of module

```

As I did for the C++ module, I'll explain most lines in the assembly language module. This should give you the information you need to handle all interfacing problems between your own C++ OOP code and assembly language.

The module's code segment declares two external functions, `_CPPGetFillChar` and `_CPPGetFillSize`. These are the functions defined in the C++ module that interface with a `TBuffer` object. The key concept here is that the assembly language module does not call class member functions directly. Instead, the assembly language calls interface functions that perform that chore.

In addition, line 12 makes the assembly language function `_ASMFillBuffer` public so that the C++ module can call it.

Lines 17-52 implement the function, which is passed two arguments on the stack. An `ARG` directive at line 19 prepares two `DWORD` offsets for accessing these arguments. They are `DWORDS` because 32-bit pointers are used. (The arguments are declared *far* in the C++ module.)

As I explained, when using `ARG`, you must save and initialize register `bp` for addressing arguments passed on the stack. Lines 21-22 handle this task. I also push register `di` because the function uses this register.

NOTE

Turbo C, Turbo C++, and Borland C++ use `si` and `di` for register variables. Unless you disable register variables, you should save and restore `si` and `di` in functions that use these registers.

Line 25 shows how to obtain the address of a class object passed to an assembly language function. The `les` instruction loads the address referenced on the stack relative to `bp` into the `es:di` registers. After this step, in other words, `es:di` address the `TBuffer` object passed by reference to `_ASMFillBuffer`.

We need that object address in order to call its `GetFillChar` member function. But, as I've said, calling member functions directly is too difficult to do correctly and, besides, would make the program highly implementation dependent. To avoid these nasty problems, simply call an interface function such as `_CPPGetFillChar`, which calls the actual class member function. The interface function requires the address of a `TBuffer` object, which the assembly language function pushes onto the stack at lines 26-27.

Following the function call, as with all calls to C and C++ functions, the program deletes the pushed argument by adding an appropriate value to the stack pointer (see line 29).

The `_CPPGetFillChar` interface function returns the fill character in register `ax`. We need this value a bit later, so line 30 pushes it onto the stack for safe keeping.

Next, the program calls the second interface function `_CPPGetFillSize`. First, `les` at line 32 loads the buffer address, which is pushed onto the stack before calling the interface function at line 35. The stack is adjusted after this function call (line 36), and the returned fill size integer is moved into register `cx` (line 37).

Line 38 again uses `les` to load `es:di` with the address of the buffer, passed to the assembly language function as its second argument. Finally, line 39 pops the saved character back into `ax`.

In programs that use multiple parameters, I find it helpful to insert a comment that describes the states of various registers at strategic locations. The comments at lines 41-43 indicate the values stored in `al`, `cx`, and `es:di` at this point in the program's execution. It's instructive to review the preceding code at this point to verify that each register is prepared properly.

With the dirty work out of the way, the assembly language function can proceed to fill the buffer with the designated character. This is the easiest part of the process. Line 45 skips the next two instructions if the buffer length is zero. Line 46 ensures that the fill direction is forward (to greater addresses). Line 47 performs the fill in a flash, using the super fast repeated `stosb` (store string byte) instruction.

Finally, lines 49-51 restore the saved values of the `di` and `bp` registers before returning to the function's caller.

Summary

The main reasons for adding assembly language to C and C++ programs are to add speed to your code and to provide low-level access to the hardware. Borland's C and C++ compilers offer two methods for injecting assembly language into programs: inline `asm` statements and external functions. Inline statements are easy to use but aren't as versatile as external functions.

Because most programs spend 90% of the time running about 10% of the instructions, finding and optimizing a program's critical 10% often produces remarkable speed increases. Rewriting the other 90% may be a waste of time. Don't rewrite C or C++ statements that already run as fast as necessary.

Registers `bp`, `cs`, `ds`, `sp`, and `ss` must be restored before an assembly language module ends. Registers `ax`, `bx`, `cx`, `dx`, `di`, `si`, and `es` may be used freely. Because compiled C and C++ programs use `di` and `si` for register variables, it's a good idea to preserve these two registers.

Inserting inline `asm` statements causes early versions of Turbo C to generate an assembly language text version of the entire program. This file can then be assembled and linked to create the finished program. You can save time by using the `-B` option to compile programs to assembly language from the start, or you can insert to compile programs to assembly language from the start, or you can insert an equivalent `#pragma inline` statement. Another option `-s` lets you examine the assembly language text file, which is normally removed.

Inline `asm` statements inside functions go in the program's code segment. Inline `asm` statements outside functions go in the program's data segment. You can share code and data with C and C++, and you can access C and C++ structures in assembly language statements.

Writing external assembly language functions takes more work than injecting `asm` statements directly into a C or C++ program, but the results are often worth the effort. External modules save compilation time by letting you develop programs in pieces—and there's no need to compile the program to assembly language text. You can also use Ideal mode in assembly languages modules. Best of all, simplified memory models make writing external functions easier than if you had to declare segments "the hard way," which you still can do if you want. Assembling, compiling and linking multimodule programs is tricky, but using the compiler as a "front end" to Turbo Linker can save time and hassle.

Calling assembly language functions from C or C++ is identical to calling other functions. Going the other way—calling functions from assembly language—requires you to push function parameters onto the stack and then, after the function returns, to remove those parameters. You can also declare local variables in functions, although programs may run faster if you can use a register to hold temporary values.

Name mangling in C++ complicates the task of mixing C++ and assembly language. Disable name mangling with `extern "C"` declarations for assembly language functions called by C++, and also for C++ functions called by assembly language modules.

Interfacing C++ classes and assembly language directly is too difficult, and is far too implementation dependent. Instead of attempting to call class member functions directly from assembly language, a more practical method demonstrated in this chapter uses interface functions that call the actual class members. Passing object references to these functions makes it relatively simple to mix assembly language and C++. Best of all, the end results are portable and independent of implementation details.

Exercises

- 13.1. What are the two ways of adding assembly language to C programs? How does compilation differ between the two methods?
- 13.2. When is it necessary to save and restore registers `si` and `di` in an assembly language function? When is it not necessary to do this?
- 13.3. Write an inline assembly language function to display the values of the 8086 flags. The only C statement you may use is a call to `printf` to display the results—the rest of the instructions should be `asm` statements. Hint: See Figure 4.2 for flag bit positions.
- 13.4. Suppose you have C structure names `Things` and a variable of this structure named `MyThings`. What inline `asm` statement can you use to load the *address* of a structure field named `OneThing`?
- 13.5. What command-line option can you use to compile a program to assembly language text? What is the danger of doing this?
- 13.6. Suppose you have two external functions named `FUNC1.ASM` and `FUNC2.ASM`. What commands are required to assemble, compile, and link the external modules to a main C program named `MAIN.C`, creating a finished program named `MAIN.EXE`? Assume the program uses the small memory model.
- 13.7. What `ARG` directive can you use to address the parameters of the following function prototype?

```
extern void copystring( unsigned char far * source,
                      unsigned char far * destination,
                      int sourcelen );
```
- 13.8. What C statements are needed to call the external function as defined in question number #13.7?

- 13.9. Write an external module to finish the `copystring` function listed in questions #13.7 and #13.8. The module should copy `sourceLen` characters from a source string to the destination string.
- 13.10. Given the external function in question #13.9, what assembly language statements do you need to call the function to pass the address and length of two strings `string1` and `string2`, declared in an external data segment?

Projects

- 13.1. Compile various C or C++ programs (perhaps from a public domain library) with the `-s` option, creating `.ASM` files that you can examine. Hunt for statements where inline `asm` code would improve running times. Recompile, run-time trials, and keep track of the results of your optimizations.
- 13.2. Convert the procedures in `ASYNCH.ASM` module from Chapter 10 (or another module if you prefer) to external C or C++ functions.
- 13.3. The standard C `printf` function is certainly versatile—able to write all sorts of string, character, and numeric data to the standard output. But programming such versatility takes time. Write a set of simplified output functions for writing strings and integers.
- 13.4. Develop a fast direct-video library of external C functions for displaying text on the PC's memory-mapped video screen.
- 13.5. Write a C or C++ program to convert all the text in a file to lowercase, perhaps also capitalizing sentences. After debugging your program, selectively convert sections to assembly language to improve running times.
- 13.6. Use Turbo Debugger to trace function calls to various routines in Borland C++ or Turbo C's runtime library. Document as much of the code as you can. (This is a useful exercise for learning how standard functions are implemented in assembly language.)

14

CHAPTER

Programming with Objects

- Object-Oriented Programming with TASM, 584
- Why Use OOP?, 584
- Fundamentals of TASM Objects, 589
- Polymorphism, 627
- Other OOP Tips and Tidbits, 645
- Summary, 651
- Exercises, 651
- Projects, 652

Object-Oriented Programming with TASM

Object-oriented programming, or *OOP*, has become the mainstay of high-level languages such as C++ and Borland Pascal. Until recently, if you wanted to use OOP, you had to write code with one of those languages or with a less well-known application-development system such as Smalltalk or Actor.

Beginning with TASM 3.0, however, you can now write object-oriented programs in assembly language. Exactly *why* you might want to do that is one of the most difficult aspects of learning to use OOP, so before digging into TASM's object-oriented features, read the following sections for an overview of OOP and its value to programmers.

Why Use OOP?

In a nutshell, OOP makes it possible to write computer programs largely by constructing *objects*. An object is simply a structure that relates data and code (see Figure 14.1), collectively known as the object's *members*. The object *encapsulates* its members in one handy package.

Figure 14.1.
An object is a structure that encapsulates data and code.

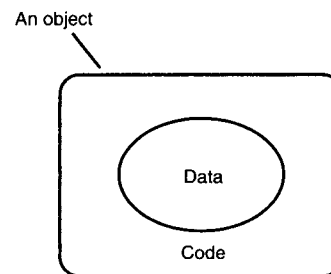

Here are a couple of key points about the object in Figure 14.1.

- The code in an object usually performs some operation on the object's data. This is not a requirement but is usually the case. An object's code consists of subroutines, called *methods*, that you write the same way as conventional subroutines.
- The data inside an object is *hidden*. Only the object's code may directly access the object's data. As usual in assembly language, you can easily break this rule, but you deviate from OOP's regulations at your own peril. An object's data can be any variables (bytes, words, arrays, structures, pointers, and so on, even other objects) that you might define in a conventionally-written program.
- To use an object, you must create storage for it. The storage is called an *instance*—the object-oriented equivalent of a variable of a data type such as a byte or a word. You may define as many instances of an object as you need.

- You can construct new objects based on existing ones—a technique called *inheritance*. Using inheritance, you can write entire programs simply by enhancing a library of existing objects.

Programming with objects offers several advantages over conventional techniques—but there are also a few drawbacks that you need to consider. The following sections describe many of OOP's features, advantages, and disadvantages.

Advantages of OOP

To understand the value of objects, consider how most programmers write conventional code. First, they define the program's data by reserving storage for bytes, words, and other structures. Then, they write subroutines to operate on that data. Or, they write statements that pass data to subroutines, or that pass addresses in registers or that push values onto the stack for a subroutine to use.

There is nothing wrong with this conceptual model for writing computer programs. But when programs grow beyond the moderately complex stage, one part of a program might inadvertently change data that another part requires, causing buggy twists and turns in the program's execution that can be difficult to unravel.

Even top-notch programmers are surprised to discover how easy it is to create such tangles. For example, you might define a global count variable, which you use in a loop that cycles a specified number of times. If that loop calls another subroutine, which calls other subroutines—a common situation—the danger exists that a statement somewhere deep inside the program might also use count for its own purposes. This critical but easily missed error results in a buggy loop that modifies its own controlling parameter and causes the program to fail.

Object-oriented programming can help prevent these kinds of conflicts. Because objects *encapsulate* code and data, the use of data is restricted to a defined set of subroutines. Encapsulation offers programmers two distinct advantages:

- When a bug arises due to the misuse of data, *you are almost certain to find the problem among the offending object's code*. Especially in large programs, being able to restrict debugging to relatively small sections is a tremendous advantage in maintaining applications and identifying trouble spots.
- It's easier to add new code to object-oriented programs. Because the use of data is restricted to an object's subroutines, you can safely use data in new programming without introducing conflicts in other modules. *You always know the limits of data's use*. This aspect of OOP is of key importance to developers, especially in applications written by programming teams.

Disadvantages of OOP

Despite its rosy prospects, OOP has a few drawbacks. It is initially more difficult to design an object-oriented application. If you are the kind of programmer who, when freshly inspired by a great new idea can't wait to start typing instructions, OOP might be the wrong programming model for you. With OOP, careful planning is essential to achieving reliable results.

OOP tends to be of more value in large programs than in small ones. The sample listings in this chapter, for example, might seem to use overly complex methods for relatively simple operations. If you write medium to small programs, OOP might *increase* your code's complexity. (Even small programs, however, can often use libraries of existing objects advantageously.)

OOP and Turbo Assembler

Turbo Assembler's OOP features resemble those in Pascal and C++, although there are some important differences that I'll describe in this chapter. In assembly language, for instance, it is your responsibility to construct various tables, pointers, and to perform operations such as loading registers that are automatic in other languages.

It is also easier to get into trouble with OOP in Turbo Assembler than it is in other languages, which have built-in safeguards that can prevent mistakes. For example, C++ and Borland Pascal compilers can verify that statements use the correct types of objects. In assembly language, all bets are off and it's relatively simple to break OOP's rules (as it is to break conventional programming's rules).

One other disadvantage of OOP in Turbo Assembler is that object instances (that is, variables of a certain object data type) are incompatible with C++ classes and Pascal objects. If you intend to combine assembly and high-level OOP code, it is probably best to use the high-level language to construct your object-oriented modules. See Chapter 13, "Mixing Assembly Language with C and C++" for suggestions about mixing assembly language to high-level C++ OOP.

NOTE

Turbo Debugger's object-oriented commands (ViewHierarchy, for example) do not recognize TASM objects. You may inspect object instances in Turbo Debugger, but they are shown as structures, not objects.

Despite these drawbacks of using OOP in Turbo Assembler, there are many good reasons for selecting this programming model to write assembly language applications. As I suggested,

OOP is tailor-made for large applications, especially those written by programming teams. Also, debugging, maintenance, and future revisions are potentially simpler due to OOP's design.

Another good reason to use OOP is to convert an existing high-level C++ or Pascal object-oriented program into pure assembly language. If you need to convert high level OOP code to assembly language, TASM's OOP features will greatly simplify the conversion.

OOP on Its Own Terms

Like all technologies, OOP comes with its own terms, many of which you will encounter in this chapter. Scan these terms now to become familiar with them, but don't be concerned if some of the concepts are unclear.

NOTE

The following glossary also explains differences and similarities between C++, Borland Pascal, and Turbo Assembler's OOP terminologies. Turbo Assembler's terms more closely resemble those used in Borland Pascal than in C++.

Base object—An object that is used to derive another object. The derived object inherits the properties of the base object. More than one derived object may inherit the properties of the same base object. For example, a graphics program might declare a general-purpose object `TGraphics`, and then use that object as a base to derive special-purpose objects such as `TCircle` and `TRectangle`. The base object provides data and code that are common to all related objects. The derived objects add data and code that are specific to their needs. Any object may be a base object. See also *Derived object*.

Class—The C++ term for *Object* as used in Turbo Assembler and Borland Pascal. See *Object*.

Constructor—A special method that initializes an object instance. Turbo Assembler does not support the concept of a constructor, although as I show in this chapter, you can program its equivalent. (In C++, constructors can be called automatically. In assembly language, it is your responsibility to call an object's constructor.)

Derived object—An object that inherits the properties (data and code) of another base object. A derived object may be used as a base object from which another object may be derived (see *Base object*). The collection of base and derived objects in an object-oriented program creates a hierarchy of related objects. Typical OOP code consists of many such object hierarchies. In Turbo Assembler, a derived object may inherit the properties of only one base object (see also *Single* and *Multiple inheritance*.)

Destructor—A special method that is used to destroy an object instance. Turbo Assembler does not support the concept of a destructor.

Encapsulation—The process of relating data and code in an object. Although not required to do so, an object's code (that is, its assembly language subroutines) usually performs some operation on or with the object's encapsulated data. Encapsulation restricts the use of data to a defined set of subroutines, which can simplify debugging, maintenance, and revisions.

Inheritance—The contents of an object that is derived from another object. The derived object *inherits* the base object's data and code. By using inheritance, you can enhance existing objects quickly and easily. See also *Base object*, *Derived object*, *Single inheritance*, and *Multiple inheritance*.

Instance—Storage for an object. Also called an *Object instance*. An instance of an object is similar to a variable of a data type such as a byte or a word. In Turbo Assembler, you define instances using the same syntax as for structures. (An instance is equivalent to a C++ *class object*.)

Member—Any component of an object. A method, for example, is a member of an object. A variable in an object is a data member.

Method—Another term for an object's subroutines. See also *Static method* and *Virtual method*. (A method is equivalent to a C++ *member function*.)

Multiple inheritance—A feature of some OOP languages that permits deriving new objects, using inheritance, from more than one base object. TASM does not support multiple inheritance (see *Single inheritance*).

Object—A special structure that relates data and code. It's important to understand that an object is merely a *source-code description* of related data and code. Objects exist solely in the program text; they do not exist at runtime. To use an object in a program, you must create an *instance* of it similar to the way you create variables of other data types such as bytes and words. (An object in Turbo Assembler is equivalent to a C++ *class*.)

Object instance—Same as Instance.

Polymorphism—The process by which an object instance can determine an action to be performed on or for that object. The action is implemented as a virtual method. A pointer (the `ds:si` registers, for example) might address an instance of a graphics object derived from a common base. Calling that instance's virtual Draw method draws a circle if the pointer addresses a Circle instance, or a rectangle if the pointer addresses a Rectangle instance. The correct function is selected at runtime without the program explicitly stating the object's type in a call instruction. With polymorphism, you modify the actions of existing code by writing new objects and virtual methods. See also *Virtual method*.

Single inheritance—The technique of building a derived object from a single base object. All OOP languages, including Turbo Assembler, support single inheritance. See also *Multiple inheritance*.

Static method—An object's subroutine. Calls to static methods are identical to calls to non-object-oriented subroutines. The addresses of static methods are bound into `call` instructions at link time.

Virtual method—An object's subroutine. Calls to virtual methods are made indirectly to addresses stored in an object's virtual method table. The addresses of virtual methods are bound into the `call` instruction at run time. See also *Polymorphism*.

Virtual method table (VMT)—A table of virtual method addresses. Every object that has one or more virtual methods must have an associated virtual method table. It is your responsibility to create this table and to insert and initialize a pointer to the VMT in every object instance.

Fundamentals of TASM Objects

To learn how to use OOP in Turbo Assembler programs, you need to master three fundamental techniques. These are:

- Encapsulation
- Inheritance
- Virtual methods

You also need to learn how to combine those techniques using *polymorphism* to create objects that can determine their own actions. The rest of this chapter is devoted to these topics. I'll first explain the techniques of encapsulation, inheritance, and virtual methods in general terms, and then show how to implement those techniques using Turbo Assembler objects. Finally in this chapter, I'll explain how to create and use a list object that demonstrates the wonderful world of programming with polymorphism.

NOTE

Borland's user guide suggests using Ideal mode for object-oriented programs, but for unexplained reasons, all examples in the guide and on disk use MASM mode. Worse, many of the printed examples contain mistakes and do not work correctly. Needless to say, these facts have prevented many assembly language programmers from using TASM's object-oriented features. All example programming in this chapter uses Ideal mode. Because there is no official documentation on Ideal mode and OOP, I derived most of the syntax and example programs in this chapter by experimentation.

Encapsulation

Objects are similar to structures created with the `STRUC` directive. In case you need a refresher course on using assembly language structures, following is a quick review.

A `STRUC` associates multiple variables under a single name. For example, to create a `STRUC` named `Point`, you can use a declaration such as this:

```
STRUC Point
  x dw ?
  y dw ?
ENDS Point
```

The declaration creates a structure named `Point` that contains two word variables, `x` and `y`. The structure is merely a *description* of a data type—it does not occupy any space at runtime. To use the structure, you must define a variable of its type. For example, you might insert these instructions in a data segment:

```
DATASEG
p1 Point <>
p2 Point <45, 68>
```

The first line starts the data segment. The second line defines a variable `p1` of the `Point` structure—in other words, `p1` is a memory space that consists of two word variables named `p1.x` and `p1.y`. The third line also defines a variable `p2` of the `Point` structure. In addition, the third line initializes its two word variables to 45 and 68, respectively.

You create objects using a special form of the `STRUC` directive. Actually, objects *are* structures—but in addition to containing data, an object also specifies subroutines, called *members*, that usually operate on or with that data. Typically, some of those members assign values to the object's data. Other members might return the data's values. Members can perform additional tasks as well.

Following is a sample object, `TPoint`, that declares four methods: two for changing the object's `x` and `y` variables, and two for returning those values:

```
STRUC TPoint METHOD {
  getx:dword = TPoint_getx
  gety:dword = TPoint_gety
  setx:dword = TPoint_setx
  sety:dword = TPoint_sety
}
  x dw ?
  y dw ?
ENDS TPoint
```

Compare this `STRUC` with the non-object-oriented `Point` structure. The keyword `METHOD` tells the assembler that this structure specifies the names of subroutines to be associated with the object. Subroutine declarations in braces follow the `METHOD` keyword. Each declaration is in the form:

```
getx:dword = TPoint_getx
```

This states that the object has an associated method named `getx`, and that the address of that method is to be stored in a `dword` (32-bit) pointer. (Small memory model programs may use a `word` offset in place of `dword`.) The method pointer (`getx`) is initialized to the address of the actual subroutine (`TPoint_getx`), which you must write somewhere in the program using the `PROC` directive as you do for other subroutines (of course, a complete example would have additional instructions):

```
PROC    TPoint_getx PASCAL
        ret
ENDP    TPoint_getx
```

The naming convention that I use is arbitrary, but works well. I begin object names with `T`, which indicates the object is a data *Type*. The method name (`getx` for example) describes the purpose of the object's subroutine—in this case, to *get* the value of the object's `x` variable. The actual subroutine name in the `PROC` directive combines the object name, an underscore, and the method name (`TPoint_getx`). These conventions help me to recognize the relationships among objects, methods, and subroutines.

The other `TPoint` object methods—`gety`, `setx`, and `sety`—are declared similarly. Each is a `dword` pointer initialized to the address of an actual subroutine implemented elsewhere.

After the object's methods are any associated variables, in this case, two uninitialized words, `x` and `y`. Instances (that is, variables) of the `TPoint` object consist of those two words, just as in a common structure. Use the `TPoint` object as you would any structure. These statements, for example, define two `TPoint` instances:

```
p1 TPoint <>
p2 TPoint <12, 34>
```

It is important to understand that the `TPoint` object's methods are *not* stored in the object itself. The object merely *associates* code and data—it doesn't actually store code and data in the same place. The preceding two instances `p1` and `p2` occupy four bytes each—exactly enough room for each instance's two word variables, `x` and `y`.

NOTE

The preceding paragraph will make better sense if you think of objects as data types similar to those built into assembly language—bytes and words, for example. A byte is a *data type*, which merely describes the nature and size of a kind of information. To use a byte, you must define a variable of that type using the `DB` (define byte) directive. Operations such as addition and subtraction that you can perform on bytes aren't stored inside the byte variables. Those operations are instead written as subroutines or instructions to which you pass byte values. The difference in object-oriented programming is that, rather than pass data to subroutines, you call methods for object instances. In that sense, the instance “knows” how to perform operations on itself.

These facts lead to an important observation: *objects and structures are really one and the same*. They differ, however, in how you use them. You use structures as you do any other variables, but with objects, you call *methods* to operate on instance data. To help you understand how this works, the next two listings flesh out the full TPoint object.

Listing 14.1, TPOINT.INC, shows how to declare and implement a Turbo Assembler object. The file is stored in the OOP\ENCAPSUL directory. (All programs in this chapter are similarly stored in their own directories.) The module is designed to be included into a program with the INCLUDE directive, so don't attempt to assemble it just yet. Later, I'll explain how to do that. Scan TPOINT.INC now, then turn to the line-by-line discussion following the listing.

NOTE

Borland suggests storing object declarations in files ending with the extension .ASO (for assembly language object). I use .INC instead because my text editors are programmed to recognize that filename extension. You can name your object module files using any other extension if you want.

Listing 14.1. oop\encapsul\TPOINT.INC.

```

1: %TITLE "TPoint object -- by Tom Swan"
2:
3: GLOBAL TPoint_getx:PROC
4: GLOBAL TPoint_gety:PROC
5: GLOBAL TPoint_setx:PROC
6: GLOBAL TPoint_sety:PROC
7:
8: STRUC TPoint METHOD {           ; Begin TPoint object declaration
9:   getx:dword = TPoint_getx     ; Return object's x data
10:  gety:dword = TPoint_gety     ; Return object's y data
11:  setx:dword = TPoint_setx     ; Change object's x data
12:  sety:dword = TPoint_sety     ; Change object's y data
13: }                               ; End of method declarations
14: x dw ?                          ; Object's x data
15: y dw ?                          ; Object's y data
16: ENDS TPoint                    ; End TPoint object declaration
17:
18: CODESEG
19:

```

```

20: %NEWPAGE
21: ;-----
22: ; TPoint_getx          TPoint getx method
23: ;-----
24: ; Input:
25: ;     ds:si = instance address
26: ; Output:
27: ;     ax = instance.x data
28: ; Registers:
29: ;     ax
30: ;-----
31: PROC    TPoint_getx PASCAL
32:     mov    ax, [(TPoint PTR si).x] ; Move instance x data into ax
33:     ret                                ; Return to caller
34: ENDP    TPoint_getx
35: %NEWPAGE
36: ;-----
37: ; TPoint_gety          TPoint gety method
38: ;-----
39: ; Input:
40: ;     ds:si = instance address
41: ; Output:
42: ;     ax = instance.y data
43: ; Registers:
44: ;     ax
45: ;-----
46: PROC    TPoint_gety PASCAL
47:     mov    ax, [(TPoint PTR si).y] ; Move instance y data into ax
48:     ret                                ; Return to caller
49: ENDP    TPoint_gety
50: %NEWPAGE
51: ;-----
52: ; TPoint_setx          TPoint setx method
53: ;-----
54: ; Input:
55: ;     ds:si = instance address
56: ;     x (word) parameter
57: ; Output:
58: ;     none
59: ; Registers:
60: ;     ax
61: ;-----
62: PROC    TPoint_setx PASCAL
63:     ARG    @@x:word                ; Create stack offset to param x
64:     USES   ax                      ; Preserve ax (optional)
65:     mov    ax, [@@x]                ; Move x param into ax
66:     mov    [(TPoint PTR si).x], ax ; Move x param into instance.x
67:     ret                                ; Return to caller
68: ENDP    TPoint_setx
69: %NEWPAGE
70: ;-----
71: ; TPoint_sety          TPoint sety method
72: ;-----

```

continues

Listing 14.1. continued

```

73: ; Input:
74: ;     ds:si = instance address
75: ;     y (word) parameter
76: ; Output:
77: ;     none
78: ; Registers:
79: ;     ax
80: ;-----
81: PROC   TPoint_sety PASCAL
82:     ARG   @y:word           ; Create stack offset to param y
83:     USES  ax                ; Preserve ax (optional)
84:     mov   ax, [@y]          ; Move y param into ax
85:     mov   [(TPoint PTR si).y], ax ; Move y param into instance.y
86:     ret                               ; Return to caller
87: ENDP   TPoint_sety

```

Lines 8–16 declare the TPoint object, which has four methods and two variables. The module also has four GLOBAL statements at lines 3–6, which publish method subroutine names such as TPoint_getx so other modules can call them.

NOTE

When used to *export* a symbol as done here for TPoint's methods, GLOBAL is interpreted as a PUBLIC directive. When used to *import* a symbol, as might be done by another module that needs to use the TPoint object, GLOBAL is interpreted as an EXTRN directive. You could use PUBLIC and EXTRN directives with object methods, but the dual-purpose GLOBAL directive is more convenient.

After these declarations, at line 18 the module begins or continues the program's code segment. Following that are the object's method implementations—in other words, its subroutines, which are stored along with the program's other code. The TPoint_getx method, for example, is implemented as a subroutine at lines 31–34.

This subroutine has only two instructions. Line 32 moves the value of an object instance's x variable into the ax register. Line 33 returns to the method's caller. As this part of the listing demonstrates, you write object methods the same way you write conventional subroutines.

There is, however, one major difference between TPoint_getx and conventional code. Like all methods, TPoint_getx must be called in reference to an instance of the TPoint object. By convention, registers ds:si address this instance.

Line 32, for example, obtains the value of the instance's x variable by addressing the object instance with ds:si. Carefully examine the syntax in this line—it differs from the syntax in

Borland's User Guide, which doesn't explain how to use Ideal mode with TASM's OOP features. You must use parentheses around the subexpression `(TPoint PTR si)` so that the assembler treats this as a unit. You also must tell the assembler the type of object addressed by `ds:si` (TPoint in this example). Finally, you must include a `PTR` directive to indicate an indirect reference to memory.

NOTE

Calling `TPoint_getx` requires a special form of the `call` instruction provided by the directive `CALL...METHOD` that is unique to Turbo Assembler. Following the next listing, I'll explain how to use this directive.

The next method in `TPOINT.INC`, `TPoint_gety`, is identical to `TPoint_getx` but returns the value of an object instance's `y` variable (see lines 46–49).

Two more methods, `TPoint_setx` and `TPoint_sety`, complete the implementation of TPoint's methods. The method at lines 62–68 demonstrates how to receive arguments passed by instructions that call the method. In this case, `TPoint_setx` requires its caller to pass a 16-bit word of data to store in an object instance's `x` variable (line 63).

You may pass information to methods using any technique you wish in a register, for example, as a global variable, or on the stack. The demonstration method uses a stack argument, declared as:

```
ARG @@x:word
```

The directive tells the assembler to calculate the offset into the stack of a 16-bit word parameter, and to give that offset the name `@@x`. You may use any name you want—because of its local-symbol preface (`@@`), the symbol is limited for use in the current `PROC`. This means that another `PROC` may define an argument named `@@x` without conflicting with this one.

NOTE

When using `ARG`, it is important to select a consistent language in addition to the memory model. All methods in the TPoint object (and others in this chapter) use the PASCAL model, which makes the called subroutines responsible for cleaning up their own stack frames.

Following the `ARG` directive, `TPoint_setx` also tells the assembler that it uses the `ax` register (line 64). The `USES` directive automatically inserts `push` and `pop` instructions to save and restore registers. You don't have to use `USES`, but it's convenient for ensuring that a subroutine saves and restores critical registers. Separate multiple registers with commas as in:

```
USES ax, cx, si, es
```

By virtue of the `ARG` directive, it's a simple matter to refer to arguments passed on the stack. For example, to load the value of the `x` argument into `ax`, the subroutine executes this instruction at line 65:

```
mov ax, [@@x]
```

Line 66 then stores that value in the object instance's `x` variable. The `TPoint_sety` method at lines 81–87 resembles `TPoint_setx`, but inserts a 16-bit argument into an object instance's `y` variable.

The next step is to use the `TPoint` object by including its module in a host program. Using an object involves three key techniques:

- Defining object instances
- Addressing object instances
- Calling object methods

Listing 14.2, `ENCAPSUL.ASM`, demonstrates these techniques. You may now assemble the program, which includes the `TPOINT.INC` module. Change to the `OOP\ENCAPSUL` directory, and type `make` to assemble and link the program. Or, you can enter the following two instructions. Either way, be sure to add debugging information to the `ENCAPSUL.EXE` program, which, like many of this book's example programs, doesn't produce any on-screen output. You need to use Turbo Debugger, as described after the listing, to investigate how the program works.

```
tasm /zi encapsul
tlink /v encapsul
```

Listing 14.2. `oop\encapsul\ENCAPSUL.ASM`.

```
1: %TITLE "TPoint object demonstration -- by Tom Swan"
2:
3:     IDEAL                ; Select Ideal mode syntax
4:
5:     JUMPS                ; Enable auto-conditional jumps
6:
7:     LOCALS @@           ; Enable block-scoped labels
8:
9:     MODEL large, PASCAL ; Select a memory model and language
10:
11:    STACK 1000h          ; Allocate program stack
12:
13:    INCLUDE "tpoint.inc" ; Include TPoint object module
14:
15:    DATASEG              ; Start of data segment
16:
17:    exCode DB 0          ; Program exit code
18:
```

```

19: ;----- Define TPoint instances
20:
21: p1    TPoint <>           ; Default TPoint instance
22: p2    TPoint <01h, 02h>  ; Initialized TPoint instance
23:
24:      CODESEG              ; Start of code segment
25:
26: Start:
27:     mov    ax, @data       ; Initialize DS to address
28:     mov    ds, ax         ; of data segment
29:
30: ;----- Call TPoint methods
31:
32:     mov    si, offset p1   ; Address instance with ds:si
33:     CALL   si METHOD TPoint:getx ; Call object method
34:
35:     mov    si, offset p2   ; Address instance with ds:si
36:     CALL   si METHOD TPoint:gety ; Call object method
37:
38: ;----- Pass literal arguments to methods
39:
40:     mov    si, offset p1   ; Address instance with ds:si
41:     CALL   si METHOD TPoint:setx, 03h ; Pass argument to method
42:
43:     mov    si, offset p1   ; Address instance with ds:si
44:     CALL   si METHOD TPoint:sety, 04h ; Pass argument to method
45:
46: ;----- Pass register arguments to methods
47:
48:     mov    si, offset p2   ; Address instance with ds:si
49:     mov    dx, 05h        ; Load argument into dx
50:     CALL   si METHOD TPoint:setx, dx ; Pass dx on stack to method
51:
52:     mov    si, offset p2   ; Address instance with ds:si
53:     mov    cx, 06h        ; Load argument into cx
54:     CALL   si METHOD TPoint:sety, cx ; Pass cx on stack to method
55:
56: Exit:
57:     mov    ah, 04Ch       ; DOS function: Exit program
58:     mov    al, [exCode]   ; Return exit code value
59:     int    21h           ; Call DOS. Terminate program
60:
61:     END    Start         ; End of program / entry point

```

Several directives are required at the beginning of an object-oriented assembly language program. You can experiment with variations on the types and numbers of directives, but I've found these to work best in most cases:

```

IDEAL
JUMPS
LOCALS @@
MODEL large, PASCAL
STACK 1000h

```

You'll find these same directives in other listings in this chapter (see lines 3–11 in Listing 14.2). The first line selects Turbo Assembler's Ideal mode. In addition to its other benefits (discussed elsewhere in this book), Ideal mode makes a structure's symbols local to that structure. In MASM mode, a structure's symbols are global and must be unique throughout the entire program. This is why Ideal mode requires GLOBAL directives, but despite this added complication, local structure symbols simplify programming by eliminating possibly conflicts among different structures.

The JUMPS directive enables automatic conditional jumps, making it possible for the assembler to generate more efficient code. The LOCALS directive declares @@ as the local-symbol prefix. You will use many local symbols in OOP, and the use of a local prefix will prevent conflicts that would probably arise if you declared symbols such as @@x and @@y globally. Also, some OOP directives generate code that requires this local-symbol preface.

The MODEL directive in this example (line 9) selects the large memory model. Because object-oriented programs tend to be large, this is usually the correct model to use. It is possible, however, to write small and huge memory-model OOP code as I'll explain later in this chapter, but the addressing details in small-model code can be tricky. For best results, use the large model until you know your way around.

NOTE

The MTA.LIB library on the book's disk is assembled for the small memory model. If you link an object-oriented large-model program to this library, you must first create large-model versions of all library modules by editing the MODEL directives. For example, to create a large-model version of the STRINGS module, change the MODEL to large in STRINGS.ASM, then reassemble and insert the module in MTA.LIB using the supplied MAKEFILE on disk.

The MODEL directive at line 9 also specifies the PASCAL language. This does not mean the program is written for Pascal. It merely changes the code inserted by the assembler for the PROC and ENDP directives. With the PASCAL language model, you declare and pass arguments on the stack in the same order. For example, if a method requires x and y arguments, you must declare and pass them in that order. In addition, the PASCAL model causes the assembler to delete all arguments from the stack by inserting a special form of the ret instruction that adjusts the stack pointer, sp. Other models (the C model, for example) require the caller to a subroutine to clean up the stack. Generally, this is inconvenient, and because OOP code tends to use lots of arguments passed to methods, PASCAL is the best choice.

Finally, the program defines a stack (line 11). Again, because of the heavy use of stack arguments in OOP code, a larger than normal stack may be required. I used 1000h for all programs in this chapter. You may have to increase this value in large programs with many objects.

To use the `TPoint` object, the sample program includes the `TPOINT.INC` module (line 13). If your program uses more than one object, it should include all modules at this location.

Following those steps, the sample program defines global variables, two of which are object instances. First, a `DATASEG` directive at line 15 begins the program's global data segment. The exit code variable at line 17 is the same as used in most of this book's programs. Lines 21–22 demonstrate two ways to define object instances.

The first line (21) creates an instance of the `TPoint` object named `p1`. Because the angle brackets are empty in this statement, the values of the instances `x` and `y` variables are uninitialized. When viewed in Turbo Debugger, they are set to zero, but in the program's normal use, they might equal any value left over in memory.

The second line (22) defines another object instance, but specifies initial values for the instance's variables. This line creates an instance with `x` set to `01h` and `y` set to `02h`.

The program next demonstrates how to address object instances and how to call object methods. There's one vital rule to memorize: *you must call an object method in reference to an object instance*. In other words, you never call methods out of context; instead, you must specify an object instance on which that method operates.

There are many ways to address object instances—you could pass their addresses as stack variables or you could address them using any combination of registers you choose. Register addressing is probably best, and for consistency, it's a good idea to use the same registers throughout the program to address all object instances. By convention, I use `ds:si`.

Because the sample program's instances are in the data segment, register `ds` is already initialized by the preparatory instructions at lines 27–28. Only one other step is required to address instance `p1`:

```
mov si, offset p1
```

That instruction moves the offset address of instance `p1` into `si`. Now, `ds:si` properly address a `TPoint` object instance, and the program can call any of that object's methods to perform operations on or for that instance. For example, to call the `TPoint_getx` method, which returns the instance's `x` variable, line 33 executes this special form of the `call` instruction:

```
CALL si METHOD TPoint:getx
```

Actually, that's not an assembly language instruction—it's a `CALL...METHOD` directive, which is unique to Turbo Assembler. To distinguish the directive from common subroutine calls, I type it in uppercase, but you can use lowercase if you prefer. The `CALL...METHOD` directive's syntax is somewhat complex:

```
CALL <instance_ptr> METHOD {<object_name>:}  
    <method_name> {USES {segreg:}offsreg}{<extended_call_parameters>}
```

The first element, <instance_ptr>, can be the address of an object or a reference to a register. Because I always address instances with `ds:si`, I insert `si` between the `CALL` and `METHOD` keywords. This satisfies the syntax, but in this case, the register isn't otherwise used. (Later in this chapter, when you investigate virtual methods, this part of the `CALL...METHOD` syntax becomes more important.)

Next, `CALL...METHOD` permits you to specify an object name. *Always* do this. You must refer to an object by name (especially in Ideal mode) in order to also refer to any of that object's members. In this case, you need to insert the name of a method you want to call—the `TPoint:getx` method, for example, as demonstrated in line 33.

NOTE

Specify method names in `CALL...METHOD` statements by typing the object name, a colon, and the method name. Do *not* use the actual subroutine name. For example, as line 33 shows, `TPoint:getx` is the correct way to refer to the `getx` method in the `TPoint` object. The actual subroutine is named `TPoint_getx` in the `TPOINT.INC` module.

As the `CALL...METHOD` syntax indicates, you can specify a `USES` clause in the directive to preserve any registers that the method changes. I prefer to make the methods themselves preserve all registers except those used to pass back information to callers, so I rarely insert `USES` in `CALL...METHOD` statement. If you want to use this option, however, type it like this:

```
CALL si METHOD TPoint:getx USES cx, di
```

Finally in a `CALL...METHOD` instruction, you may list any arguments to be pushed onto the stack. These arguments may be literal values, memory references, or registers. Regardless of form, however, *they are always passed on the stack*. For example, to pass the value `03h` to the `TPoint` object's `setx` method, line 41 uses the instruction:

```
CALL si METHOD TPoint:setx, 03h
```

From that directive, Turbo Assembler generates instructions to push `03h` onto the stack. The `setx` method, as I explained for the `TPOINT.INC` module, uses an `ARG` directive to access that argument.

You can also pass register values to methods. For example, you can move a value into `cx` (or another register) and pass that value with the instruction:

```
mov cx, 04h
CALL si METHOD TPoint:setx, cx
```

Despite appearances, however, the second line does *not* pass a value in `cx` to the `setx` method. It pushes `cx`'s value onto the stack, and the method still must use an `ARG` directive to access that value. (See also lines 48–50 for another example of passing a register value to a method.)

NOTE

Methods may use values passed in registers. If you specify those registers as `CALL...METHOD` arguments, however, they still will be pushed onto the stack, and you *must* declare an `ARG` directive for those arguments. This enables Turbo Assembler to generate a return instruction that deletes the pushed argument bytes by adjusting the stack pointer. If you don't use `ARG`, the stack will overflow, and you should check that all methods specify `ARG` directives for every argument in `CALL...METHOD` directives.

It is highly instructive at this point to run the `ENCAPSUL` demonstration program in Turbo Debugger. Follow these suggestions to investigate how the program works:

1. Change to the `OOP\ENCAPSUL` directory, and type `make` to create the `ENCAPSUL.EXE` code file if you haven't done so already. Enter `td encapsul` to start Turbo Debugger and load the demonstration program.
2. Use the arrow keys to move the flashing cursor up to the `p2` instance, and press `Ctrl+W` to add it to the *Watches* window. Do the same for `p1`. The *Watches* window should now have two `TPoint` entries. Notice that they are shown as "struc" variables, which in reality is what object instances are. Notice also that `p2`'s `x` and `y` variables are initialized to the values in angle brackets in the instance's definition.
3. Press `F7` three times to execute the instructions that initialize `ds` and that address `p1` with `ds:si`. Press `F7` again to execute the first `CALL...METHOD` instruction. The display changes to the `TPOINT.INC` module, and the cursor is poised at the `mov` instruction in the `TPoint_getx` method.
4. Press `Alt+VR` to bring up the *Registers* window, then press `F7` to execute the `mov` instruction. Notice that `ax` changes to the value of the addressed instance's `x` variable. Press `F7` again to execute the method's `ret` instruction, which ends this `CALL...METHOD`.
5. Press `F7` four more times to execute the next `CALL...METHOD`, and observe the use of modified registers, which Turbo Debugger highlights. These steps return the `y` variable value for the `p2` instance.
6. The program is now paused at the instruction that moves the offset of instance `p1` to `si`. Press `F7` to execute that instruction. Registers `ds:si` now address the `p1` instance.
7. Before executing the next `CALL...METHOD`, open the *CPU* window (press `Alt+VC` and hit `F5` to expand the window to full screen). You will find instructions that look something like these:

```
push  ax
push  bp
mov   bp,sp
```

```
mov    word ptr [bp+02],0003
pop    bp
push   cs
call   tpoint_setx
nop
```

You are viewing the actual instructions that Turbo Assembler generates for the `CALL...METHOD` command (the one at line 41 in the listing). The first five instructions “punch a hole” in the stack, creating a space for the argument to be passed to the method. The `push cs` instruction simulates a *far* call, after which, a *near* `call` performs the actual call to the method subroutine. The `nop` is a placeholder, left over from the optimization that TASM performs to convert *far* calls to efficient `push cs` and `near call` instructions. This `nop` wastes a byte, but the end result is faster than the equivalent *far* `call`. (The assembler makes this modification for all *far* subroutine calls, not only for object-oriented `CALL...METHOD` directives.)

Use Turbo Assembler’s F7 key to run the remaining instructions. You may do this while viewing the *Module* or *CPU* windows. In the *Module* window, you execute `CALL...METHOD` and other instructions as individual commands, even though as you have seen, they might actually contain multiple steps. In the *CPU* window, you execute those steps individually. Try running the program both ways to further investigate how it works. Press Alt+X to exit the debugger.

Before continuing with the next section, be sure you understand:

- How to declare an object and use `GLOBAL` directives for its methods (review the first part of Listing 14.1).
- How to implement an object method and address object instances (review the subroutines in the second part of Listing 14.1).
- How to define an object instance (review the data segment in Listing 14.2).
- How to address an object instance and call its methods (review the code segment of Listing 14.2).

Inheritance

By using inheritance, you create new objects from existing ones. The new, or *derived object*, inherits the methods and variables of its ancestor, or *base object*. In other words, the derived object is a *copy* of the base object to which you can add new methods and variables.

Those added methods can be completely new, or they can *replace* methods of the same names in the base object. Additionally, replacement methods in the derived object can call the base object methods they replace. You cannot replace an object’s data members; only its methods. You can, however, add new data members to derived objects.

In this section, you learn how to use inheritance to create derived objects in Turbo Assembler. The following three listings demonstrate:

- how to derive a new object based on an existing object
- how to call a derived object's methods
- how a replacement method can call a base object's method

Listing 14.3 declares the sample program's base object, named `TBase` for simplicity. (You can use any name you like for your own objects.) The object has no practical value, but is a useful template for your own OOP tests. I often create an object like this one to experiment with ideas before implementing them in real code. Don't try to assemble the listing yet—I'll explain how to do that at the appropriate time.

Listing 14.3. oop\inherit\TBASE.INC.

```

1: %TITLE "TBase object -- by Tom Swan"
2:
3: GLOBAL TBase_init:PROC
4: GLOBAL TBase_getData:PROC
5:
6: STRUC TBase METHOD {           ; Declare base object
7:   init:dword = TBase_init     ; TBase object method
8:   getData:dword = TBase_getData ; TBase object method
9: }                             ; End of object methods
10: TBase_data    dw    ?       ; TBase object data
11: ENDS TBase      ; End of base object
12:
13: CODESEG
14:
15: ;-----
16: ; TBase_init      TBase init method
17: ;-----
18: ; Input:
19: ;   ds:si = instance address
20: ;   arg1 = word to store in instance
21: ; Output:
22: ;   arg1 -> instance.TBase_data
23: ; Registers:
24: ;   none
25: ;-----
26: PROC    TBase_init  PASCAL
27:   ARG    @@data:word ; Create offset to argument on stack
28:   USES   ax          ; Preserve ax register (optional)
29:   mov    ax, [@@data] ; Move argument into ax
30:   mov    [(TBase PTR si).TBase_data], ax ; Save ax in instance
31:   ret
32: ENDP    TBase_init
33:

```

continues

Listing 14.3. continued

```

34: ;-----
35: ; TBase_getData    TBase getData method
36: ;-----
37: ; Input:
38: ;     ds:si = instance address
39: ; Output:
40: ;     ax = instance.TBase_data
41: ; Registers:
42: ;     ax
43: ;-----
44: PROC    TBase_getData    PASCAL
45:     mov     ax, [(TBase PTR si).TBase_data] ; ax <- base data
46:     ret
47: ENDP    TBase_getData

```

The TBase object declares a single variable (TBase_data), and two methods (lines 3–4 and 6–11). The first method, TBase_init, initializes an instance of the TBase object—that is, it sets the instance’s variable or variables to specified values. The second method, TBase_getData, returns the instance’s variable or variables.

The module next implements the object’s methods. Lines 26–32 program the TBase_init method, which requires a word argument passed by a CALL...METHOD instruction. The method stores that argument in the TBase_data variable.

The TBase_getData method returns an object instance’s TBase_data variable in register ax.

Listing 14.4, TDERIVED.INC, shows how to derive a new object using TBase. The listing shows the relationship between a base and derived object, and it also introduces a few related techniques. You need to study one additional listing before using the module, so don’t assemble the program yet.

Listing 14.4. oop\inherit\TDERIVED.INC.

```

1: %TITLE "TDerived object -- by Tom Swan"
2:
3: GLOBAL TDerived_init:PROC
4: GLOBAL TDerived_getData:PROC
5:
6: STRUC TDerived TBase METHOD {           ; Declare derived object from base
7:     init:dword = TDerived_init         ; TDerived object method
8:     getData:dword = TDerived_getData   ; TDerived object method
9: }                                       ; End of object methods
10:     TDerived_data dw    ?              ; TDerived object data
11: ENDS TDerived                          ; End of derived object
12:
13: CODESEG
14:

```

```

15: ;-----
16: ; TDerived_init          TDerived init method
17: ;-----
18: ; Input:
19: ;     ds:si = instance address
20: ;     arg1 = word to store in base instance data
21: ;     arg2 = word to store in derived instance data
22: ; Output:
23: ;     arg1 -> instance.TBase_data
24: ;     arg2 -> instance.TDerived_data
25: ; Registers:
26: ;     none
27: ;-----
28: PROC    TDerived_init PASCAL
29:     ARG    @@data1:word, \
30:           @@data2:word
31:     USES   ax
32:     mov    ax, [@@data1]          ; Move arg1 into ax *
33:     CALL   si METHOD TBase:init, ax ; Call base init method *
34:     mov    ax, [@@data2]          ; Move arg2 into ax
35:     mov    [(TDerived PTR si).TDerived_data], ax ; Store in instance
36:     ret
37: ENDP    TDerived_init
38:
39: ; ----- * These mov and call statements can also be written as:
40: ;     CALL   si METHOD TBase:init, [@@data1]
41:
42: ;-----
43: ; TDerived_getData      TDerived getData method
44: ;-----
45: ; Input:
46: ;     ds:si = instance address
47: ; Output:
48: ;     ax = instance.TBase_data
49: ;     dx = instance.TDerived_data
50: ; Registers:
51: ;     ax, dx
52: ;-----
53: PROC    TDerived_getData PASCAL
54:     CALL   si METHOD TBase:getData ; ax <- base data
55:     mov    dx, [(TDerived PTR si).TDerived_data] ; dx <- derived data
56:     ret
57: ENDP    TDerived_getData

```

You declare a derived object as you do any other, but with one difference. After the new object's name, insert the base object's name. For example, line 6 declares the `TDerived` object like this:

```
STRUC TDerived TBase METHOD
```

The declaration causes `TDerived` to begin life as a copy of `TBase`. In other words, `TDerived` inherits the variables and methods from `TBase`. To its inheritance, `TDerived` declares two replacement methods and a new data member.

The data member, `TDerived_data`, is added to the `TBase_data` variable inherited from the base object. In other words, instances of the `TDerived_data` object now have *two* variables—one named `TBase_data` and one named `TDerived_data`.

Figure 14.2.
Base and derived objects.

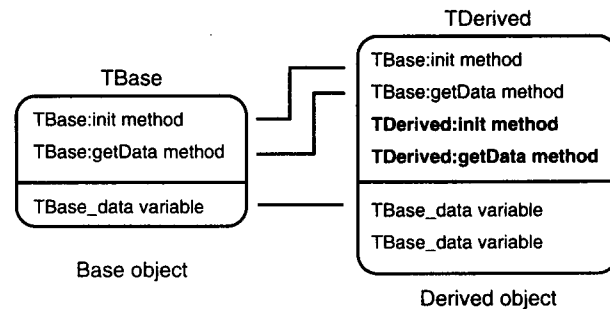

Conceptually, the base and derived objects are structured as Figure 14.2 illustrates. The derived object *inherits* the members from its base object. New members in the derived object are shown in bold face.

The two methods, `init` and `getData`, *replace* the methods inherited from `TBase`. It would be possible for the derived object to declare completely new methods simply by giving them unique names, but the sample object doesn't do this.

As Figure 14.2 illustrates, the new methods don't eliminate the methods they replace—`TBase`'s subroutines are still alive and well in their original module. When a program calls a derived replacement method, however, it calls the replacement code. Often, that code in turn calls the base object's method to perform part of a desired operation in addition to new programming added to the replacement. This is not a requirement, however, and replacement methods sometimes do not call their inherited methods.

For example, lines 28–37 implement the replacement `init` method for the `TDerived` object. The replacement method requires two 16-bit arguments to be stored in an instance's variables—`TDerived` instances now have *two* such variables.

To initialize the inherited `TBase_data` variable, lines 32–33 call the base object's `init` method. Registers `ds:si` already address the instance, so they don't require initialization. The code merely loads `ax` with the first of the subroutine's two arguments, and calls the `TBase` object's `init` method.

Those steps initialize the inherited portion of the object instance. To finish the job, lines 34–35 store the second argument in the `TDerived_data` variable—the new one that `TDerived` adds to its inherited members. Now both of the instance's data variables are initialized.

Method `TDerived_getData` similarly calls its base object's method of the same name (`getData`) to obtain the instance's data (line 54). The next instruction moves the derived object instance's data into `dx`. In this way, the replacement method returns the instance's two variables in register's `ax` and `dx`. Notice especially how the derived object methods call their base object methods to build on existing code. These techniques—enhancing objects through inheritance and replacement methods—are the heart and soul of object-oriented programming.

Listing 14.5, `INHERIT.ASM`, shows how to use the base and derived objects from the preceding two listings. You may now assemble and link the demonstration program, which includes the `TBASE.INC` and `TDERIVED.INC` modules. Change to the `OOP\INHERIT` directory and type `make`. Or, execute these individual commands:

```
tasm /zi inherit
tlink /v inherit
```

NOTE

The demonstration program produces no output. For a better understanding of how the program works, load it into Turbo Debugger with the command `td inherit`. Add the program's variables to the *Watches* window, and use the debugger's F7 key to single step the program's instructions while you read the line-by-line discussion that follows the listing.

Listing 14.5. `oop\inherit\INHERIT.ASM`.

```
1: %TITLE "Inheritance demonstration -- by Tom Swan"
2:
3:     IDEAL
4:
5:     JUMPS
6:
7:     LOCALS @@
8:
9:     MODEL large, PASCAL
10:
11:    STACK 1000H
12:
13:    INCLUDE "tbase.inc"
14:
15:    INCLUDE "tderived.inc"
16:
17:    DATASEG
18:
19: exCode db    0           ; Program exit code
20:
```

continues

Listing 14.5. continued

```

21: b1      TBase   <>           ; Define base object instance
22:
23: d1      TDerived <>         ; Define derived object instance
24:
25:          CODESEG
26:
27: Start:
28:      mov   ax, @data         ; Initialize DS to address
29:      mov   ds, ax           ; of data segment
30:
31:      mov   si, offset b1     ; Address instance b1
32:      CALL  si METHOD TBase:init, \ ; Call base init method
33:          0001h              ; Pass argument to method
34:
35:      mov   si, offset d1     ; Address instance d1
36:      CALL  si METHOD TDerived:init, \ ; Call derived init method
37:          0002h, 0003h       ; Pass arguments to method
38:
39:      mov   si, offset b1     ; Address instance b1
40:      CALL  si METHOD TBase:getData ; Get data into ax
41:
42:      mov   si, offset d1     ; Address instance d1
43:      CALL  si METHOD TDerived:getData ; Get data into ax, dx
44:
45: Exit:
46:      mov   ah, 04Ch          ; DOS function: Exit program
47:      mov   al, [exCode]      ; Return exit code value
48:      int   21h              ; Call DOS. Terminate program
49:
50:      END   Start            ; End of program / entry point

```

As lines 21–23 show, you define derived-object instances no differently from base object instances. A derived object is used the same way as any other object. In fact, as you will see later on, a derived object may itself be a base object for another object. There is no practical limit on the number of objects that you may derive from others.

Lines 31–33 call a base object’s `init` method, to which the `CALL...METHOD` statement passes the value `0001h`. When you trace this code in Turbo Debugger, you see that the method stores the passed argument value in the instance’s `TBase_data` variable.

NOTE

`CALL...METHOD` instructions can be lengthy. For better readability, you may write them on separate lines as shown here. End each preceding line with the “continuation symbol,” a backslash (`\`) (see lines 32 and 36, for example).

Lines 35–37 perform a similar job, but call the derived object's `init` method. This method requires *two* arguments, here the literal values `0002h` and `0003h`. When you trace this instruction in Turbo Debugger, you first arrive in `TDerived`'s `init` method. That method calls the `TBase` object's `init`, which stores the first argument in the instance's `TBase_data` variable. The derived `init` then stores the second argument in `TDerived_data`. In this way, the two methods initialize the object's two variables.

Lines 39–43 call `TBase` and `TDerived` `getData` methods to retrieve the values of the instances' variables. Open the *Registers* window (press `Alt+VR`) to inspect these values as you trace this portion of the code.

Before continuing with the next section, be sure to understand:

- How to derive an object from a base object.
- How to define base and object instances.
- How to call base and derived object methods.
- How to call a base object's method from inside a derived object's replacement method.

Figure 14.3.

Calls to virtual methods are made indirectly by looking up subroutine addresses from a Virtual Method Table (VMT) at runtime.

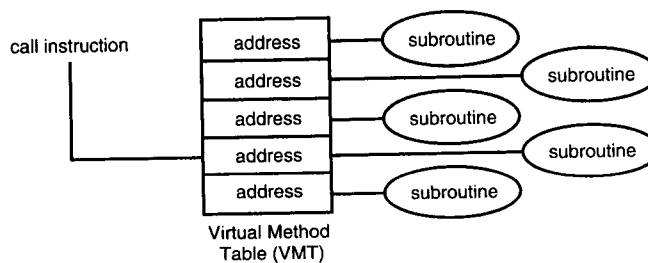

Virtual Methods

Up to now, the object methods you have examined are *static methods*. That is, their addresses are permanently fixed in memory, and consequently, Turbo Assembler can create conventional `call` instructions to the object's subroutines.

Virtual methods differ from static methods in the way you address them. Instead of computing a virtual method's address during assembly, the assembler generates instructions that extract the address at runtime from a *virtual method table* (VMT). Calls to virtual methods are indirect—they are made by reference to entries in a VMT (see Figure 14.3).

Every object that has one or more virtual methods must have a VMT, and every instance of that object must have a VMT pointer that addresses the VMT. `CALL...METHOD` directives automatically extract these addresses, but it is your responsibility to create the VMT and to link it to every object instance by initializing the instance's VMT pointer.

Those basic facts explain what virtual methods are, but do not explain why you might want to use them. Virtual methods are the most powerful tools in object-oriented programming, but their value may not be obvious at first. In brief, virtual methods enable programs to use *polymorphism*, a fancy word for a relatively simple concept, explained by the code in this section.

Figure 14.4.

When a pointer addresses an object instance, calls to the object's virtual methods are computed by looking them up from a virtual method table.

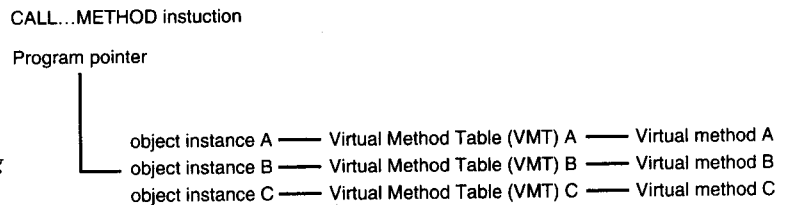

Figure 14.4 illustrates polymorphism conceptually. In the diagram, a `CALL...METHOD` instruction attempts to call a method for an object instance addressed by a program pointer (`ds:si` for example). Because the method is virtual, its address is taken from the VMT that is addressed by a pointer stored in the object instance. Consider what happens if a program instruction changes that pointer to address a different object instance. *The same `CALL...METHOD` instruction will then call a different virtual method.* This is polymorphism—object instances determine at runtime which virtual methods to call. The instances, in other words, *determine their own actions.*

You implement virtual methods the same way you implement static methods. It is the way you call virtual methods that differentiates them from static methods.

To add virtual methods to an object requires one new keyword and three new directives. Follow these steps:

1. Insert one or more virtual methods in the object declaration by prefacing the method declarations with `VIRTUAL`.
2. Insert a VMT pointer in the object's data section by using the `TBLPTR` directive.
3. Define memory space for the VMT by using the `TBLINST` directive.
4. Initialize the VMT pointer for every object instance by using the `TBLINIT` directive.

A few code fragments illustrate those four steps. Here's a sample object, `TBase`, that declares a virtual method and a VMT pointer:

```
STRUC TBase METHOD {
  construct:dword = TBase_construct ; Static method
  VIRTUAL action:dword = TBase_action ; Virtual method (step #1)
}
TBLPTR ; VMT pointer (step #2)
TBase_data dw ? ; Other object data
ENDS TBase
```

The object may have other static methods, and it can have as many virtual methods as needed. Precede each virtual method with the `VIRTUAL` keyword.

NOTE

An object derived from `TBase` inherits the VMT pointer created by `TBLPTR`. The derived object should not define its own VMT pointer. Only the base object in a hierarchy of related objects may use this directive.

After declaring the object, you must define a virtual method table that stores the object's virtual method addresses. Turbo Assembler automatically inserts the proper addresses into this table—all you need to do is create it. But you *must* create a VMT for every object that has one or more virtual methods, a rule that applies equally to base and derived objects. If a base object defines a VMT, an object derived from that base must also define its own VMT. The derived object inherits its base object's VMT *pointer*, not the virtual method table.

To define a VMT, follow the object's declaration with a `TBLINST` directive. This directive creates a VMT for the most recently declared object. You might also want to open a segment for storing VMTs. For example, you might follow the preceding object declaration with these instructions:

```
; step #3
DATASEG
TBLINST
```

You might also follow those instructions with a `CODESEG` directive in order to implement an object's methods, but that's not a requirement. You could, for example, declare multiple objects, define their VMTs, and then implement their methods in another module. Many different arrangements of files, declarations, and modules are possible, though I prefer to insert each object's declarations and methods in a single file to be included in the final program. This approach makes it easy to use objects in different programs, and with a little extra help (as I'll explain in the next section) it also makes it possible to create objects that work with small, large, and huge memory models.

Finally, write a static method that initializes the object's VMT pointer (the one declared by the `TBLPTR` directive). I call this method a *constructor*, though strictly speaking, Turbo Assembler objects don't have the equivalent of C++ or Pascal constructors. Use the `TBLINIT` directive in the constructor to initialize an object instance's VMT pointer. For example, assuming that `ds:si` addresses the object instance, here's one way to write the `TBase` object's constructor:

```
PROC TBase_construct PASCAL
    TBLINIT TBase PTR si ; Initialize VMT pointer
    ret
ENDP TBase_construct
```

You must call the object's constructor for *every* instance of the TBase object. Each such instance has its own VMT pointer, which must be individually initialized. Call the constructor as you do any other static method. For example, in the data segment, first define a TBase instance:

```
b1      TBase  <>
```

Next, in the code segment, address b1 with ds:si and call the TBase object's construct method:

```
mov  si, offset b1
CALL si METHOD TBase:construct
```

NOTE

A constructor cannot be virtual because, in order to call virtual methods, the object instance's VMT pointer must be assigned the address of that object's VMT. The purpose of the constructor is to perform this task, although it may execute other initializations as well.

To call a virtual method, use the same CALL...METHOD directive that calls static methods but with one difference required in Ideal mode. In addition to specifying si as the instance pointer, you must tell the assembler to what base object si points. For example, these instructions address the b1 instance with ds:si and call the object's action virtual method:

```
mov  si, offset b1
CALL TBase PTR si METHOD TBase:action
```

The second line generates instructions that look up the action subroutine's location from the VMT addressed by the TBase instance's VMT pointer. The magic of this instruction is in the fact that si could address a *derived* object instance in which case the derived object's action subroutine will be called. Suppose, for example, that you declare an object TDerived from TBase. You also declare a replacement action method in the new object. You then define the object, address it with ds:si and call the action subroutine:

```
DATASEG
d1 TDerived <>      ; Define derived object instance
CODESEG
...
mov  si, offset d1      ; Address instance with ds:si
CALL TBase PTR si METHOD TBase:action  ; Calls TDerived:action!
```

Even though the CALL...METHOD instruction specifies TBase, the instruction actually calls TDerived's virtual action method. Now, compare the last line in this code fragment with the last line of the preceding example. The instructions are identical—all that's changed is the object that ds:si addresses. You might call this *proof of polymorphism*—the object itself determines which virtual action method to call.

The next several listings demonstrate these concepts. First, however, Listing 14.6, OOMACROS.INC presents a few macros that simplify working with virtual methods. The macros, which I modified and converted to Ideal mode using similar MASM-mode macros supplied on Turbo Assembler 4.0's disks, make it possible to write OOP code for small, large, and huge memory models. On this book's disk, the file is stored in the OOP subdirectory. Don't assemble the text—you have to include it in another program as I'll explain.

Listing 14.6. oop\OOMACROS.INC.

```

1: %TITLE "TASM OOP VMT macros -- by Tom Swan"
2:
3: ;---- Small memory model macros and equates
4:
5: IF (@CodeSize EQ 0)
6:
7:     MACRO    VMTSeg                ;; Store VMTs in code segment
8:     CODESEG
9:     ENDM    VMTSeg
10:
11:    @VMTSeg = @code                ;; Equate VMTSeg with code segment name
12:
13:    MACRO    LoadVMTSeg reg         ;; Prepare VMT segment addressing register
14:        push    cs                 ;; Push code segment onto stack
15:        pop     reg                ;; Pop cs into desired segment register
16:    ENDM
17:
18:    MPtr     EQU    <WORD>        ;; Virtual functions are 16-bit addresses
19:
20: ELSE
21:
22: ;----- Large and huge memory model macros and equates
23:
24:     SEGMENT VMT_Seg PUBLIC        ;; Store VMTs in separate data segment
25:     ENDS    VMT_Seg
26:
27:     MACRO    VMTSeg
28:         SEGMENT    VMT_Seg        ;; Use VMTSeg macro to create VMT segment
29:     ENDM    VMTSeg
30:
31:    @VMTSeg = VMT_Seg              ;; Equate VMTSeg with our data segment
32:
33:    MACRO    LoadVMTSeg reg         ;; Prepare VMT segment addressing register
34:        push    bx                 ;; Save register used by macro
35:        mov     bx, @VMTSeg        ;; Move segment address into bx
36:        mov     reg, bx            ;; Move bx into desired segment register
37:        pop     bx                 ;; Restore saved bx
38:    ENDM    LoadVMTSeg
39:
40:    MPtr     EQU    <DWORD>        ;; Virtual functions are 32-bit addresses
41:
42: ENDIF

```

continues

Listing 14.6. continued

```

43:
44: ;----- Define Virtual Method Table macro (all memory models)
45:
46:     MACRO   Make_VMT
47:         VMTSeg          ;; Start new segment for large & huge models
48:         TBLINST        ;; Create the virtual method table
49:         ENDS           ;; End segment started by VMTSeg macro
50:         CODESEG        ;; Resume code segment
51:     ENDM   Make_VMT

```

The OOMACROS.INC module uses conditional directives to alter its programming depending on the current memory model. Line 5 examines the `CodeSize` symbol. If equal to zero, then the small memory model is being used; otherwise the large or huge models are in effect.

NOTE

I tested the macros in OOMACROS.INC only for the small, large, and huge models if you use a different model, be sure to retest them thoroughly.

The `VMTSeg` macro is a symbol that is equated to `CODESEG` for small model programs (lines 7–9), or to a separate `VMT_Seg` data segment for large and huge models (lines 24–25 and 27–29). You don't need to use the `VMTSeg` macro in a program.

Use the `LoadVMTSeg` macro to initialize a segment register to address the segment that stores VMTs. The macro makes it possible to write memory-model-independent code. For example, before calling one or more virtual methods, in any memory model, insert this instruction to initialize `es` to address the VMT segment:

```
LoadVMTSeg es
```

Under the small memory model, this use of the `LoadVMTSeg` macro (lines 13–16) executes these instructions:

```
push cs
pop es
```

The two instructions set `es` equal to `cs`. By convention, in small-model programs, VMTs are stored in the code segment. (This is not a requirement, but is a result of using the macros in OOMACROS.INC.)

Under the large and huge models, the `LoadVMTSeg` macro generates these instructions:

```

push  bx
mov   bx, @VMTseg
mov   es, bx
pop   bx

```

Thus `es` is set to the address of the separate VMT segment, named `@VMTseg` (lines 31 and 33–38).

`OOMACROS.INC` also defines a symbol, `MPtr`, equated to a `WORD` for small model programs (line 18) or to a `DWORD` for large and huge models (line 40). You may use this macro in object declarations to create memory-model-independent objects. Under the small model, method addresses are 16-bit offsets; under the large and huge models, they are 32-bit segment and offset values. To automate the selection of the correct pointer size, in your object declaration, replace `dword` with `MPtr` as in this fragment:

```

STRUC TBase METHOD {
    construct:MPtr    = TBase_construct
    VIRTUAL action:MPtr = TBase_action
}
    TBLPTR
...
ENDS TBase

```

Also include the `OOMACROS.INC` file before the object declaration. You can now assemble the object for the small, large, and huge memory models.

Finally in `OOMACROS.INC` is a macro that you should use to define VMTs. Insert the macro where you would normally use a `TBLINST` directive, usually after each object declaration:

```

STRUC TBase METHOD    ; Object declaration
...                  ; Object method and data declarations
ENDS TBase           ; End of object declaration
Make_VMT             ; Use this macro instead of TBLINST

```

Under the small memory model, `Make_VMT` switches to the code segment, inserts the VMT (by using `TBLINST`), then reestablishes the code segment with a `CODESEG` directive (which isn't needed in this case, but does no harm).

Under large and huge models, `Make_VMT` switches to the separate VMT segment, inserts the VMT (again using `TBLINST`), and then continues the code segment with `CODESEG`. The result is an object that you can use in small, large, and huge memory-model programs.

The next three listings put the preceding concepts and macros into action. The program is a modified version of the inheritance demonstration in this chapter. This version, however, adds virtual methods to the `TBase` and `TDerived` objects. A demonstration program defines instances of those objects and calls their virtual methods. (The files also make a useful template for starting new object-oriented programs—just copy them to another directory and use your editor's global search and replace command to change the object names.)

NOTE

All files for the next demonstration program are stored in the OOP\VIRTUAL directory. To follow along, change to that directory now.

Listing 14.7, TBASE.INC, declares and implements the TBase object. The module assumes that the OOMACROS.INC file has already been included by a host program. Don't attempt to assemble the program—I'll let you know when you can do that. A line-by-line discussion follows the listing.

Listing 14.7. oop\virtual\TBASE.INC.

```

1: %TITLE "TBase object -- by Tom Swan"
2:
3: GLOBAL TBase_construct:PROC
4: GLOBAL TBase_init:PROC
5: GLOBAL TBase_getData:PROC
6: GLOBAL TBase_action:PROC
7:
8: STRUC TBase METHOD {
9:   construct:mptr      = TBase_construct ; Instance constructor
10:  init:mptr           = TBase_init      ; Instance initializer
11:  getData:mptr        = TBase_getData   ; Static method
12:  VIRTUAL action:mptr = TBase_action    ; Virtual method
13: }
14: TBLPTR              ; Virtual method table pointer
15: TBase_data          dw      ?          ; TBase object data
16: ENDS TBase
17:
18: Make_VMT            ; Define TBase VMT
19:
20: CODESEG
21:
22: ;-----
23: ; TBase_construct   TBase constructor (initialize VMT pointer)
24: ;-----
25: ; Input:
26: ;     ds:si = instance address
27: ; Output:
28: ;     VMT ptr initialized
29: ; Registers:
30: ;     none
31: ;-----
32: PROC   TBase_construct PASCAL
33:     TBLINIT TBase PTR si          ; Initialize instance VMT pointer
34:     ret
35: ENDP   TBase_construct
36:

```

```

37: ;-----
38: ; TBase_init      TBase init method (initialize instance data)
39: ;-----
40: ; Input:
41: ;     ds:si = instance address
42: ;     arg1 = word to store in instance
43: ; Output:
44: ;     arg1 -> instance.TBase_data
45: ; Registers:
46: ;     none
47: ;-----
48: PROC    TBase_init PASCAL
49:     ARG    @@data:word      ; Create offset to argument on stack
50:     USES   ax               ; Preserve ax register (optional)
51:     mov    ax, [@@data]     ; Move argument into ax
52:     mov    [(TBase PTR si).TBase_data], ax ; Save ax in instance
53:     ret
54: ENDP    TBase_init
55:
56: ;-----
57: ; TBase_getData    TBase getData method
58: ;-----
59: ; Input:
60: ;     ds:si = instance address
61: ; Output:
62: ;     ax = instance.TBase_data
63: ; Registers:
64: ;     ax
65: ;-----
66: PROC    TBase_getData PASCAL
67:     mov    ax, [(TBase PTR si).TBase_data] ; ax <- base data
68:     ret
69: ENDP    TBase_getData
70:
71: ;-----
72: ; TBase_action     TBase action VIRTUAL method
73: ;-----
74: ; Input:
75: ;     ds:si = instance address
76: ; Output:
77: ;     ax = 0000 (arbitrary operation for demo)
78: ; Registers:
79: ;     ax
80: ;-----
81: PROC    TBase_action PASCAL
82:     xor    ax, ax           ; ax <- 0000h
83:     ret
84: ENDP    TBase_action

```

I'll describe only what's new in TBase. First, I added a constructor (line 9) method named `construct`. As I mentioned, this method must be static because its job is to initialize an object instance's VMT pointer. Until that happens, the program must not call any virtual methods for those instances. I also added the virtual method `action` (line 12). The TBase object declares a VMT pointer using the `TBLPTR` directive (line 14).

All static and virtual methods must have corresponding GLOBAL directives as shown at lines 3–6. There are no syntactical differences between static and virtual methods in GLOBAL directives.

Following the object declaration, the `Make_VMT` macro defines a VMT for `TBase`. Always use this macro (or the `TBLINST` directive if you are not using the macros in `OOMACROS.INC`) *immediately* after each object declaration.

Line 20 begins or continues the program's code segment. Because the `Make_VMT` macro has already performed this step, line 20 isn't needed, but I included it anyway for consistency with other programs in this chapter. It does no harm to execute multiple `CODESEG` directives.

Lines 22–35 implement the `TBase` constructor. As I explained, this method has one required purpose—to initialize the VMT pointer for every instance of the object. Line 33 performs the step by using the `TBLINIT` directive. The method assumes that `ds:si` addresses the object instance.

NOTE

It's best to separate the processes of constructing and initializing object instances. An object's *constructor* initializes the VMT pointer for an object instance. The object's *initializer* assigns values to the instance's variables. *Do not attempt to combine these steps into one method.* As you will learn from the next listing, a derived object must have its own constructor, but it usually will call its base object's initializer to assign values to inherited variables. Remember also that I use the word *constructor* differently than in C++ and Pascal, and that these are my conventions, not Turbo Assembler's.

Finally in `TBASE.INC` is the implementation of the `TBase` object's virtual method, `TBase_action` (lines 71–84). The actual subroutine is no different from a static method, or from any other subroutine. In this demonstration, `TBase_action` performs no useful operations, but just to give the method something to do, line 82 sets register `ax` to zero by executing an `xor` instruction. Later, when you run this section's demonstration program in Turbo Debugger, this action provides a means to verify that `TBase_action`, and not another subroutine, was called.

Next, Listing 14.8, `TDERIVED.INC` (in the `OOP\VIRTUAL` directory), declares and implements a derived object, `TDerived`, from `TBase`. This module is a revised edition of the similar file and object in this chapter's discussion of inheritance. As for the preceding listing, I'll discuss only what's new and improved in the modified file.

Listing 14.8. oop\virtual\TDERIVED.INC.

```

1: %TITLE "TDerived object -- by Tom Swan"
2:
3: GLOBAL TDerived_construct:PROC
4: GLOBAL TDerived_init:PROC
5: GLOBAL TDerived_getData:PROC
6: GLOBAL TDerived_action:PROC
7:
8: STRUC TDerived TBase METHOD {
9:   construct:mptr      = TDerived_construct ; Instance constructor
10:  init:mptr           = TDerived_init      ; Instance initializer
11:  getData:mptr        = TDerived_getData   ; Replacement static method
12:  VIRTUAL action:mptr = TDerived_action    ; Replacement virtual method
13: }
14:   TDerived_data dw      ?                ; TDerived object data
15: ENDS TDerived
16:
17: Make_VMT             ; Define TDerived VMT
18:
19: CODESEG
20:
21: ;-----
22: ; TDerived_construct   TDerived constructor
23: ;-----
24: ; Input:
25: ;   ds:si = instance address
26: ; Output:
27: ;   VMT ptr initialized
28: ; Registers:
29: ;   none
30: ;-----
31: PROC   TDerived_construct PASCAL
32:   TBLINIT TBase PTR si      ; Initialize instance VMT pointer
33:   ret
34: ENDP   TDerived_construct
35:
36: ;-----
37: ; TDerived_init        TDerived init method
38: ;-----
39: ; Input:
40: ;   ds:si = instance address
41: ;   arg1 = word to store in base instance data
42: ;   arg2 = word to store in derived instance data
43: ; Output:
44: ;   arg1 -> instance.TBase_data
45: ;   arg2 -> instance.TDerived_data
46: ; Registers:
47: ;   none
48: ;-----
49: PROC   TDerived_init PASCAL
50:   ARG   @@data1:word, \      ; Create stack offsets to arguments
51:   @@data2:word
52:   USES  ax                  ; Preserve ax (optional)
53:

```

continues

Listing 14.8. continued

```

54:      CALL    si METHOD TBase:init, ax    ; Call base init method
55:      mov     ax, [@@data2]              ; Move arg2 into ax
56:      mov     [(TDerived PTR si).TDerived_data], ax ; Store in instance
57:      ret
58: ENDP   TDerived_init
59:
60: ; ----- Preceding mov and call statements can also be written as:
61: ;      CALL    si METHOD TBase:init, [@@data1]
62:
63: ; -----
64: ; TDerived_getData      TDerived getData method
65: ; -----
66: ; Input:
67: ;     ds:si = instance address
68: ; Output:
69: ;     ax = instance.TBase_data
70: ;     dx = instance.TDerived_data
71: ; Registers:
72: ;     ax, dx
73: ; -----
74: PROC   TDerived_getData PASCAL
75:      CALL    si METHOD TBase:getData      ; ax <- base data
76:      mov     dx, [(TDerived PTR si).TDerived_data] ; dx <- derived data
77:      ret
78: ENDP   TDerived_getData
79:
80: ; -----
81: ; TDerived_action      TDerived action VIRTUAL method
82: ; -----
83: ; Input:
84: ;     ds:si = instance address
85: ; Output:
86: ;     ax = 0ffffh (arbitrary operation for demo)
87: ; Registers:
88: ;     ax
89: ; -----
90: PROC   TDerived_action PASCAL
91:      mov     ax, 0ffffh                  ; ax <- 0ffffh
92:      ret
93: ENDP   TDerived_action
94:
95: ; ----- Use this to call ancestor function in TDerived_action:
96: ;      call    TBase_action

```

The `TDerived` object inherits the methods and variables from `TBase` (lines 8–15). The new object declares a replacement constructor (line 9), a vital step that you must remember in all derived objects that use virtual methods. The constructor will initialize the derived object's VMT pointer, which is inherited from `TBase`. Notice that `TDerived` does *not* declare this pointer with the `TBLPTR` directive—only one base object in a hierarchy of related objects may use this directive.

TDerived also declares replacement methods for the `init`, `getData`, and `action` static and virtual methods. In addition, the object declares a variable at line 14.

Be sure to understand at this stage that TDerived has *three* data members—a VMT pointer and word inherited from TBase, and a new variable declared at line 14.

VMT pointers are inherited; VMTs are not, and as line 17 shows, you must use the `Make_VMT` macro (or the `TBLINST` directive if you are not using the macros in `OOMACROS.INC`) to create a VMT for the derived object.

After the object declaration and VMT definition, the module implements TDerived's methods. Lines 21–34 implement the object constructor, which as in TBase, uses the `TBLINIT` directive (line 32) to initialize the VMT pointer for TDerived object instances.

NOTE

Do not call the base object's constructor from a derived constructor. Derived object instances must address their own VMTs, not the VMTs of any base objects.

TDerived's static methods, `TDerived_init` and `TDerived_getData`, are unchanged. See this chapter's discussion of inheritance for descriptions of these subroutines. (*Note:* lines 60–61 show an alternate technique for calling a base object method and passing along an argument that was passed to the derived object method. Rather than load the argument into a register and pass it to the base object method as shown at lines 53–54, you can pass it directly in a `CALL...METHOD` instruction as shown at line 61.)

As in TBase, the derived object's virtual action method (lines 80–93) performs no useful operation. Just to give the subroutine something to do, however, the `mov` instruction at line 91 sets `ax` to `0ffffh`. When you run the next listing's test program in Turbo Debugger, this value helps distinguish between calls to the derived and base objects' action methods.

Also as in TBase, notice that `TDerived_action` is simply a plain subroutine, like any other. It is how you call virtual methods that make them special; not their implementations.

Listing 14.9, `VIRTUAL.ASM`, puts the preceding three listings, objects, and macros, into action. You may now assemble and link the demonstration program. To do that, change to the `OO\VIRTUAL` directory and type `make`. Or, enter these commands:

```
tasm /zi virtual
tlink /v virtual
```

NOTE

The VIRTUAL.ASM program produces no output. Run the program under Turbo Debugger to examine how the program works.

Listing 14.9. oop\virtual\VIRTUAL.ASM.

```

1: %TITLE "Virtual function demonstration -- by Tom Swan"
2:
3:     IDEAL
4:
5:     JUMPS
6:
7:     LOCALS @@
8:
9:     MODEL large, PASCAL
10:
11:     STACK 1000H
12:
13:     INCLUDE "..\oomacros.inc"
14:
15:     INCLUDE "tbase.inc"
16:
17:     INCLUDE "tderived.inc"
18:
19:     DATASEG
20:
21: exCode db    0                ; Program exit code
22:
23: ;----- Define objects with no default values
24:
25: b1     TBase    <>
26: d1     TDerived <>
27:
28: ;----- Define objects with explicit default values
29: ;      and place holders (0) for VMT pointers
30:
31: b2     TBase    <0, 987>
32: d2     TDerived <<0, 654>, 321>
33:
34: ;----- Define objects with explicit default values
35: ;      and explicit vmt pointers.
36:
37: b3     TBase    <@TableAddr_TBase, 987>
38: d3     TDerived <<@TableAddr_TDerived, 654>, 321>
39:
40:
41:     CODESEG
42:
43: Start:
44:     mov    ax, @data          ; Initialize DS to address
45:     mov    ds, ax            ; of data segment
46:

```

```
47:      mov     si, offset b1           ; Address instance b1
48:      LoadVMTSeg es                 ; Initialize es (VMT seg)
49:      CALL si METHOD TBase:construct  ; Prepare b1's VMT ptr
50:      CALL si METHOD TBase:init, 01h  ; Initialize instance data
51:      CALL TBase PTR si METHOD TBase:action ; Call virtual function
52:
53:      mov     si, offset d1           ; Address instance d1
54:      LoadVMTSeg es                 ; Initialize es
55:      CALL si METHOD TDerived:construct ; Static function call
56:      CALL si METHOD TDerived:init, 02h, 03h ; Static function call
57:      CALL TBase PTR si METHOD TBase:action ; Virtual function call
58:
59:      mov     si, offset d1           ; Address instance d1
60:      LoadVMTSeg es                 ; Initialize es
61:      CALL TBase PTR si METHOD TBase:action ; Calls TDerived:action
62:
63:      mov     si, offset b2           ; Address instance b2
64:      LoadVMTSeg es                 ; Initialize es
65:      CALL si METHOD TBase:construct  ; Prepare b2's VMT ptr
66:      CALL TBase PTR si METHOD TBase:action ; Calls TBase:action
67:
68:      mov     si, offset d2           ; Address instance d2
69:      LoadVMTSeg es                 ; Initialize es
70:      CALL si METHOD TDerived:construct ; Static function call
71:      CALL TBase PTR si METHOD TBase:action ; Calls TDerived:action
72:
73:      mov     si, offset b3           ; Address instance b3
74:      LoadVMTSeg es                 ; Initialize es
75:      CALL TBase PTR si METHOD TBase:action ; Calls TBase:action
76:
77:      mov     si, offset d3           ; Address instance d3
78:      LoadVMTSeg es                 ; Initialize es
79:      CALL TBase PTR si METHOD TBase:action ; Calls TDerived:action
80:
81: Exit:
82:      mov     ah, 04Ch                ; DOS function: Exit program
83:      mov     al, [exCode]            ; Return exit code value
84:      int     21h                    ; Call DOS. Terminate program
85:
86:      END     Start                  ; End of program / entry point
```

The sample listing demonstrates several key techniques of virtual methods:

- It shows how to write a memory-model-independent program.
- It shows three ways to define instances of objects that use virtual methods.
- It shows the proper way to initialize instances of objects that use virtual methods.
- It shows how to call virtual methods for object instances addressed by pointers (polymorphism).

You may change the memory model in line 9 to `small`, `large` (its current value), or `huge`. Other memory models may also work, but I tested only those three. I urge you to try at least the `small` and `large` models, and to examine the object instances in Turbo Debugger. You might also want to use TD's `View:Data` command to locate virtual method tables, which are configured differently, and stored in different segments, depending on the memory model.

Lines 13–17 include the `OOMACROS.INC`, `TBASE.INC`, and `TDERIVED.INC` files. When using the VMT macros, be sure to include `OOMACROS.INC` before declaring any objects.

Lines 25–26 show the standard way to define object instances. These definitions are the same as ones you have already examined—the fact that the objects have virtual methods has no bearing on how you define *uninitialized* instances of those objects.

If, however, you wish to override the default values of variables in your object definitions, you must also account for the VMT pointer in each of those instances. Lines 31–32 show one way to satisfy this rule. The first definition defines an instance, `b2`, of the `TBase` object. That instance's `TBase_data` variable is assigned the value 987. The instance's VMT pointer is given the value 0, a placeholder that will be changed when the program calls the object's constructor for `b2`.

Line 32 shows how to initialize a derived object and its inherited variables and VMT pointer, using nested angle brackets. The inner expression, `<0, 654>`, assigns zero to the inherited VMT pointer and 654 to the inherited `TBase_data` variable. The outer expression `<... ,321>` assigns 321 to the `TDerived_data` variable. As with `b2`, the derived-object instance's VMT pointer will be initialized when the program calls the object constructor for `d2`.

Lines 37–38 demonstrate an alternate technique for initializing object instances. When you declare an object and its associated VMT, Turbo Assembler creates a symbol that represents the VMT's address. The symbol is given the name

```
@TableAddr_<object name>
```

where `<object name>` is the object's declared name. For example, `@TableAddr_TBase` represents the address of the `TBase` object's VMT. `@TableAddr_TDerived` represents the address of the `TDerived` object's VMT.

You may use these symbols to completely initialize object instances as shown at lines 37–38. Line 37 initializes a base object; line 38 initializes a derived object using nested angle brackets as in the definition at line 32.

When defining objects this way, you do not have to call the object's constructors to initialize the VMT pointers. They are *already* initialized. But you should still write a constructor for objects that use virtual methods because you can use this alternate technique *only* with static objects defined in the program text. You cannot, for example, use the `method` to construct

an object for which you allocate some memory, perhaps by calling a DOS function. For that reason, I do not recommend using the technique illustrated at lines 37–38 except in special circumstances. Instead, use the techniques at lines 25–26 or 31–32 to define object instances, and always call the object’s constructor for *each* of those instances.

Lines 47–51 demonstrate how to do that for the first instance, `b1`, of the `TBase` object. Line 47 addresses the instance with `ds:si`. Line 48 is new—it uses the `LoadVMTSeg` macro to initialize register `es` to the segment where VMTs are stored. (This macro is strictly needed only in small memory-model programs. Its use, however, guarantees a model-independent result.)

Lines 49–50 construct and initialize the `b1` object instance. You *must* call the constructor as demonstrated at line 49 before calling any virtual methods. Failing to do so will almost certainly crash the program and may halt your computer’s operating system.

Compare the `CALL...METHOD` instructions in lines 50–51. The first of the two lines calls a static method, `init`, for the `TBase` object. The second line calls a virtual method, `action`, for the same object. Turbo Assembler uses the specified register (`si` in this case) to locate the object’s VMT (by using the VMT pointer stored in the instance), and to call the subroutine addressed by the VMT. By the way, you may use the same syntax to call static methods. In other words, you may rewrite line 50 as follows:

```
CALL TBase PTR si METHOD TBase:init, 01h
```

You might want to call *all* methods that way (prefacing `si` with your object name and `PTR`). You can then change methods from static to virtual simply by revising their object declarations. If a method will always be static, however, the `PTR` preface isn’t needed. It is required only to permit Turbo Assembler to generate instructions for accessing VMT entries.

It is instructive to examine the code that Turbo Assembler generates for a virtual method subroutine call such as the one at line 51. To do this with Turbo Debugger, type `make` to assemble and link the program, then type `td virtual` to load it into the debugger. Press F8 until the cursor reaches line 51. Then use the `view:CPU` command to view the generated instructions. (Press F5 to expand the window to full screen.)

Under the large memory model, you’ll find these instructions:

```
les    bx,[si]
call  es:far [bx]
```

The `les` instruction loads the 32-bit address stored at `ds:si` into registers `es:bx`. In other words, because the VMT pointer is the first data member in the instance, the instruction copies the VMT pointer’s value into `es:bx`. *This is why the VMT pointer must be the first member in an object instance.*

The second instruction performs an indirect `call` to *another* address. That address is, in this case, the first entry in the object’s VMT. If the object had other virtual methods, the generated `call` instruction would be something like this:

```
call es:far [bx+04]
```

The virtual method addresses are stored in the VMT, and the indirect call uses `es:bx`, possibly adjusted by adding an offset such as `04`, to load the subroutine address from the table. The actual call is made to that address. In this way, calls to virtual methods are redirected at runtime to the proper location.

Under the small memory model, Turbo Assembler generates a different sequence for the `CALL...METHOD` instruction at line 51:

```
mov bx,[si]
call es:[bx]
```

The first instruction loads the offset address of the object's VMT into `bx`, but the second instruction uses the *uninitialized* segment register `es` to locate the virtual method address. This might be a bug in Turbo Assembler, or even though the User Guide has no information on this subject, the assembler might simply expect `es` to be initialized to the segment that stores VMTs. Assuming the latter, the `LoadVMTseg` macro in `OOMACROS.INC` initializes `es` properly regardless of memory model. If you don't want to store your small-model VMTs in the code segment, you must be sure to initialize `es` to the proper segment address before calling virtual methods. It is probably easier, however, to use large model in which case you do not need to use `LoadVMTseg`.

The remainder of the program starting at line 53 (refer back to Listing 14.9, `oop\virtual\VIRTUAL.ASM`) demonstrates how to call constructors, static, and virtual methods for other object instances defined in the program's data segment. Run the program under Turbo Debugger, and add the program's instances `b1`, `d1`, `b2`, `d2`, `b3`, and `d3` to the *Watches* window (move the cursor to each instance and press `Ctrl+W`).

Next, press `F7` to trace each subroutine call. Do this in the *Module* window until you are familiar with the code, and then view the instructions in the *CPU* window to trace the actual instructions. You may want to open the *Registers* window using the *View* command to inspect register values.

Pay particular attention to the `CALL...METHOD` instructions at lines 57, 61, 66, 71, 75, and 79. Though each of these instructions is identical, the program calls `TBase_action` or `TDerived_action` depending on the type of object instance addressed by `ds:si`. This is polymorphism at work. The object instances themselves, by way of their VMTs, determine *at runtime* which virtual methods to call.

It is highly instructive to repeat these experiments in Turbo Debugger for different memory models. Change `large` to `small` at line 9, reassemble, and trace the results in Turbo Debugger. Notice the different sizes of VMT pointers, and also inspect the code generated for `CALL...METHOD` instructions.

Polymorphism

The listings in this section put polymorphism to practical use. The listings implement an object, `TList`, that can store lists of instances of another kind of object, `TItem`. After presenting these two objects, I'll explain how to derive new objects from `TItem` and insert them into a linked list.

NOTE

The technique of programming linked lists in assembly language is one the most requested subjects from readers of this book's first edition. You can, of course, program linked lists with conventional code, but using objects makes the job a lot easier, as the following modules and sample program demonstrate.

Creating a List Object

The first job in creating a list object is to invent a generic item to be stored on the list. The `TItem` object in Listing 14.10, `TITEM.INC`, is called an *abstract* object because it is never used to define object instances. To store an object on a list, you derive a new object from `TItem`. In this way, you can derive as many different kinds of objects you need and store them all on the same list. The list can handle *any* kind of information—all you need to do is derive your objects from `TItem`.

NOTE

The remaining listings in this chapter are located in the `OOP\LIST` subdirectory.

Listing 14.10. `oop\list\TITEM.INC`.

```
1: %TITLE "Titem object -- by Tom Swan"
2:
3: GLOBAL Titem_construct:PROC
4: GLOBAL Titem_init:PROC
5: GLOBAL Titem_print:PROC
6:
```

continues

Listing 14.10. continued

```

7: STRUC TItem METHOD {
8:   construct:mptr      = TItem_construct ; TItem constructor
9:   init:mptr           = TItem_init      ; TItem initializer
10:  VIRTUAL print:mptr   = TItem_print     ; Print or display item
11: }
12:  TBLPTR                               ; Virtual method table pointer
13:  next      dw  ?                       ; Pointer to next item
14: ENDS TItem
15:
16: Make_VMT          ; Define TItem VMT
17:
18: CODESEG
19:
20: ;-----
21: ; TItem_construct  TItem constructor
22: ;-----
23: ; Input:
24: ;   ds:si = TItem instance address
25: ; Output:
26: ;   VMT ptr initialized
27: ; Registers:
28: ;   none
29: ;-----
30: PROC  TItem_construct  PASCAL
31:     TBLINIT TItem PTR si          ; Initialize VMT pointer
32:     ret
33: ENDP  TItem_construct
34:
35: ;-----
36: ; TItem_init      Initialize item "next" pointer
37: ;-----
38: ; Input:
39: ;   ds:si = TItem instance address
40: ; Output:
41: ;   next field <- nil (0000)
42: ; Registers:
43: ;   none
44: ;-----
45: PROC  TItem_init  PASCAL
46:     mov  [(TItem PTR si).next], 0 ; Set next field to zero
47:     ret
48: ENDP  TItem_init
49:
50: ;-----
51: ; TItem_print     Print item                                VIRTUAL
52: ;-----
53: ; Input:
54: ;   ds:si = TItem instance address
55: ; Output:
56: ;   none
57: ; Registers:
58: ;   none
59: ;-----
60: PROC  TItem_print  PASCAL
61:     ret                    ; Instructions supplied by actual items
62: ENDP  TItem_print

```

Lines 7–14 in `TITEM.INC` declare the `TItem` object, which has a constructor (`construct`), an initializer (`init`), and a virtual method `print`. The object defines a VMT pointer (line 12), and also a variable `next` (line 13). The `next` variable represents the 32-bit address of the next item in the list. If this variable is zero, the item is the last (or only) listed value.

Line 16 creates a VMT for `TItem`. Remember: an object derived from `TItem` requires its own VMT, but it inherits the VMT pointer from `TItem`. Do not use the `TBLPTR` directive in objects derived from `TItem`. Do use the `Make_VMT` macro to define a VMT for your derived objects.

NOTE

The objects in this section require the `OOMACROS.INC` file in this chapter. On disk, this file is located in the `OOP` subdirectory.

A constructor method (lines 30–33) initializes a `TItem` object instance's VMT pointer. This code is similar to that in other constructors you have seen in this chapter.

`TItem`'s initializer (lines 45–48) sets the `next` variable in object instances to zero, the value that indicates no next object in the list. In your derived objects, be sure to call `TItem: init` to initialize the inherited `next` variable.

`TItem`'s virtual `print` method (lines 60–62) performs no action. Derived objects are expected to replace this method with code that is appropriate to the type of stored information. `TItem_print` is called an *abstract method*. It serves merely as a placeholder for actions to be defined in derived objects.

Listing 14.11, `TLIST.INC`, declares and implements the `TList` object, which manages a linked list of `TItem` object instances (or any instances of objects derived from `TItem`). `TList`'s methods are a bit more complex than others in this chapter. If you have trouble following the line-by-line discussion after the listing, load the sample host program (the last listing in the chapter) into Turbo Debugger and trace the methods in `TList`.

Listing 14.11. oop\list\TLIST.INC.

```
1: %TITLE "TList object -- by Tom Swan"
2:
3: GLOBAL TList_construct:PROC
4: GLOBAL TList_init:PROC
5: GLOBAL TList_getCount:PROC
6: GLOBAL TList_insertItem:PROC
7: GLOBAL TList_printAll:PROC
8:
```

continues

Listing 14.11. continued

```

 9: STRUC TList METHOD {
10:   construct:mptr      = TList_construct ; TList constructor
11:   init:mptr          = TList_init      ; TList initializer
12:   getCount:mptr      = TList_getCount  ; Return number of items
13:   VIRTUAL insertItem:mptr = TList_insertItem ; Insert TItem into list
14:   VIRTUAL printAll:mptr = TList_printAll ; Print or display all items
15: }
16: TBLPTR                                ; Virtual method table pointer
17:   root      dw ?                       ; Ptr to first item in list
18:   num       dw ?                       ; Number of listed items
19: ENDS TList
20:
21: Make_VMT          ; Define TList VM
22:
23: CODESEG
24:
25: ;-----
26: ; TList_construct  TList constructor
27: ;-----
28: ; Input:
29: ;   ds:si = TList instance address
30: ; Output:
31: ;   VMT ptr initialized
32: ; Registers:
33: ;   none
34: ;-----
35: PROC   TList_construct PASCAL
36:       TBLINIT TList PTR si           ; Initialize VMT pointer
37:       ret
38: ENDP   TList_construct
39:
40: ;-----
41: ; TList_init      Initialize list to empty state
42: ;-----
43: ; Input:
44: ;   ds:si = TList instance address
45: ; Output:
46: ;   root field <- nil (0000) (empty list)
47: ; Registers:
48: ;   none
49: ;-----
50: PROC   TList_init PASCAL
51:       mov  [(TList PTR si).root], 0 ; Set root to zero (empty)
52:       mov  [(TList PTR si).num], 0  ; Set num items to zero
53:       ret
54: ENDP   TList_init
55:
56: ;-----
57: ; TList_getCount  Return number of listed items
58: ;-----
59: ; Input:
60: ;   ds:si = TList instance address
61: ; Output:
62: ;   ax = number of items in list
63: ; Registers:
64: ;   ax
65: ;-----

```

```

66: PROC   TList_getCount  PASCAL
67:       mov    ax, [(TList PTR si).num] ; Get num field from list
68:       ret
69: ENDP   TList_getCount
70:
71: ;-----
72: TList_insertItem  Insert an item into the list      VIRTUAL
73: ;-----
74: ; Input:
75: ;       ds:si = TList instance address
76: ;       arg  = Titem 16-bit address (offset into data segment)
77: ; Output:
78: ;       Item instance linked into list
79: ; Registers:
80: ;       none
81: ;-----
82: PROC   TList_insertItem  PASCAL
83:       ARG    @item:word ; Stack offset to argument
84:       USES   ax, bx      ; Preserve ax and bx
85:       mov    ax, [(TList PTR si).root] ; Set ax to list root ptr
86:       mov    bx, [@item] ; Set bx to item ptr
87:       mov    [(TItem PTR bx).next], ax ; Set item.next = root
88:       mov    [(TList PTR si).root], bx ; Set list.root = item ptr
89:       inc    [(TList PTR si).num] ; Increment num items
90:       ret
91: ENDP   TList_insertItem
92:
93: ;-----
94: TList_printAll    Call print for all listed items  VIRTUAL
95: ;-----
96: ; Input:
97: ;       ds:si = TList instance address
98: ; Output:
99: ;       depends on items' print methods
100: ; Registers:
101: ;       none
102: ;-----
103: PROC   TList_printAll  PASCAL
104:       USES   si, es ; Preserve registers
105:       LoadVMTSeg es ; Initialize es (optional*)
106:       mov    si, [(TList PTR si).root] ; Set si to list root ptr
107: @e10:
108:       or     si, si ; Test si for 0 (nil)
109:       jz     @e99 ; Jump to exit if si = 0
110:       CALL  TItem PTR si METHOD Titem:print ; Call item's print method!
111:       mov    si, [(TItem PTR si).next] ; Set si to next item ptr
112:       jmp   @e10 ; Loop until done
113: @e99:
114:       ret
115: ENDP   TList_printAll
116:
117: ; * Optional depending on memory model

```

The `TList` object (lines 9–19) declares three static and two virtual methods. The object also defines a VMT pointer (line 16) and two variables: `root`, which addresses the first `TItem` instance in the list (or is zero if the list is empty), and `num`, which holds the number of listed objects. Line 21 defines a VMT for `TList`.

NOTE

`TList` is not derived from `TItem`—the two objects are separate and distinct. But see Project 14.1 for a variation on this theme.

As in all of this chapter's objects that have at least one virtual method, `TList`'s constructor (lines 35–38) initializes a `TList` instance's VMT pointer by using the `TBLINIT` directive.

`TList`'s initializer (lines 50–54) sets the two variables, `root` and `num`, to zero. Programs should define a `TList` object instance, address that instance with `ds:si`, and call the object's constructor and initializer before inserting any `TItem` instances into the list.

Method `TList_getCount` (lines 66–69) returns in register `ax` the number of items in a list. This value is convenient for writing loops that perform actions on listed items.

Method `TList_insertItem` (lines 82–91) inserts an instance of an object derived from `TItem` into a list. Pass the offset address of the `TItem`-derived instance as an argument to the method. Line 85 sets `ax` to the current list `root`, which points to the first item (if any) on the list. Line 86 assigns to `bx` the passed argument offset of the new instance to be inserted in the list.

Lines 87–88 insert the `TItem` instance into the list. This is done by setting the item's inherited `next` pointer to the address of the first item currently on the list (or to zero if the list is empty). After that, the `root` is set to the address of the new item, which becomes the new first listed item. Finally, line 89 increments `num` to keep account of the number of listed items.

Virtual method `TList_printAll` demonstrates a good use for polymorphism. This method uses `ds:si` to address a list's first item (lines 105–106). (The `LoadVMTSeg` macro at line 105 is needed only for small memory model programs, but is included so that the `TList` and `TItem` objects can be used with any memory models.)

The loop at lines 107–112 addresses each item in the list. First, line 108 checks whether `si` is zero, indicating that the last item has been processed, or that the list is empty. If `si` is zero, line 109 jumps out of the loop, ending the method. Otherwise, line 110 calls the item's virtual print method.

Because that method is virtual, the actual print method that is called *depends on the type of item on the list*. In an object derived from `TItem`, you should insert your own print method to perform whatever action you want. `TList`'s `printAll` method will call your object's print method from line 110.

Line 111 assigns the next variable from the current item to `si`, after which line 112 jumps to restart the loop. In this way, all items are processed by following their next pointers.

Using the List Object

To use the `TList` object, we first need some objects to store on a list. All such items must be derived from `TItem`, but there are no other significant restrictions. You can easily store *any* kind of data on a list, and you can mix different types of object instances on the *same* list—features that are difficult to program using conventional assembly language techniques.

Listing 14.12, `TINTOBJ.INC`, shows an example of an object, `TIntObj`, derived from `TItem`. The new object stores an integer value. Use it to create lists of 16-bit integers.

Listing 14.12. `oop\list\TINTOBJ.INC`.

```

1: %TITLE "TIntObj object -- by Tom Swan"
2:
3: GLOBAL TIntObj_construct:PROC
4: GLOBAL TIntObj_init:PROC
5: GLOBAL TIntObj_print:PROC
6:
7: STRUC TIntObj TItem METHOD {
8:   construct:mptr      = TIntObj_construct ; TIntObj constructor
9:   init:mptr           = TIntObj_init     ; TIntObj initializer
10:  VIRTUAL print:mptr  = TIntObj_print     ; Print or display item
11: }
12:   data_i             dw      ?           ; 16-bit integer data
13: ENDS  TIntObj
14:
15: Make_VMT             ; Define TIntObj VMT
16:
17: DATASEG
18:
19: TIntObj_buffer       db      20 DUP (0)
20: TIntObj_msg          db      'Integer item = ', 0
21:
22: CODESEG
23:
24: ;----- From BINASC.OBJ, STRIO.OBJ
25:   EXTRN  BinToAscHex:Proc, NewLine:Proc, StrWrite:Proc
26:
27: ;-----
28: ; TIntObj_construct  TIntObj constructor
29: ;-----
30: ; Input:
31: ;   ds:si = TIntObj instance address
32: ; Output:
33: ;   VMT ptr initialized
34: ; Registers:
35: ;   none
36: ;-----

```

continues

Listing 14.12. continued

```

37: PROC   TIntObj_construct PASCAL
38:       TBLINIT TIntObj PTR si           ; Initialize VMT pointer
39:       ret
40: ENDP   TIntObj_construct
41:
42: ;-----
43: ; TIntObj_init           Initialize item "next" pointer
44: ;-----
45: ; Input:
46: ;       ds:si = TIntObj instance address
47: ;       arg   = 16-bit integer to store in instance
48: ; Output:
49: ;       instance.data_i <- arg
50: ; Registers:
51: ;       none
52: ;-----
53: PROC   TIntObj_init PASCAL
54:       ARG     @data:word
55:       USES    ax
56:       CALL    si METHOD TItem:init       ; Call TItem ancestor init
57:       mov     ax, [@data]                ; Get argument from stack
58:       mov     [(TIntObj PTR si).data_i], ax ; Assign arg to instance
59:       ret
60: ENDP   TIntObj_init
61:
62: ;-----
63: ; TIntObj_print         Print item                                VIRTUAL
64: ;-----
65: ; Input:
66: ;       ds:si = TIntObj instance address
67: ; Output:
68: ;       none
69: ; Registers:
70: ;       none
71: ;-----
72: PROC   TIntObj_print PASCAL
73:       USES    ax, cx, di, es             ; Preserve registers
74:       push    ds                          ; Set es equal to ds
75:       pop     es                          ; for extrn subroutines
76:       mov     di, offset TIntObj_msg      ; Address label string
77:       call    StrWrite                     ; Display string
78:       mov     ax, [(TIntObj PTR si).data_i] ; Get instance integer data
79:       mov     cx, 1                        ; Minimum digits to output
80:       mov     di, offset TIntObj_buffer   ; Address working string
81:       call    BinToAscHex                  ; Convert integer to string
82:       call    StrWrite                     ; Display string
83:       call    NewLine                      ; Start new display line
84:       ret
85: ENDP   TIntObj_print

```

The TIntObj object (lines 7–13) inherits the members from TItem. The new object provides its own constructor and initializer methods (lines 8–9), and also replaces the virtual print

method. Remember, `TItem`'s `print` method is a mere placeholder—the `print` method in the derived object will perform the real action when a program calls a list's `printAll` method.

`TIntObj` defines a variable, `data_i`, at line 12 for holding the item's integer value. `TIntObj` inherits the VMT pointer from `TItem`, so it is not necessary to insert a `TBLPTR` directive in the object declaration (in fact, doing so would be an error). `TIntObj` also inherits the `next` variable from `TItem`, thus a `TIntObj` instance has the capability of being linked into a list.

Line 15 uses the `Make_VMT` macro to create a VMT for `TIntObj`. I've said this before, but I'll hammer it home again. A derived object inherits a VMT pointer, but not a VMT. All objects, including derived and base object, that have one or more virtual methods must define their own VMTs.

Lines 19–20 define a string buffer and a string message for use in the object's methods. These values are collected into the main program's data segment.

Line 22 continues the module's code segment, after which lines 24–25 declare three external subroutines used by object methods. These subroutines are from the `BINASC.OBJ` and `STRIO.OBJ` modules from this book. The assembled modules are in the `MTA.LIB` library file, supplied on the book's disk. Any program that uses `TIntObj` must be linked to that library. (A sample program at the end of this chapter shows the necessary steps.)

The `TIntObj` constructor (lines 37–40) initializes an object instance's VMT pointer—the same task performed by all constructors in this chapter's sample objects.

`TIntObj`'s initializer demonstrates an important OOP technique for derived objects. The derived object's `init` method has two jobs: it must call the base object's `init` method to initialize variables declared for `TItem` (and inherited by the derived object), and it must initialize its own data.

The first job—calling the ancestor object method—takes place at line 56. `TItem:init` requires no arguments, and because `ds:si` already address an object instance, a single `CALL...METHOD` directive satisfies this requirement.

The second job—initializing the derived object's own data—takes place at lines 57–58. First, the passed argument is assigned to `ax`, which is then assigned to the object instance's `data_i` variable. By the way, you may replace these two lines with the single instruction:

```
mov [(TIntObj PTR si).data_i], [@@data]
```

`TIntObj`'s replacement virtual method `TIntObj_print` uses the string and binary-to-ASCII subroutines from this book to display an object instance's integer value. The code also demonstrates that you can easily mix object-oriented and conventional subroutines. You must be careful to preserve register values—especially `ds:si` and `es`, which address object instances and VMT segments, but the programming is otherwise straightforward.

Lines 76–77 display the string "Integer item =", defined at the beginning of the module (line 20). Line 78 loads `ax` with the object instance's `data_i` integer value, which is converted to string form by `BinToAscHex`, and stored in a buffer (line 19). Lines 82–83 display this buffer and start a new display line.

Lists are not limited to storing integer data—simply by deriving a new object from `TItem`, it's possible to store any other kind of data as well. For example, Listing 14.13, `TSTROBJ.INC`, shows how to create a string object. With the `TStrObj` object in this module, and with the `TIntObj` object from the preceding section, you can create lists of strings *and* integers.

Listing 14.13. `oop\list\TSTROBJ.INC`.

```

1: %TITLE "TStrObj object -- by Tom Swan"
2:
3: GLOBAL TStrObj_construct:PROC
4: GLOBAL TStrObj_init:PROC
5: GLOBAL TStrObj_print:PROC
6:
7: STRUC TStrObj TItem METHOD {
8:   construct:mptr   = TStrObj_construct ; TStrObj constructor
9:   init:mptr       = TStrObj_init     ; TStrObj initializer
10:  VIRTUAL print:mptr = TStrObj_print   ; Print or display item
11: }
12:   data_s          dw      ?           ; Ptr to null-terminated string
13: ENDS TStrObj
14:
15: Make_VMT          ; Define TStrObj VMT
16:
17: DATASEG
18:
19: TStrObj_msg       db      'String item = ', 0
20:
21: CODESEG
22:
23: ;----- From STRIO.OBJ
24:   EXTRN NewLine:Proc, StrWrite:Proc
25:
26: ;-----
27: ; TStrObj_construct TStrObj constructor
28: ;-----
29: ; Input:
30: ;   ds:si = TStrObj instance address
31: ; Output:
32: ;   VMT ptr initialized
33: ; Registers:
34: ;   none
35: ;-----
36: PROC TStrObj_construct PASCAL
37:   TBLINIT TStrObj PTR si           ; Initialize VMT pointer
38:   ret
39: ENDP TStrObj_construct

```

```

40:
41: ;-----
42: ; TStrObj_init      Initialize item "next" pointer
43: ;-----
44: ; Input:
45: ;     ds:si = TStrObj instance address
46: ;     arg  = 16-bit offset to string in data segment
47: ; Output:
48: ;     instance.data_s <- arg
49: ; Registers:
50: ;     none
51: ;-----
52: PROC    TStrObj_init PASCAL
53:     ARG    @@data:word
54:     USES   ax
55:     CALL   si METHOD TItem:init          ; Call TItem ancestor init
56:     mov    ax, [@@data]                 ; Get argument from stack
57:     mov    [(TStrObj PTR si).data_s], ax ; Assign arg to instance
58:     ret
59: ENDP    TStrObj_init
60:
61: ;-----
62: ; TStrObj_print      Print item                                VIRTUAL
63: ;-----
64: ; Input:
65: ;     ds:si = TStrObj instance address
66: ; Output:
67: ;     none
68: ; Registers:
69: ;     none
70: ;-----
71: PROC    TStrObj_print PASCAL
72:     USES   di, es ; Preserve registers
73:     push  ds      ; Set es equal to ds
74:     pop   es      ; for extrn subroutines
75:     mov   di, offset TStrObj_msg ; Address label string
76:     call  StrWrite ; Display string
77:     mov   di, [(TStrObj PTR si).data_s] ; Get instance string ptr
78:     call  StrWrite ; Display string
79:     call  NewLine  ; Start new display line
80:     ret
81: ENDP    TStrObj_print

```

TStrObj (lines 7–13) mirrors the design of TIntObj. Both objects are derived from TItem, and both declare similar static and virtual methods. Line 12, however, defines a `data_s` variable, which represents the offset to a string. (You might also store string data directly in an object—TStrObj demonstrates just one of countless possible techniques for storing data in objects.)

Line 15 uses the `Make_VMT` macro to create a VMT for the TStrObj. Okay, I promise, this is the last time I'll mention these rules: *derived objects inherit VMT pointers; they don't inherit VMTs.*

Line 19 defines a string message to display when `TStrObj` object instances are printed. Line 24 imports two `MTA.LIB` library routines for starting a new display line and for writing a string to the standard output file.

NOTE

Multiple modules such as `TINTOBJ.INC` and `TSTROBJ.INC` may duplicate the same `EXTRN` declarations without harm. Only one copy of each subroutine is linked to the final program.

`TStrObj`'s constructor (lines 36–39) performs the usual job of initializing an object instance's VMT pointer using the `TBLINIT` directive.

`TStrObj`'s initializer (lines 52–59) calls the `TItem init` method to initialize inherited data, and assigns to `data_s` the passed word argument, which represents a string's offset address (lines 56–57).

Finally in the new module, lines 71–81 implement `TStrObj`'s virtual `print` method. As in `TIntObj`'s `print` method, some register manipulation is necessary to preserve `es` and `si`, but the rest of the programming is straightforward. Lines 75–76 display the message defined at the beginning of the module. Lines 77–79 display the `TStrObj` instance's string data and start a new output line.

At this stage, you now have all of the components needed to create a list of string and integer data. The sample host program in Listing 14.14, `LIST.ASM`, demonstrates how to combine the preceding elements into a finished application. You may now assemble and run the demonstration. Change to the `OOP\LIST` directory and type `make`, or enter these commands (modify the directory path to the `MTA.LIB` library file, provided on the book's disk, as necessary):

```
tasm /zi list
tlink /v list,,, ..\..\MTA.LIB
```

Listing 14.14. oop\list\LIST.ASM.

```
1: %TITLE "List object demonstration -- by Tom Swan"
2:
3:     IDEAL
4:
5:     JUMPS
6:
7:     LOCALS @@
8:
9:     MODEL small, PASCAL
10:
11:     STACK 1000H
12:
```

```
13:      INCLUDE "..\oomacros.inc"
14:
15:      INCLUDE "titem.inc"
16:
17:      INCLUDE "tlist.inc"
18:
19:      INCLUDE "tintobj.inc"
20:
21:      INCLUDE "tstrobj.inc"
22:
23:      DATASEG
24:
25: exCode db      0          ; Program exit code
26:
27: ;----- Define list instance
28:
29: list   TList   <>
30:
31: ;----- Define integer item instances
32:
33: i1     TIntObj <>
34: i2     TIntObj <>
35: i3     TIntObj <>
36:
37: ;----- Define string item instances
38:
39: s1     TStrObj <>
40: s2     TStrObj <>
41:
42: ;----- Define static strings for string instances
43:
44: str1   db      'Some colors: Red, White, Blue', 0
45: str2   db      'Some days: Monday, Tuesday, Friday', 0
46:
47: ;----- Define various program strings
48:
49: str3   db      'After initializing list...', 0
50: str4   db      'After inserting integer items...', 0
51: str5   db      'After inserting string items...', 0
52: strNum db      'Number of items in list = ', 0
53: strBuf db      20 DUP (0)
54:
55:      CODESEG
56:
57: ;----- From BINASC.OBJ, STRIO.OBJ
58:      EXTRN   BinToAscDec:Proc, NewLine:Proc, StrWrite:Proc
59:
60: Start:
61:      mov    ax, @data      ; Initialize DS to address
62:      mov    ds, ax        ; of data segment
63:
64: ;----- Initialize the list instance
65:
```

continues

Listing 14.14. continued

```
66:      mov     si, offset list
67:      LoadVMTSeg es
68:      CALL    si METHOD TList:construct
69:      CALL    si METHOD TList:init
70:
71:      mov     di, offset str3
72:      call    DisplayItems
73:
74: ;----- Initialize integer item instances
75:
76:      mov     si, offset i1
77:      LoadVMTSeg es
78:      CALL    si METHOD TIntObj:construct
79:      CALL    si METHOD TIntObj:init, 01h
80:
81:      mov     si, offset i2
82:      LoadVMTSeg es
83:      CALL    si METHOD TIntObj:construct
84:      CALL    si METHOD TIntObj:init, 02h
85:
86:      mov     si, offset i3
87:      LoadVMTSeg es
88:      CALL    si METHOD TIntObj:construct
89:      CALL    si METHOD TIntObj:init, 03h
90:
91: ;----- Initialize string item instances
92:
93:      mov     si, offset s1
94:      LoadVMTSeg es
95:      CALL    si METHOD TStrObj:construct
96:      CALL    si METHOD TStrObj:init, offset str1
97:
98:      mov     si, offset s2
99:      LoadVMTSeg es
100:     CALL    si METHOD TStrObj:construct
101:     CALL    si METHOD TStrObj:init, offset str2
102:
103: ;----- Insert integer item instances into list
104:
105:     mov     si, offset list
106:     LoadVMTSeg es
107:     mov     ax, offset i1
108:     call    InsertItem
109:     mov     ax, offset i2
110:     call    InsertItem
111:     mov     ax, offset i3
112:     call    InsertItem
113:
114:     mov     di, offset str4
115:     call    DisplayItems
116:
117: ;----- Insert string item instances into list
118:
```

```

119:      mov     ax, offset s1
120:      call    InsertItem
121:      mov     ax, offset s2
122:      call    InsertItem
123:
124:      mov     di, offset str5
125:      call    DisplayItems
126:
127: Exit:
128:      mov     ah, 04Ch      ; DOS function: Exit program
129:      mov     al, [exCode]  ; Return exit code value
130:      int     21h          ; Call DOS. Terminate program
131:
132: ;-----
133: ; InsertItem          Insert object instance into list
134: ;-----
135: ; Input:
136: ;     ax = offset to instance in data segment
137: ; Output:
138: ;     none
139: ; Registers:
140: ;     si
141: ;-----
142: PROC   InsertItem     PASCAL
143:      mov     si, offset list
144:      LoadVMTSeg es
145:      CALL   TList PTR si METHOD TList:insertItem, ax
146:      ret
147: ENDP   InsertItem
148:
149: ;-----
150: ; DisplayItems       Display all listed items
151: ;-----
152: ; Input:
153: ;     di = address of string message
154: ; Output:
155: ;     none
156: ; Registers:
157: ;     none
158: ;-----
159: PROC   DisplayItems  PASCAL
160:      USES   es
161:
162:      mov     si, offset list      ; Address list instance
163:      LoadVMTSeg es              ; Prepare es register
164:      CALL   si METHOD TList:getCount ; Get num items in list
165:      push    ax                  ; Save result on stack
166:
167:      push    ds                  ; Make es = ds for
168:      pop     es                  ; extrn subroutines
169:      call    NewLine             ; Start new display line
170:      call    StrWrite            ; Display message at di
171:      call    NewLine             ; Start new display line
172:

```

continues

Listing 14.14. continued

```

173:      mov    di, offset strNum      ; Address num items label
174:      call   StrWrite                ; Display label
175:
176:      pop    ax                      ; Get number of listed items
177:      mov    cx, 1                   ; Minimum digits to output
178:      mov    di, offset strBuf       ; Address working string
179:      call   BinToAscDec             ; Convert integer to string
180:      call   StrWrite                ; Display string
181:      call   NewLine                 ; Start new display line
182:
183:      mov    si, offset list          ; Address list instance
184:      LoadVM TSeg es                ; Prepare es register
185:      CALL   TList PTR si METHOD TList:printAll ; Display all items
186:      ret
187: ENDP   DisplayItems
188:
189:      END    Start                   ; End of program / entry point

```

Running the LIST demonstration program produces the following output on-screen:

```

After initializing list...
Number of items in list = 0

After inserting integer items...
Number of items in list = 3
Integer item = 3
Integer item = 2
Integer item = 1

After inserting string items...
Number of items in list = 5
String item = Some days: Monday, Tuesday, Friday
String item = Some colors: Red, White, Blue
Integer item = 3
Integer item = 2
Integer item = 1

```

Those lines illustrate that a list may be empty, contain objects of one type (integers), and also contain objects of different types (integers and strings). The number of objects on the list is reported in each case.

All of those operations are handled almost entirely by the `TItem`, `TList`, `TIntObj`, and `TStrObj` objects and methods. In addition, the messages you see on-screen are displayed by virtual print methods, which demonstrate how polymorphism alters the program's actions simply by plugging objects into a list.

NOTE

For a better understanding of the programming in this section, run the LIST demonstration in Turbo Debugger (enter `td list`) and trace the code in the `TItem`, `TList`, `TIntObj`, and `TStrObj` object methods. Also add the list and other object instances to the *Watches* window, or inspect their values with the *Data|Inspect* command (move the cursor to them and press `Ctrl+W` or `Ctrl+I`).

Line 9 selects the `small` memory model for the demonstration program. Although you may assemble the program for the `large` or `huge` models (the `TItem` and `TList` objects work with any memory model), because the demonstration program calls subroutines in `MTA.LIB`, it must be assembled for the `small` model.

NOTE

If you want to use the `large` model for the LIST demonstration, you will first have to reassemble all modules in `MTA.LIB` and rebuild the library. To do that, modify the `MODEL` directives in the library's modules, and use the `MAKEASM.MAK` file to rebuild the library (enter the command `make -fmakeasm.mak`). Refer to the beginning of file `MAKEASM.MAK` for a list of the library's source code modules.

Line 1 includes the `OOMACROS.INC` file, which defines memory-model-independent macros used by the program's objects. The program includes the object modules at lines 15–21.

Line 29 defines the program's `TList` instance, `list`. There's only one list in this demonstration, but there's no restriction on the number of lists that a program can define.

The program also needs a few instances to insert into the list. Lines 33–35 define three integer instances of the `TIntObj` object. Lines 39–40 define two string instances of the `TStrObj` object. Object instances could also be stored in memory buffers—simply use `ds:si` to address a space of an appropriate size, and call the object constructor and initializer methods to prepare that space. You could obtain the memory by calling a DOS function, or you could start a new data segment. The location of object instances is up to you.

Lines 49–53 define a few miscellaneous strings and a string buffer for messages displayed at runtime. These messages indicate which part of the program is running.

Lines 66–69 initialize the `list` object instance by addressing it with `ds:si` and by calling the `TList` constructor and initializer methods. The list is now ready to accept instances of objects derived from `TItem`.

Lines 71–72 display the current state of the list, which is empty at this stage. On-screen, you see these messages (press `Alt+F5` if you are running Turbo Debugger, then press any key to return):

```
After initializing list...
Number of items in list = 0
```

For simplicity, a local subroutine, `DisplayItems` (lines 159–187), produces that display. In the subroutine, lines 162–165 call the `TList` `getCount` method to obtain the number of items in the list. That value is converted to a string and displayed at lines 167–181. Next, lines 183–185 call the list's `printAll` method, which calls each virtual `print` method for all items on the list. *The listed objects themselves determine which virtual print method is called.* Use Turbo Debugger to trace the `CALL...METHOD` instruction at line 185 for an eye-opening and practical demonstration of polymorphism.

Return to the main listing at lines 76–89, which initialize the program's three integer object instances. Lines 93–101 similarly initialize the two string object instances. As I mentioned, you must call the constructor and initializer methods for *every* object instance. Each instance has its own VMT pointer, which must be individually initialized to the address of the object's VMT. Each instance also has its own variables. All of these elements must be properly initialized before using the object instances in any other way.

Lines 105–112 insert the three integer instances into the list. This is done simply by passing the offset address of each instance to the list's `InsertItem` method. After those instructions, lines 114–115 again call the local `DisplayItems` subroutine—this time, however, the list has three integer items, and on-screen, you see the messages:

```
After inserting integer items...
Number of items in list = 3
Integer item = 3
Integer item = 2
Integer item = 1
```

Be sure to understand that the final three lines are displayed by the `TIntObj` virtual `print` method. The program, however, doesn't call that method directly—instead, *the object instances themselves determine which method to call.*

Lines 119–122 continue the demonstration by inserting the program's string instances into the list. Again, this is simply done by passing the offset address of each instance to the `TList`

object's `InsertItem` method. Lines 124–125 then call `DisplayItems` again to display the list's current state. On-screen, you see:

```
After inserting string items...
Number of items in list = 5
String item = Some days: Monday, Tuesday, Friday
String item = Some colors: Red, White, Blue
Integer item = 3
Integer item = 2
Integer item = 1
```

The list now has five items—two strings and three integers. You could add more instances to the list, and you could derive other kinds of objects from `TItem` to list different information. All you need to do is derive a new object from `TItem` and implement its methods. At a minimum, the object needs a constructor, an initializer, and a virtual `print` method.

Other OOP Tips and Tidbits

So far, I purposely restricted this chapter to the information required to write OOP applications in assembly language. The following tips and tidbits are for advanced programmers who want to go beyond the fundamentals, and also for those who want a better understanding of how Turbo Assembler creates and uses object instances.

A Bug in the Debugger

When debugging OOP code, be aware of an apparent bug in Turbo Debugger that can crash your system. The bug can cause the computer to lock horns, and it might halt DOS or Windows.

You may be experiencing this problem if TD halts with an unhandled exception `00`, which is apparently due to the debugger not setting register `es` properly when inspecting some kinds of object instances. The error seems to occur when inspecting instances of a derived object that does not declare any new data members. Attempting to inspect or watch an instance of such a derived object raises the exception.

To work around the problem, define a dummy data byte or word in the derived object. For example, design your derived object like this:

```
STRUC TDerived TBase METHOD {
; methods
}
    dummy_data dw ? ; Temporary: remove from final code
ENDS TDerived
```

You may remove the dummy data after debugging. You might also use conditional assembly directives to remove the data declaration automatically from your final application.

NOTE

Perhaps some bright young programmer at Borland—actually, all programmers I’ve ever met at Borland are bright and young—may fix the bug by the time you read this section. If you can’t reproduce the problem, don’t worry about it.

More on VMT Pointers

A VMT pointer is a 16- or 32-bit variable that addresses an object’s VMT. Each instance of an object that has one or more virtual methods must have a VMT pointer. There’s only one VMT, however, for any single object. All instances of the same object share that same VMT. Figure 14.5 illustrates how object instances, VMT pointers, and VMTs appear conceptually in memory.

Figure 14.5.

Each instance of an object has a VMT pointer, which addresses the first entry of the object’s VMT. The entries in the VMT address the object’s virtual methods.

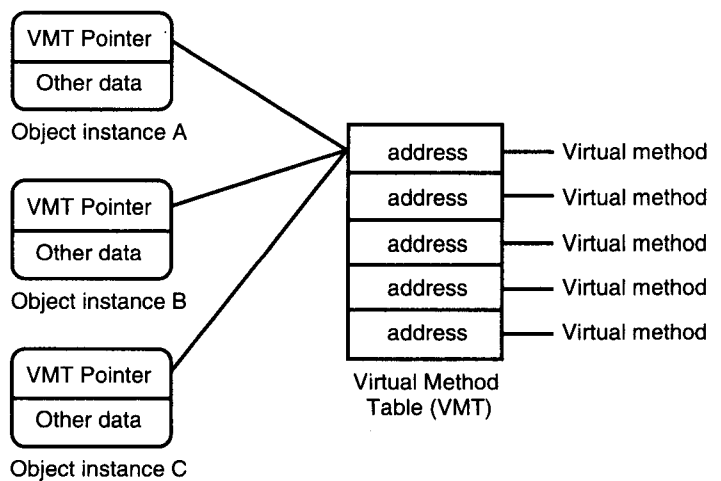

Turbo Assembler’s `TBLPTR` directive names VMT pointers `@MPTR_<object_name>`. For example, `TITEM`’s VMT pointer is named `@MPTR_TITEM`. Any derived objects (`TIntObj` and `TStrObj`, for instance) inherit this pointer.

HINT

Assemble the `LIST.ASM` program with the `/1a` option, and inspect the resulting `LIST.LST` file for a comprehensive list of the symbols that Turbo Assembler generates for object-oriented programs.

The generated pointer symbols represent offsets into the object structure. The actual VMT pointers are 16-bit words in small memory model programs, and 32-bit double words in large and huge model programs. The following fragment from the listing file shows the structure of `TITEM` and `TSTROBJ` objects. Notice how `TSTROBJ` inherits the VMT pointer (`@MPTR_TITEM`) and `NEXT` variables from `TITEM`. The word values are the offsets into the object structures that the symbols represent.

```
TITEM
@MPTR_TITEM      Word  0000
NEXT             Word  0002
TSTROBJ
@MPTR_TITEM      Word  0000
NEXT             Word  0002
DATA_S           Word  0004
```

There are two important facts to learn from this information. One, a VMT pointer must be the first data element in an object. Two, an object consists *only* of data. Despite the fact that objects encapsulate code and data, in reality, object instances contain only data. The association of code is handled strictly in the source text (for static methods), and by way of VMT pointers (for virtual methods).

Initializing a VMT Pointer

You may use the information in the preceding section to initialize a VMT pointer differently from the standard method, which uses the `TBLINIT` directive. Given an object `TBase`, for example, you can use code something like this (`ds:si` addresses the instance to be initialized):

```
mov     word ptr [si.@Mptr_TBase], offset @TableAddr_TBase
if @CodeSize eq 1
mov     word ptr [si.@Mptr_TBase+2], seg @TableAddr_TBase
endif
```

In small memory models, the first `mov` instruction assigns to the object instance's VMT pointer the VMT address represented as `@TableAddr_TBase`.

In large and huge models, the first `mov` instruction initializes the offset portion of the VMT pointer. The third line, after the conditional `if` directive, initializes the pointer's segment value. The preceding code is generated by the directive:

```
TBLINIT [si]
```

NOTE

Turbo Assembler's User's Guide does not use brackets around the `TBLINIT` argument, which causes the documented example to fail in Ideal mode.

Calling Ancestor Virtual Methods

From inside a virtual method in a derived object, to call the base object's virtual method, always use a static function call. *Do not use CALL...METHOD*. For example, in a derived object's virtual method action, to call the base object's action method, use code like this:

```
PROC TDerived_action PASCAL
    call    TBase_action    ; Call replaced base-object virtual method
    ret
ENDP TDerived_action
```

The important observation here is that virtual methods are just subroutines like any other. They are addressed, however, by entries in the object's VMT, which is addressed by the object *instance's* VMT pointer. If you insert something like this in place of the preceding call, your code is likely to hang or crash:

```
CALL TBase PTR si METHOD TBase:action ; ???
```

That may seem to be the correct way to call an ancestor object's virtual method, but because the ds:si registers address the *derived* object instance, the instruction actually makes a recursive call to the derived method—the same one that is attempting to call the ancestor method. As a result, the stack quickly overflows with return addresses and the program fails.

If you experience stack overflows in object-oriented programs, the likely cause is a virtual method that attempts to call its inherited ancestor virtual method of the same name using CALL...METHOD. Replace that code with a static call instruction to the method subroutine.

VMTs and Segment Addressing

By convention, object instances are addressed by ds:si. This is not a hard and fast rule, but it's the convention I adopted for this chapter, and I recommend that you address *all* instances consistently. Using a variety of register combinations to address object instances is simply too confusing.

Be aware also that Turbo Assembler uses segment register es to address VMTs. For this reason, it can be difficult to use es to address object instances.

As usual in assembly language, register assignments are up to you to make. However, I've found that using ds:si to address object instances, and reserving es to address VMTs, leads to the most reliable results.

Calling Virtual Methods without CALL...METHOD

You may call virtual methods without CALL...METHOD. For example, in small memory model programs, you may use code such as this:

```

push  cs      ; Push code segment register
pop   es      ; Make es equal to cs
mov   bx,[si] ; Assign VMT pointer to bx
call  es:[bx] ; Indirectly call subroutine using VMT entry

```

The code assumes that `ds:si` address the object instance and that the instance's VMT pointer is the first item in the instance structure. The first two lines initialize `es` to the address of the code segment—assuming that you store VMTs in that segment. If you store them elsewhere—in the data segment, for example—initialize `es` accordingly.

The third line moves the 16-bit VMT pointer from the object instance into `bx`. The final instruction indirectly calls the first method at the address in the VMT. To call the second virtual method, add `02` to `bx`. To call the third method, add `04`, and so on. For example:

```

call  es:[bx+02] ; Call second virtual method (small model)
call  es:[bx+04] ; Call third virtual method (small model)

```

In small memory-model programs, VMT pointers are 16-bit offsets, but you must address VMTs using the `es` and `bx` registers (a full 32-bit pointer). Entries in the VMT are 16-bit offsets, and all code is assumed to be in the program's code segment.

In large and huge memory model programs, VMT pointers are 32-bit addresses, as are VMT entries. Calling virtual methods therefore requires a little more effort. For example, you can use code like this:

```

mov   bx, 1F62      ; Move VMT segment into bx
mov   es, bx        ; Set es to VMT segment
les   bx, [si]      ; Load es:bx with VMT pointer from instance
call  es:far [bx]   ; Indirectly call first virtual method in VMT

```

The first two lines initialize `es` to the segment where VMTs are stored. The actual address value, `1F62`, will be different in your programs (and is best replaced with the segment name). The third line uses the `les` instruction to load `es:bx` with the 32-bit pointer in the object instance addressed by `ds:si`. The `call` instruction on the final line calls the subroutine at the address in the VMT's first entry. Because those entries are full 32-bit addresses, you must add `04` rather than `02` to access other virtual methods. For example, to call the second virtual method in an object, use the instruction:

```

call  es:far [bx+04] ; Call second virtual method (large and huge models)

```

All of the preceding examples assume that VMT pointers are the first data elements of object instances. It is possible to design instances that store VMT pointers elsewhere (or that use multiple VMT pointers), but these techniques require careful programming and debugging. In these cases, instead of `CALL...METHOD`, use the code fragments in this section as guides for calling virtual methods.

Optimized Tail Recursion

A variation of the `CALL...METHOD` directive can optimize some kinds of methods (virtual or static). When a method ends with a `CALL...METHOD` instruction, you can often gain a tiny bit of speed by using a well-known optimization technique called *optimized tail recursion*.

This technique isn't limited to object-oriented programming. In general, when any subroutine ends with a `call` instruction followed by a `return`, that `call` can be replaced with a `jmp`. For example, consider what happens in a subroutine that ends with the two instructions:

```
call OtherSubroutine
ret
```

When `OtherSubroutine` returns via its own `ret` instruction, the program simply executes another `ret`. The two returns are obviously redundant, and the preceding two instructions can be replaced with:

```
jmp OtherSubroutine
```

This chops the tail off the subroutine, causing it to jump to `OtherSubroutine`, which returns to the original caller. In the balance, you have gained stack space and reduced two `ret` instructions to one. This is why the technique is called optimized tail recursion. (Like many technical terms, the process sounds more exotic than it really is.)

Object-oriented programs can use Turbo Assembler's `JMP...METHOD` directive to perform a similar optimization for some kinds of methods. The first step is to identify any methods that end with a `CALL...METHOD` instruction, or that can be modified to do so. For example, change to the `OOP\INHERIT` directory and load the `TDERIVED.INC` file into your editor (or refer back to Listing 14.4).

The `TDerived_getData` method near the end of the file begins with a `CALL...METHOD` instruction. Because the order of the method's instructions is not critical in this subroutine, the `CALL...METHOD` directive can be moved to just above `ret`. If you want to follow along, revise the method to look like this:

```
PROC TDerived_getData PASCAL
    mov dx, [(TDerived PTR si).TDerived_data]
    CALL si METHOD TBase:getData ; Move this line to here
    ret
ENDP TDerived_getData
```

In your own code, always assemble, link, and test the program at this stage to be sure the modified method works correctly. If all is well, you may replace the method's final two instructions with `JMP...METHOD`. Simply change `CALL` to `JMP` and delete `ret`. The optimized method is now:

```
PROC TDerived_getData PASCAL
    mov dx, [(TDerived PTR si).TDerived_data]
    JMP si METHOD TBase:getData
ENDP TDerived_getData
```

Summary

Object-oriented programming, or OOP, uses objects to encapsulate data and code. Turbo Assembler's OOP features make it possible to write object-oriented programs in assembly language.

Advantages of OOP include potentially easier debugging, maintenance, and revisions—especially in large programs. Disadvantages include the increased initial difficulty of designing an object-oriented program and the fact that few if any standards exist for object structures.

Three key techniques characterize OOP: encapsulation, inheritance, and virtual methods. In Turbo Assembler, you encapsulate data and code in special `STRUC` declarations, called *objects*. An object (called the derived object) may inherit the code and data members of another object (called the base object). The object's subroutines, or *methods*, may be static (called directly) or virtual (called by looking up the subroutine addresses from a virtual method table (VMT)).

All objects that have one or more virtual methods must define a VMT pointer (or inherit the pointer from a base object). All such objects must also define a VMT. Objects inherit VMT pointers, but not VMTs. The VMT pointer in each object instance must be initialized to point to the object's VMT.

Use the `CALL . . . METHOD` directive to call object methods and to pass arguments to them. You may replace `CALL . . . METHOD` in some cases with `JMP . . . METHOD` to optimize methods that end with calls to other methods.

Polymorphism is the process of creating objects that use virtual methods to select actions at runtime. The `TList` and `TItem` objects in this chapter demonstrate how to use polymorphism to create lists of different kinds of object instances.

Exercises

- 14.1. Add `CALL . . . METHOD` statements to `ENCAPSUL.ASM` (Listing 14.2) to set both of object `p2`'s data members to zero.
- 14.2. Declare a new object, `TRect`, that defines the upper left and lower right coordinates of an imaginary rectangle. Think of this object as a means for designating rectangular regions on a text or graphics display. Include some methods that you think the object will need.
- 14.3. Design a method that receives two word arguments. Insert statements in the method that load the arguments into registers `cx` and `dx`. The method should preserve the registers it uses. (The result of this exercise makes a useful shell for beginning new methods.)
- 14.4. Show the steps required to call an imaginary static method, `AnyStatic`, declared by an object, `TAnyObject`.

- 14.5. Show the steps required to call an imaginary virtual method, `AnyVirtual`, declared by an object, `TAnyObject`.
- 14.6. *Advanced.* Create a new object, `TDateObj`, derived from this chapter's `TItem` object (Listing 14.10). Your object should have data members that can store the date (year, month, and day). (*Hint:* `TItem` declares a virtual method. Be sure to include all necessary virtual-method components in `TDateObj`.)
- 14.7. *Advanced.* Using your `TDateObj` object from exercise 14.6, modify `LIST.ASM` (Listing 14.14) to store and display two `TDateObj` instances on the program's list.

Projects

- 14.1. Modify `TList` to be derived from `TItem` so that `TList` instances can themselves be stored on lists. Write a demonstration program that shows how a program can create a list of lists, which could contain lists of other lists, and so forth—in other words, multidimensional arrays.
- 14.2. *Advanced.* Expand `TList` to include other methods for searching, inserting, deleting, and rearranging `TItem` instances from lists. What kinds of methods do you think your programs will need? Should you implement those methods now, or should you wait until you have a use for them? (These are important questions to ponder in object-oriented programming, but there are no correct answers. I pose them because you should consider these issues in your own programming.)
- 14.3. Convert one or more object-oriented programs from a C++ or Pascal tutorial to assembly language. Keep a log of the difficulties you encounter.
- 14.4. Convert the object-oriented list demonstration and its associated modules in this chapter to C++ or Pascal.
- 14.5. *Advanced.* Reassemble the `MTA.LIB` library for the large and huge memory models, and revise the list demonstration (Listing 14.14) in this chapter to use the large model. Create small, large, and huge memory-model library files, and invent a system for linking to the correct library.
- 14.6. *Advanced.* Write a utility program that displays the address values in a virtual method table.

15

CHAPTER

Programming for Windows

- Introducing Windows Programming with TASM, 654
- Developing Windows Applications with TASM, 679
- Summary, 698
- Exercises, 699
- Projects, 700

Introducing Windows Programming with TASM

Although most Windows developers write their programs in C, you can also use Turbo Assembler to write software for this popular operating system. With assembly language, you gain full control over an application's startup and shutdown instructions, and you can efficiently use registers and perform other optimizations not available to high-level-language programmers.

But writing Windows programs in assembly language isn't easy. There's little information available on the subject, and what has been published is of poor quality. For example, Borland's own documentation on TASM and Windows is sparse and contains numerous errors. Worse, the sample Windows programs on TASM's disks are incomplete or have serious bugs that can crash Windows and cause a loss of information. (*Do not base your own code on TASM's examples!*)

To help correct these oversights, this chapter introduces Windows programming with TASM in Ideal mode. In the following sections, you'll find line-by-line descriptions of two complete Windows applications, which demonstrate the following key Windows programming techniques in assembly language:

- How to write a startup module
- How to initialize a Windows application
- How to call Windows functions
- How to register window classes
- How to create and display a window
- How to write a message loop
- How to receive, respond to, and send messages
- How to design and use a dialog box
- How to design and use popup menu commands
- How to paint graphics in a window

Although there's a lot of information in this chapter, it is not a complete tutorial to Windows programming. I'll introduce as much of the subject as one chapter allows, but to write finished Windows applications in assembly language, you'll also need a tutorial such as Charles Petzold's *Programming Windows 3.1*, or one of my own books, *Mastering Windows Programming with Borland C++* or *Type and Learn Windows Programming Using WinScope*. In addition, to go beyond the information in this chapter, you will also need a Windows API (application programming interface) reference plus other utilities and files supplied with a Windows development system.

NOTE:

Turbo Assembler does not provide all necessary tools and files required to assemble and link Windows code files. In addition to the files you receive with Turbo Assembler, you also need utilities such as resource and help-system compilers, an import library (for linking programs to Windows functions), and Turbo Debugger for Windows (TDW). The programs in this chapter require Turbo Assembler 4.0 (usually installed in the directory C:\TASM), and also Borland C++ 4.0, 4.5, or a later version (usually installed in the directory C:\BC4 or C:\BC45). In addition, the directory C:\BC4\BIN must be on the system path in order to link the example programs in this chapter. On disk, this chapter's programs are provided in source and executable forms so you can study and run the examples even if you don't have Borland C++.

Minimum Windows Application

Always keep in mind one fact about Window applications—they are simply DOS programs that run under control of the Windows operating system. Unlike common DOS applications, however, Windows programs must obey many new rules and regulations, which makes it tough to master the necessary techniques.

Listing 15.1, WHELLO.ASM, demonstrates the basic requirements of Windows assembly language programs. Assembling and linking the program requires two additional files in Listings 15.2 (WHELLO.DEF) and 15.3 (WHELLO.RC). I'll explain the purpose of each of these files after the listings. Unless I mention otherwise, line number references are to WHELLO.ASM.

Listing 15.1. WHELLO.ASM

```
1: %TITLE "Bare Windows program in assembly language -- by Tom Swan"
2:
3:     IDEAL
4:
5:     JUMPS
6:
7:     P286
8:
9:     LOCALS @@
10:
11:     MODEL large, WINDOWS PASCAL
12:
13: ;----- Include Windows declarations (MASM mode required)
14:
15:     %NOINCL
16:
```

continues

Listing 15.1. continued

```

17:          MASM
18:
19:          INCLUDE windows.inc
20:
21:          IDEAL
22:
23: ;----- Define external functions imported from Windows
24:
25: EXTRN    InitTask:PROC
26: EXTRN    WaitEvent:PROC
27: EXTRN    InitApp:PROC
28: EXTRN    LoadIcon:PROC
29: EXTRN    LoadCursor:PROC
30: EXTRN    CreateWindow:PROC
31: EXTRN    ShowWindow:PROC
32: EXTRN    UpdateWindow:PROC
33: EXTRN    RegisterClass:PROC
34: EXTRN    GetMessage:PROC
35: EXTRN    TranslateMessage:PROC
36: EXTRN    DispatchMessage:PROC
37: EXTRN    PostQuitMessage:PROC
38: EXTRN    DefWindowProc:PROC
39:
40: ;----- Define global program procedures called internally
41:
42: GLOBAL  PASCAL  WinMain:PROC
43: GLOBAL  PASCAL  AppInit:PROC
44: GLOBAL  PASCAL  AppRun:PROC
45: GLOBAL  PASCAL  RegisterWin:PROC
46:
47: ;----- Define program procedures exported to Windows
48:
49: PUBLIC  WndProc
50:
51: ;----- Define resource equates
52:
53: ID_ICON          EQU    100
54:
55: ;----- Global initialized variables
56:
57:          DATASEG
58:
59: ;----- The following 16-byte buffer must be first in the program's
60: ;          data segment. Windows uses this area for its own purposes.
61:
62:          DB      16 DUP (0)          ; Reserved for Windows
63: exCode        DB      0              ; Exit code returned to DOS
64: szAppName     DB      'WHello', 0   ; App name or window title
65: szWndName     DB      'WHelloWin', 0 ; Window class name
66:
67: ;----- Global uninitialized variables
68:
69:          UDATASEG
70:

```

```

71: psp          DW      ?          ; Program segment prefix
72: pszCmdLine   DW      ?          ; Pointer to command line string
73: hPrevInst    DW      ?          ; Handle to previous instance
74: hInstance    DW      ?          ; Handle to this instance
75: cmdShow      DW      ?          ; Window display style
76: msg          MSGSTRUCT ?       ; Message loop structure
77:
78:             CODESEG
79: Start:
80:
81: ;----- Begin required initializations
82:
83:     call      InitTask           ; Initialize this task
84:     or        ax, ax             ; Test result in ax
85:     jnz      @@InitTaskOk       ; Continue if ax is not zero
86:     jmp      @@InitFail         ; Else exit with error code
87:
88: @@InitTaskOk:
89:
90: ;----- Save various items returned by InitTask
91:
92:     mov      [psp], es           ; Program segment prefix
93:     mov      [pszCmdLine], bx    ; Pointer to command line (es:bx)
94:     mov      [hPrevInst], si     ; Previous program instance handle
95:     mov      [hInstance], di    ; This program instance handle
96:     mov      [cmdShow], dx       ; Window display style
97:
98: ;----- Continue required initializations
99:
100:    push     0                   ; Push task ID (0 = current task)
101:    call    WaitEvent           ; Clear any waiting events
102:    push    di                   ; Push program instance handle
103:    call    InitApp             ; Initialize application queue
104:    or     ax, ax               ; Test result in ax
105:    jnz    @@InitAppOk         ; Continue if InitApp successful
106:    jmp    @@InitFail          ; Else exit with error code
107:
108: @@InitAppOk:
109:
110:    call    WinMain             ; Inits done--start application
111:    jmp    Exit                 ; Jump to exit
112:
113: @@InitFail:
114:
115:    mov     [exCode], 0ffh      ; Startup error code = -1
116:
117: Exit:
118:    mov     ah, 04Ch            ; DOS function: Exit program
119:    mov     al, [exCode]        ; Return exit code value
120:    int     21h                 ; Call DOS. Terminate program
121:

```

continues

Listing 15.1. continued

```

122: ;-----
123: ; WinMain                      Equivalent to WinMain in a C program
124: ;-----
125: ; Input:
126: ;   none
127: ;   Note:   This procedure isn't required, but it permits Turbo
128: ;           Debugger to skip over the startup code and begin
129: ;           tracing here. Apparently, this happens because TD
130: ;           recognizes WinMain as the application entry point.
131: ; Output:
132: ;   none
133: ; Registers:
134: ;   none
135: ;-----
136: PROC    WinMain PASCAL
137:         call    AppInit          ; Initialize application
138:         call    AppRun          ; Execute message loop
139:         ret
140: ENDP    WinMain
141:
142: ;-----
143: ; AppInit                      Register and create the app's window
144: ;-----
145: ; Input:
146: ;   hPrevInst  Handle to previous instance (global)
147: ;   hInstance  Handle to this instance (global)
148: ;   cmdShow    Window display style (global)
149: ; Output:
150: ;   none
151: ; Registers:
152: ;   ax
153: ;-----
154: PROC    AppInit PASCAL
155:         USES    di, si
156:
157:         call    RegisterWin      ; Register program's main window
158:         mov     si, [hInstance]  ; Use si to hold instance handle
159:
160: ;----- Create element of window from registered window class
161:
162:         push    ds                ; Segment for szWndName
163:         push    OFFSET szWndName  ; The window's class name
164:         push    ds                ; Segment for szAppName
165:         push    OFFSET szAppName  ; Caption for title bar
166:         push    WS_OVERLAPPEDWINDOW ; The window's style
167:         push    0                 ; Low word of Style
168:         push    CW_USEDEFAULT     ; Starting x coordinate
169:         push    CW_USEDEFAULT     ; Starting y coordinate
170:         push    CW_USEDEFAULT     ; Starting width
171:         push    CW_USEDEFAULT     ; Starting height
172:         push    0                 ; Handle to parent window (none)
173:         push    0                 ; Handle to menu (none)
174:         push    si                ; Program instance handle
175:         push    0                 ; Optional user parameters (none)
176:         push    0                 ; Optional user parameters (none)
177:         call    CreateWindow      ; Create window element
178:         mov     di, ax            ; Save window handle in di

```

```

179:
180: ;----- Begin process of showing main window
181:
182:     push    di                ; Push window handle
183:     push    [cmdShow]         ; Push window style
184:     call    ShowWindow        ; Make window visible
185:
186: ;----- Force immediate painting of window contents
187:
188:     push    di                ; Push window handle
189:     call    UpdateWindow      ; Update window contents
190:
191:     ret
192: ENDP   AppInit
193:
194: ;-----
195: ; AppRun                Run the application (the "message loop")
196: ;-----
197: ; Input:
198: ; none
199: ; Output:
200: ; none
201: ; Registers:
202: ; ax
203: ;-----
204: PROC   AppRun   PASCAL
205: @@10:
206:     push    ds                ; Push msg segment address
207:     push    OFFSET msg        ; Push msg offset address
208:     push    NULL              ; Unused
209:     push    NULL              ; Unused
210:     push    NULL              ; Unused
211:     call    GetMessage        ; Get next message
212:     or     ax, ax             ; Did GetMessage return zero?
213:     jz     @@99              ; If yes, exit loop
214:     push    ds                ; Push msg segment address
215:     push    OFFSET msg        ; Push msg offset address
216:     call    TranslateMessage   ; Translate keyboard messages
217:     push    ds                ; Push msg segment address
218:     push    OFFSET msg        ; Push msg offset address
219:     call    DispatchMessage   ; Send message to window proc
220:     jmp    @@10              ; Loop until app ends
221: @@99:
222:     ret
223: ENDP   AppRun
224:
225: ;-----
226: ; RegisterWin          Register the program's main window class
227: ;-----
228: ; Input:
229: ; hPrevInst   Handle to previous instance (global)
230: ; hInstance   Handle to this instance (global)
231: ; Output:
232: ; none
233: ; Registers:
234: ; ax
235: ;-----

```

Listing 15.1. continued

```

236: PROC   RegisterWin  PASCAL
237:       LOCAL  @@wc:WNDCLASS          ; Allocate structure on stack
238:       USES   di, si                 ; Preserve registers
239:
240:       cmp    [hPrevInst], 0         ; Is a prior instance running?
241:       jne    @@99                   ; If yes, jump to exit
242:       mov    si, [hInstance]        ; Use si to hold instance handle
243:
244: ;----- Assign values to global window class structure @@wc
245:
246:       mov    [@@wc.clsStyle], NULL
247:       mov    [WORD PTR @@wc.clsLpfnWndProc      ], OFFSET WndProc
248:       mov    [WORD PTR (@@wc.clsLpfnWndProc) + 2], SEG WndProc
249:       mov    [@@wc.clsCbClsExtra], 0
250:       mov    [@@wc.clsCbWndExtra], 0
251:       mov    [@@wc.clsHInstance], si
252:
253: ;----- Get and assign icon handle from app's resources
254:
255:       push   si                      ; Program instance handle
256:       push   0                       ; High word of resource ID
257:       push   ID_ICON                 ; Low word of resource ID
258:       call  LoadIcon                ; Load icon from app's resources
259:       mov   [@@wc.clsHIcon], ax      ; Save resulting icon handle
260:
261: ;----- Get and assign a cursor handle
262:
263:       push   0                       ; Instance handle (none)
264:       push   0                       ; High word of resource ID
265:       push   IDC_ARROW               ; Low word of resource ID
266:       call  LoadCursor              ; Load standard cursor
267:       mov   [@@wc.clsHCursor], ax    ; Save resulting cursor handle
268:
269: ;----- Assign remaining window class structure values
270:
271:       mov    [@@wc.clsHbrBackground], COLOR_WINDOW + 1
272:       mov    [WORD PTR @@wc.clsLpszMenuName      ], NULL
273:       mov    [WORD PTR (@@wc.clsLpszMenuName) + 2], NULL
274:       mov    [WORD PTR @@wc.clsLpszClassName    ], OFFSET szWndName
275:       mov    [WORD PTR (@@wc.clsLpszClassName) + 2], ds
276:
277: ;----- Register the window class
278:
279:       push   ss                      ; Push segment of wc
280:       lea   ax, [@@wc]               ; Load ax with wc offset
281:       push   ax                      ; Push offset of wc
282:       call  RegisterClass            ; Register the window class
283: @@99:
284:       ret
285: ENDP   RegisterWin
286:

```

```

287: ;-----
288: ; WndProc          Main Window Procedure (called by Windows)
289: ;-----
290: ; Input:
291: ;   hWnd          WORD (stack)   Handle to window
292: ;   uMsg          WORD (stack)   Message identifier
293: ;   wp            WORD (stack)   Optional word parameter
294: ;   lp            DWORD (stack)  Optional double word parameter
295: ; Output:
296: ;   Depends on message
297: ; Registers:
298: ;   ax, dx
299: ;-----
300: PROC    WndProc WINDOWS PASCAL FAR
301:     ARG    hWnd:WORD, uMsg:WORD, wp:WORD, lp:DWORD
302:     USES   si
303:
304:     mov    si, [uMsg]                ; Use si to hold message
305:     cmp    si, WM_DESTROY           ; Is message WM_DESTROY?
306:     je     @WMDESTROY              ; If yes, jump to process message
307:     jmp    @DEFWINDOWPROC          ; Else jump to default processor
308:
309: @WMDESTROY:
310:     push   0                        ; Push user-defined exit code
311:     call  PostQuitMessage          ; Call Windows to post WM_QUIT msg
312:     xor    dx, dx                  ; Return 0L (DWORD zero) in ax:dx
313:     xor    ax, ax
314:     jmp    @@99
315:
316: @DEFWINDOWPROC:
317:     push   [hWnd]                  ; Push window handle
318:     push   si                      ; Push message value
319:     push   [wp]                    ; Push optional word parameter
320:     push   [lp]                    ; Push optional long parameter
321:     call  DefWindowProc            ; Call default message handler
322: @99:
323:     ret
324: ENDP    WndProc
325:
326:     END    Start                ; End of program / entry point

```

Listing 15.2. WHELLO.DEF.

```

1: NAME           WHELLO
2: DESCRIPTION    'WHello v1.00a (C) 1995 by Tom Swan'
3: EXETYPE        WINDOWS
4: STUB           'WINSTUB.EXE'
5: CODE           PRELOAD MOVEABLE DISCARDABLE
6: DATA          PRELOAD MOVEABLE MULTIPLE
7: HEAPSIZE       1024
8: STACKSIZE      8192
9: EXPORTS        WndProc

```

Listing 15.3. WHELLO.RC.

```
1: #define ID_ICON 100
2:
3: ID_ICON ICON whello.ico
```

How to Assemble WHello

Use MAKEFILE on the book's disk to assemble and link the WHello demonstration program. If you receive any error messages, modify the pathnames in this file. You must have Turbo Assembler 4.0 and Borland C++ 4.0, 4.5, or later versions installed on your hard drive. C:\TASM\BIN and C:\BC4\BIN, or the equivalent directories, must be on the system PATH.

There are many ways to assemble and link WHello. Change to the WIN\WHELLO subdirectory, and then type one of the following commands:

```
make
make -DDEBUG
make -DLISTING
make -DDEBUG -DLISTING
```

The first command assembles and links the program. The second command does the same but also adds debugging information to the final code file so you can run it with TDW. The third command generates a program listing file, WHELLO.LST. The fourth command assembles and links the program, and also adds debugging information and generates a listing file.

Add option **-B** to any of those commands to rebuild the entire program from scratch. You might do that, for example, after you make a change to a module and you want to reassemble with debugging information.

For easier assembly, on disk you'll find two batch files. Type **build** to run BUILD.BAT, which assembles and links all program modules. Type **mak** (with no trailing e) to run MAK.BAT, which assembles and links any modified program modules. Both batch files add debugging information and generate a listing file.

After assembling and linking the program, open the Windows File Manager and change to the WIN\WHELLO directory. Select WHELLO.EXE to run the program, which displays the Window in Figure 15.1. Try moving the window around, expand it to full screen, and perform other common operations. As these tests suggest, though simple, WHello is a complete Windows application. Use your normal method to end the program—for example, press Alt+F4, double-click the button at upper left, or click that button to open the system menu and select the *Close* command.

Figure 15.1.
WHello's simple display.

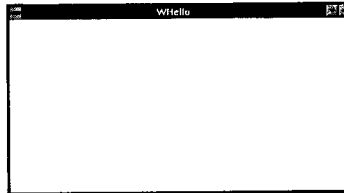

The Preface

There are several preparatory steps you must perform before you can write the first instruction in a Windows program. Lines 3-11 in `WHELLO.ASM` (Listing 15.1) select Turbo Assembler's Ideal mode, enable jump optimizations, specify 80286 instructions (Windows 3.1 requires an 80286 or later model processor), and engage local symbols prefaced with `@`. Line 11 is the most important in the set. It selects the large memory model, and also specifies the `WINDOWS` and `PASCAL` options.

You may use other memory models, but the large model is probably best for assembly language. Windows functions must be called using `far`, 32-bit addresses, and there's little to be gained by writing small memory-model code. (It might be advantageous, however, to call local subroutines using 16-bit offset addresses. In that case, you can use the small memory model.)

You must specify `WINDOWS` and `PASCAL` in a `MODEL` directive so that Turbo Assembler adds the necessary prolog and epilog instructions to subroutines. These options alter the instructions generated for the `PROC` and `ENDP` directives, which you should use to begin and end subroutines.

NOTE:

Advanced programmers can use different calling conventions for internal subroutines—it is not necessary to add Windows prolog instructions to every procedure. In that case, however, be sure to specify `WINDOWS`, `PASCAL`, and `FAR` in your program's callback functions as shown in `WINHELLO.ASM` at line 300. (A callback function is a subroutine that Windows calls—but more on that later.)

Lines 15-21 include the file `WINDOWS.INC`, usually found in `C:\TASM\INCLUDE`. If you have Borland C++, you'll find an identical copy of this file in `C:\BC4\INCLUDE`. The same file is also supplied with the Microsoft Windows Software Development Kit (SDK). In this file are various structure and symbol declarations—assembly language equivalents to the declarations in the `WINDOWS.H` header file for C programs. The file's declarations are in

MASM mode, so you must switch to that mode (line 17) before including the file. Because of this switch, you must not use quote marks around the file name (line 19). Line 21 switches back to Ideal mode for the rest of the module. Line 15 prevents writing WINDOWS.INC to the program's listing file.

NOTE:

Do not use the `STACK` directive in a Windows application. Windows allocates space for your program's stack according to the value specified in a linker definition file (WHELLO.DEF in this example).

External and Public Declarations

A Windows program consists largely of calls to the Windows API, which contains hundreds of functions. Before you can call a Windows function, you must declare it external (`EXTRN`) to your program as demonstrated at lines 25-38. Simply add new functions to this list using the style shown:

```
EXTRN ShowWindow:PROC
```

If you did not specify the large memory model and the `PASCAL` option in a `MODEL` directive, use the full form instead:

```
EXTRN PASCAL ShowWindow:FAR
```

Lines 42-45 declare the program's own subroutines `GLOBAL`, and also select the `PASCAL` calling convention for them. You may use a different calling convention for local subroutines, but `PASCAL` permits easy passing of arguments on the stack. The four `GLOBAL` directives are not required—they simply declare the subroutines so statements can call them from any location. In a large program with many modules, you might want to store `GLOBAL` directives in a separate file and include it in other modules.

Line 49 declares a different kind of subroutine, known as a *callback function*. You never call a callback function. Instead, you pass the callback subroutine's address to Windows, which calls it *back* at the appropriate times. In this case, `WHello` has only one callback function—`WndProc`, which must be declared `PUBLIC` (line 49). You must write callback functions in the proper form as demonstrated later in the listing.

Line 53 declares the symbol `ID_ICON`, equated to the value 100. The symbol identifies a *resource*, which in this example is the program's system icon that Windows displays when you minimize the program's window.

Data Segments

Windows programs may define initialized and uninitialized data. Initialized data is stored in the program's .EXE code file, and is loaded into memory at runtime. Uninitialized data is allocated memory bytes at runtime that have no predetermined values.

Use the `DATASEG` directive to create space for your program's initialized data. You *must* use this directive, even if your code has no global variables, and you must reserve the first 16 bytes of the data segment for Windows' private use (lines 57-62).

Following these required 16 bytes, define any global variables that your program uses. In this case, `WHello` has three initialized variables: `exCode` holds a value returned to DOS when the program terminates; `szAppName` represents the application name (also displayed as the main window's title); `szWndName` represents the name of the *window class*, which describes a window's characteristics. Window classes must have unique names throughout an application—usually, their names are formed by adding “Win” to the module name as I did at line 65, but you may use another name if you prefer.

NOTE:

The `sz` preface in `szAppName` and `szWndName` stands for “zero-terminated string.” You'll see many similar memory-jogging prefaces in Windows symbols. For example, `lpfn` stands for “long pointer to a function,” `wp` means “word parameter,” `lp` means “long parameter,” and so on. A typical Windows application contains thousands of symbols, and these naming conventions help keep programs readable, and therefore, easier to modify and maintain.

In addition to initialized data, a Windows program may allocate memory for variables that will be assigned values at runtime. Precede all such declarations with a `UDATASEG` directive as shown at line 69.

Lines 71-76 declare `WHello`'s uninitialized data. The sample program doesn't use the first two variables, which hold the program segment prefix (that is, the segment address where DOS expects to find various items related to this program), and the offset address of the command-line string if one was passed to the program. These values might be useful in more advanced applications.

Lines 73-75 are required in all Windows programs. The `hPrevInst` and `hInstance` variables are *program instance handles*. As you learn more about Windows programming, you'll frequently run across the word *handle*. A handle is simply an integer value that represents an internal object of some kind. A program instance handle, for example, uniquely identifies the task which is the executing code of an application. A window handle represents a window's data structure maintained by Windows. You pass handles to various functions—to display a specific window, for example, or to draw graphics inside its borders.

The `hPrevInst` handle at line 73 refers to a previous program instance if you have run more than one copy of `WHello`. The `hInstance` handle at line 74 refers to the current program instance. Try running more than one copy of `WHello` now. Each instance shares the same code in memory, but receives its own data segment. You may run as many program instances as memory allows. (Some applications, however, prevent you from executing them more than once.)

The `cmdShow` variable at line 75 represents the main window's style. Usually, this value is set to 1 to indicate that the window should be displayed normally. But it can be any one of the following values, declared in `WINDOWS.INC`:

```
SW_SHOWNORMAL      = 1
SW_SHOWMINIMIZED   = 2
SW_SHOWMAXIMIZED   = 3
```

Line 76 in the sample program's uninitialized data segment defines a message structure of the type `MSGSTRUCT`, declared in `WINDOWS.INC`. Windows uses many structures to describe various items. In this case, `msg` represents a *message*, which is obtained and processed by the program's message loop—but more on that and related subjects later.

NOTE:

You may repeat the `DATASEG` and `UDATASEG` directives as many times as needed. You don't have to define all variables in one place, or even in one module. Be sure, however, to reserve the first 16 bytes in the initialized data segment for Windows' private use.

Startup Code

C programmers know that function `WinMain` is where Windows programs begin executing. But that's true only for the program's C statements. Before `WinMain` comes critical low-level code that all Windows programs must execute.

Most Windows development systems provide this critical code in a *startup module*. If you have Borland C++, for example, you'll find the Windows startup module in file `C0W.ASM` located in the `C:\BC4\LIB\STARTUP` directory. Other development systems such as Borland Pascal for Windows automatically add startup code to compiled programs. Typically, the startup module calls a few Windows functions, initializes some required variables, and calls `WinMain`.

In assembly language, you must provide all startup instructions, as demonstrated at lines 78-120 in `WHELLO.ASM` (refer to Listing 15.1). Despite its name, the startup code is also responsible for terminating a Windows application. You must correctly program all startups—any mistakes here will surely cause serious problems. One advantage to writing your own

startup code, however, is the elimination of excess baggage. Borland's C++ startup module, for instance, prepares various tables, calls static class-object constructors, and performs other initializations required by standard-library functions that are of no value to assembly language programmers.

The first step should be a call to `InitTask`, a Windows API function declared `EXTRN` at line 25. The function requires no arguments, so as line 83 demonstrates, you simply call it.

Line 84 tests the result of `InitTask` returned in register `ax`. If this value is not zero, line 85 continues the program by jumping to the label at line 88. If `InitTask` returned zero, Windows could not initialize the task (usually because of a lack of memory). In that event, line 86 jumps to label `InitFail`.

NOTE:

Most documentation on Windows is in C, and therefore, you may need to know C to write assembly language code for specific operations. For example, you must pass all required arguments to Windows functions on the stack, and you must refer to values returned in various registers, but the official documents explain these steps only for C. *Hint:* Use the Borland C++ `-s` option to compile sample C programs into the equivalent `.ASM` assembly language text. You can then examine the generated text for guidelines.

In general, Windows functions return 16-bit values in register `ax`. They return 32-bit values in `ax:dx`. If those values represent an address, the segment portion is in `dx`; the offset is in `ax`. With few exceptions (`InitTask`, for instance) Windows functions preserve registers `di`, `si`, `bp`, and `ds`. If you use other registers to store variables, push them onto the stack before calling a Windows function, then pop them off the stack after the call.

Returning to the sample program (refer back to Listing 15.1), lines 92-96 save the values returned by `InitTask`. Among them are the program's instance handles and main-window style.

Lines 100-106 continue the initialization process. First, lines 100-101 call `WaitEvent`, which clears any waiting *events* for a given task. Line 100 pushes the required argument, equal to the task's ID (zero represents the current task). There is always one such event—the one that started this task. The call at line 101 clears this event, and also checks the Windows scheduler to check for any other tasks that might be scheduled for execution.

Lines 102-103 perform the third and final required initialization—calling the `InitApp` function, which initializes the application's message queue, a small amount of memory that holds the application's messages. Register `ax` indicates whether `InitApp` was successful. If `ax` is zero, the program must end immediately because it has no message queue. Otherwise, line 110 calls `WinMain`, where the application's action begins.

Lines 100-103 also demonstrate an intriguing aspect of programming Windows in assembly language. If you examine disassembled high-level-language applications (as I did when researching this chapter), you may find instructions such as these in the startup code:

```
xor ax, ax
push ax
call WaitEvent
mov ax, [hInstance]
push ax
call InitApp
```

That fragment is logically equivalent to the instructions in WHELLO.ASM at lines 100-103. However, instead of zeroing `ax` and then pushing it onto the stack, it is simpler to push a literal zero value. Also, because `di` holds the program's instance handle returned by the preceding call to `InitTask`, line 102 pushes that value rather than reloading it from the `hInstance` global variable.

In this case, these small optimizations have a tiny, and probably imperceptible, effect on the program's speed. But other small improvements can go a long way. In assembly language, *you* decide how to use registers and memory. In C, Pascal, and other languages, the compiler makes many of these decisions for you.

The startup code is also responsible for terminating a Windows program, which is the same as ending a DOS program. Lines 118-120 terminate the `WHello` program after its `WinMain` function returns. Line 115 stores `-1` in the global `exCode` variable, which normally equals `0` if no errors were detected. The instructions at lines 118-120 copy this value into `ax` along with the DOS function code `04Ch`, and then execute interrupt `21h` to return to Windows. The Windows operating system takes over this and other interrupts from DOS, so even though line 120 appears to return to DOS, it actually passes control back to Windows.

Initializing the Data Segment Register

Each instance of a program—in other words, each new copy of the program that you execute—receives its own data segment from Windows. You must allow Windows to provide the data segment address and to initialize register `ds`. This happens when Windows loads the application, thus `ds` is already initialized before the program executes its first instruction.

Never set `ds` to `@data` as you do for DOS programs—and as Borland's example programs on TASM's disks incorrectly show. *Do not begin your program's startup code with these instructions:*

```
mov ax, @data ; How to destroy a Windows application
mov ds, ax    ; in two easy steps!
```

This very bad error causes all program instances to refer to the same data segment. When one of those instances ends, the others' data references are to unprotected memory. Such references can lead to GPFs (general protection faults) and can cause DOS and Windows to

become unstable. Worse, your system's memory manager may cancel Windows altogether and return you to a DOS prompt, which may cause a permanent loss of any unsaved documents.

WARNING:

Initializing `ds` may be harmful to your program's health. Always allow Windows to assign a value to `ds`.

The WinMain Function

As I mentioned, Line 110 in Listing 15.1, `WHELLO.ASM`, calls subroutine `WinMain`. This step isn't required—the subroutine simply calls two others (see lines 136-140), so `WinMain`'s effect is nil. You may remove `WinMain` by replacing line 110 with the two instructions:

```
call AppInit
call AppRun
```

The only reason for including `WinMain` is to fool Turbo Debugger for Windows into treating the code as though it were a C program. Apparently, TDW recognizes `WinMain` as a Windows application's startup location.

When you start TDW, select *File/Open* and enable the *Execute startup code* check box to begin tracing the program at the first statement in `WinMain`. Disable this check box to begin tracing at the program's startup instructions (at the call to `InitTask` in `WHello`). Except to enable this trick, `WinMain` has no practical purpose in an assembly language program.

Window Registration

Aside from its startup and shutdown code, a Windows application can be broadly divided into two stages. Stage one *registers* a window class, and creates an instance of that class to serve as the program's main window. Stage two executes the program's *message loop*, which receives messages intended for the program and passes them along to their final destination.

NOTE:

A message loop is needed because Windows employs a system of *non-preemptive multitasking*. This means that each program instance is responsible for providing the opportunity for other programs to run. A preemptive multitasking operating system is itself responsible for allocating time to running tasks (time sharing). If a Windows program executes lengthy sequences of instructions without eventually returning to the message loop, other programs will be prevented from running normally.

I'll cover stage two in a later section. Stage one is further divided into two operations: window class registration and window creation. In `WHello`, when `WinMain` calls `AppInit`, line 157 immediately calls `RegisterWin`, a subroutine at lines 236-285. This subroutine registers the program's main-window class.

A *window class* is a description of a window's characteristics—its border style, color, icon, cursor shape, and so on. In addition to these data elements, a window class specifies the address of a subroutine—called a *window procedure*—that is responsible for handling messages sent to the window.

You must register a window class before you can create instances (also called elements) of that class. You may create as many elements of a window class as your program needs. The same class is used by multiple program instances; therefore, only the first instance should register the class. Subsequent instances should use that same registered class to create their main window elements.

Before registering a window class, always check whether there are any prior program instances. Lines 240-241 do that by examining `hPrevInst`, which stores the previous program's instance handle returned by `InitTask`. If this value is not zero, it identifies a previous task; therefore, the current task is not the first one and it's safe to assume the window class has already been registered. Otherwise, lines 242-282 initialize a `WNDCLASS` structure's members and pass the structure's address to the `RegisterClass` function (line 282).

As I mentioned, this chapter is not a full introduction to Windows programming, so I'll explain only a few key points of window registration. You can find complete descriptions of window class values in a Windows tutorial. Notice that line 242 uses `si` to hold the program's instance handle—a small but important optimization. In general, registers `si` and `di` are available for often-used values, but be sure to preserve these registers by pushing them onto the stack. Or as in `WHello`, list registers in a `USES` directive, (line 238) which automatically inserts the necessary push and pop instructions into the subroutine's prolog and epilog.

For demonstration purposes, I declared the `WNDCLASS` structure, `@@wc`, as a local variable on the stack (line 237). You don't have to do this—you could define global space for `wc`, perhaps in the program's uninitialized data segment. Because it is on the stack, however, `wc` is removed from existence after the `RegisterWin` subroutine returns. The structure isn't needed after this time, so it makes little sense to keep it in the global data segment.

Lines 247-248 assign the address of the window's callback function, `WndProc`, to `@@wc`. Because of this assignment, window elements created from the class have their messages processed by this important subroutine, which I'll explain in detail a bit later.

Lines 255-259 designate a system icon for the program's main window by pushing two arguments onto the stack and calling the Windows `LoadIcon` function. This sequence demonstrates an important, and often exasperating, aspect of programming Windows in assembly

language. Some arguments such as the program instance handle pushed from `si` at line 255 are 16-bit values. Others, such as the resource ID of the system icon, are 32-bit values, and therefore, require *two* push instructions as shown at lines 256-257. In all cases, when calling Windows functions, you must push the correct number of bytes onto the stack or serious problems might later develop. Always double check the number and sizes of functions arguments by referring to a Windows API reference and by disassembling small example programs written in C, Pascal, or another high-level language.

NOTE:

If you use strings to identify resources, push the string's segment address first followed by its offset. For example, you might use the instructions `push ds` and `push OFFSET id_icon` at lines 256-257. I prefer to identify resources by integer values, and for such values, it is necessary to push a zero flag value that represents a phony segment address. An application data segment address cannot be zero, and therefore, Windows recognizes this value as an indicator that the offset is an integer resource identifier rather than an address. If you know Windows programming in C, you'll recognize the instructions at lines 256-257 as the equivalent of the `MAKEINTRESOURCE` macro.

Lines 263-266 call another Windows function, which also requires two arguments—a 16-bit instance handle and a 32-bit resource identifier. The `call` instruction at line 266 specifies a cursor shape for the mouse cursor when it moves into the window's client area (the space inside the window's borders). After calling `LoadCursor`, the program transfers the return value in register `ax` to the `clshCursor` field (short for "window class cursor handle") in the window class structure.

After those and other assignments to the window class structure, the program calls `RegisterClass` to register the window class information. Lines 279-281 show how to pass a local stack variable by address to a function. Obviously, the variable's segment address is the same as the stack, so line 279 simply pushes `ss`. Line 280 loads the variable's stack offset into `ax` by using the `lea` (load effective address) instruction. Line 281 pushes the offset value onto the stack, and then line 282 calls `RegisterClass`. You can use similar code to pass other stack-based arguments to functions.

You don't have to use local variables as I did for `wc`. For example, if the program defined a global variable for the `WNDCLASS` structure, simply pass the address of that structure to `RegisterClass`. To make this change, first define `wc` with `UDATASEG` as follows:

```
UDATASEG
wc  WNDCLASS  ?
```

Then, in the `RegisterWin` subroutine, assign values to `wc`'s fields rather than to the local variable `@@wc`'s. (The code is otherwise identical.) Finally, pass the variable's address to `RegisterClass` with these instructions:

```
push ds           ; Push segment address of wc in the data segment
push OFFSET wc   ; Push offset address of wc
call RegisterClass ; Register window class using values in wc
```

NOTE

It is up to you to decide where to store your program's variables. The disadvantage of using a global variable in this case is that `wc` occupies memory even after the structure is no longer needed. The advantage is simpler code.

Window Creation

After the program registers its window class, the next job is to create an element of that class for use as the program's main window. Do this by calling another Windows function, `CreateWindow`. Also, memorize this rule: *Only the first program instance should register a window class, but every program instance must create its own window element of that class.*

NOTE

If you read the preceding chapter on object-oriented programming, or if you have some experience with OOP, you may notice similarities between window classes and window elements, as compared to objects and object instances (or in C++, classes and class objects). You might think of a window class as a data type that describes a window's characteristics. A window element is an instance of a window class—it represents one or more actual windows that have the class's characteristics. Most important, each window class has an associated window procedure, which is the rough equivalent of an object's methods (or in C++, its member functions). Window classes encapsulate data and code, just as objects and C++ classes do in OOP. This is not to suggest that Windows is object oriented, but it does employ the concepts of encapsulation, and to a limited extent, of inheritance in window classes.

The `CreateWindow` function requires a smorgasbord of arguments, pushed onto the stack by the instructions at lines 162-176. Here again, I won't cover each and every value, which most Windows tutorials explain. I commented each line, however, so you can compare the instructions with a C program's call to `CreateWindow`, which looks something like this:

```
WNDCLASS wc;
if (!hPrevInst) {
```

```

wc.style           = NULL;
wc.lpfWndProc     = WndProc;
wc.cbClsExtra     = 0;
wc.cbWndExtra     = 0;
wc.hInstance     = hInst;
wc.hIcon         = LoadIcon(hInst, MAKEINTRESOURCE(ID_ICON));
wc.hCursor       = LoadCursor(NULL, IDC_ARROW);
wc.hbrBackground = COLOR_WINDOW + 1;
wc.lpszMenuName  = MAKEINTRESOURCE(ID_MENU);
wc.lpszClassName = WndName;
RegisterClass(&wc);
}

```

If successful, `CreateWindow` returns a handle to the newly created window element. Line 178 stores this handle in `hWnd` for safekeeping, but you could also save it in a global variable for later use. Next, at lines 182-183, the program pushes the window handle onto the stack along with the global `cmdShow` value (returned by `InitTask` during the program's startup). Line 184 then calls `ShowWindow` to make the window visible. In C, the equivalent statement is:

```
ShowWindow(hWnd, nCmdShow);
```

TIP

When calling Windows functions, push argument values in the same left-to-right order as shown in the equivalent C statements. This works because Windows functions use the PASCAL calling convention. Also under this convention, functions remove all arguments from the stack on return, and therefore, you should not pop any function arguments you push onto the stack. In fact, doing so can destroy the stack and cause serious bugs.

Finally in subroutine `AppInit`, lines 188-189 call `UpdateWindow`, which isn't required, but causes the window's contents to be updated immediately by generating a `WM_PAINT` message. (The `WinApp` program at the end of this chapter shows how to handle this message.)

Eventually, the window's contents will be properly displayed anyway, and you may delete lines 188-189. It's a nice touch, however, to have a new program's window pop into view as quickly as possible. Calling `UpdateWindow` as shown here is one way to ensure that this happens.

The Message Loop

Up to now, all of the code that you have examined could be collected under the heading "Prelude to Symphony in WA" (WA for Windows Application, that is). The program is properly initialized, its window class is registered (if this is the first program instance), and an element of that window has been created for use as the program's main window. That window has been made visible and the window's contents, if any, have been displayed. It is time for the crescendo to crest and the cymbals to crash. Let the program's real music begin!

Maybe that's overly dramatic for a computer program, but in Windows terms, the main beat of an application is in its *message loop*. It is here that the program obtains messages that represent *events* such as mouse clicks and menu selections. The message loop routes messages to their proper destinations—usually one or more window procedures that carry out the event's actions.

Despite its importance, the message loop is a simple piece of code, as `WHello` demonstrates in the subroutine `AppRun` at lines 204-223. Even if you aren't a C programmer, it is helpful to compare the assembly language with the usual version written in C:

```
MSG msg;
while (GetMessage(&msg, NULL, NULL, NULL)) {
    TranslateMessage(&msg);
    DispatchMessage(&msg);
}
```

In `WHELLO.ASM`, lines 206-211 pass to `GetMessage` the address of a message structure variable, `msg`, along with three nulls representing unused parameters. `GetMessage` obtains the next message if any from the application's message queue. If the function returns zero, then the message received was `WM_QUIT` and the message loop should end (see lines 212-213). Otherwise, lines 214-216 call `TranslateMessage`, which converts virtual-key messages such as `WM_KEYDOWN` and `WM_KEYUP` into equivalent `WM_CHAR` character messages. Finally, lines 217-219 call `DispatchMessage`, which sends the message to the appropriate window procedure for processing.

The message loop uses a global variable, `msg`, of type `MSGSTRUCT` (defined at line 76). This is the assembly language equivalent to the `MSG` structure in C. It is appropriate to use a global uninitialized variable for the message structure because the message loop remains active for nearly the entire runtime life of the program. This also simplifies addressing. For example, compare references to `msg` in the message loop with the local window class structure `wc` in subroutine `RegisterWin` at lines 236-285.

NOTE

Notice how the message loop's `jmp` instruction at line 220 jumps to the local label `@@10` at line 205. It may seem just as well to jump to the beginning of the subroutine at label `AppRun`, but don't do that! When using a `MODEL` directive such as `PASCAL` and `WINDOWS`, Turbo Assembler inserts various prolog and epilog instructions in place of the `PROC` and `ENDP` directives. For example, if you use TDW's `View/CPU` command to inspect these instructions, you'll find instructions that save register `bp` and then assign it the current stack pointer `sp` for addressing stack-based parameters. If a `jmp` instruction returns to the beginning of the subroutine, the program will again execute the prolog instructions, which can cause a serious bug. To avoid this problem, always jump to a local label even though, from the source text, that label appears to be at the beginning of the subroutine.

The Window Procedure

Each message received by a program's message loop and sent to the `DispatchMessage` function must eventually be handled by a window procedure or by a default message handler in Windows. As I explained, a window procedure is a subroutine that is addressed by a window class structure (refer back to lines 247-248 in `WHELLO.ASM`). For example, if you move the mouse cursor into a window and click the right button, Windows sends the window procedure (via the program's message loop) a `WM_LBUTTONDOWN` message.

Much of Windows programming involves writing code for various messages that you expect to receive for a particular kind of window. You pass other messages to a default handler, usually `DefWindowProc` in the Windows API. The default handler performs routine operations such as opening menus, and moving and resizing windows.

A typical window procedure might contain programming for dozens of related and unrelated messages. For this reason, writing window procedures is sometimes called *event-driven programming*. Under this conceptual model, rather than write instructions that depend on their order of execution, you write code that responds independently to specific events such as mouse clicks and key presses. That code's order of execution depends on how users run the program, not on the placement of the program's instructions.

Following are a few key points to keep in mind when writing an event-driven window procedure. Line numbers refer to `WINHELLO.ASM`:

- A window procedure must be *reentrant*—that is, it must be capable of being called recursively. This rule is necessary because if the window procedure calls a Windows function, as is often the case, that function might trigger an event and generate a message *that leads to another call to the same window procedure before the current subroutine invocation returns*. It is possible for many such recursive calls to become stacked up like planes in fog over a busy airport, and writing to global variables in a reentrant subroutine is like ordering those planes fly in the same air space—a crash is nearly certain. For a safe landing, use local variables and arguments, and preserve any used registers (see lines 301-302).
- A window procedure should return a 32-bit value in registers `ax:dx`. For most messages, set both registers to zero if your code handles a message (see lines 312-313).
- Pass all unhandled messages to `DefWindowProc` as `WHELLO.ASM`'s window procedure demonstrates (lines 317-321). Return from the window procedure immediately after calling this function, thus passing `DefWindowProc`'s result in `ax:dx` back to the window procedure's caller.
- A main-window procedure must implement at least one message: `WM_DESTROY`. Call `PostQuitMessage` as `WHELLO.ASM` demonstrates (lines 310-311) in response to this message.

- Refer to a Windows API reference for requirements of specific messages and for the meanings of the `w` and `l` parameters. The purpose and use of these parameters vary widely among different messages.

With those points in mind, examine WHELLO's window procedure (refer to lines 300-324 in WHELLO.ASM). The procedure is declared a little differently from others in the sample listing:

```
PROC WndProc WINDOWS PASCAL FAR
```

You must use the `PROC` directive, and you must configure the procedure for `WINDOWS`. The subroutine must use the `PASCAL` calling convention and it must be `FAR`. Regardless of the program's memory model, Windows calls the function using a full 32-bit address, and the subroutine must return by using a far-return instruction. Because the `PROC` directive includes the `FAR` key word, Turbo Assembler automatically supplies this instruction in place of `ret` at line 323.

Line 301 is also required. It declares four parameters that Windows passes on the stack to the window procedure:

```
ARG hWnd:WORD, uMsg:WORD, w:WORD, l:DWORD
```

- `hWnd:WORD` is the handle of the window element for which this message is intended.
- `uMsg:WORD` is the unsigned integer value of the message.
- `w:WORD` is an optional 16-bit value passed along with the message. Its purpose and meaning depend on the message.
- `l:DWORD` is an optional 32-bit value passed along with the message. Its purpose and meaning depend on the message.

Line 302 employs the `USES` directive to automatically save and restore register `si`, which the window procedure uses to hold a copy of the message value in the stack variable `uMsg`. If your code also uses `di`, be sure to add it to the `USES` directive:

```
USES si, di
```

You don't have to store values in `si` and `di`, but using a register is always more efficient than a memory reference. Because a lengthy window procedure might have to process dozens of messages, it's usually best to copy the message value into `si` (or another register) as line 304 demonstrates. Next, compare that value with one of the messages your code handles. In this case, the sample window procedure handles only a single message, `WM_DESTROY`. If `si` equals that message value, line 306 jumps to the section that handles it; otherwise, line 307 jumps to a default handler.

NOTE

By convention, I use local labels such as `@WMDESTROY` for the code that handles the `WM_DESTROY` message. You can name your window procedure labels as you wish, but my convention helps identify what messages each section processes.

Lines 309-314 handle the `WM_DESTROY` message by calling the Windows API function `PostQuitMessage`. After calling this function, the window procedure sets `ax:dx` to zero, which indicates to Windows that the message has been successfully handled. Line 314 then jumps to the `ret` instruction that ends the procedure.

Lines 316-321 demonstrate the correct way to process unhandled messages. First, push the window handle, the message value (in `si` if you use this register), the optional word, and the double word parameters. Then call `DefWindowProc` to handle the message. Immediately return from the window procedure after this call, thus passing back the return value in `ax:dx` from `DefWindowProc`.

In a fully fledged Windows application, a window procedure will be much more complex than the relatively simple one in `WHELLO.ASM`. The sample code, however, demonstrates the basic structure of all window procedures. In the next section's sample program, you learn how to expand this structure to process other types of messages.

Linker Definition File

Before turning to a more involved sample program, you need to examine two additional files that are required for creating a Windows executable code file. The first file, `WHELLO.DEF` (refer back to Listing 15.2) is called a *linker definition file*. It specifies the size of the heap (where dynamic variables created at runtime can be stored) the stack, and other items.

Most Windows tutorials and development systems explain linker definition-file options. I'll cover only those used here. Line numbers refer to Listing 15.2:

1. `NAME` is the name of the application, and should normally equal its code-file name minus any filename extension. This name is unquoted.
2. `DESCRIPTION` is any string delimited with single quotes. Most programmers insert the application name, version, and a copyright notice. The string is embedded into the executable code file.
3. `EXETYPE` must be `WINDOWS`. Some references indicate that a Windows version number may be used here (`WINDOWS 3.1` for example), but Turbo Linker does not recognize this format.

4. `STUB` specifies the name of a DOS program that is executed if a user attempts to run the program from a DOS prompt (which is not permitted). Usually, the stub simply displays the message “This program must be run under Microsoft Windows” and ends, but the stub can perform any action you need. In fact, you can combine a Windows application with *any* DOS program simply by specifying a different stub, and in this way, you create a dual DOS/Windows executable code file. Some installation utilities use this trick so they may be executed as DOS or Windows programs. The `WINSTUB.EXE` code file indicated here is supplied by Borland C++ and is usually found in the directory `C:\BC4\BIN`. This directory must be on the system `PATH` so the linker can find the stub.
5. `CODE` specifies the attributes of the program’s code segment. Most applications should use the three options shown here, which preload the code into memory when the program is executed, permit Windows to move the code if necessary to make room in memory, and also permit Windows to discard the code segment temporarily from memory when the program is inactive.
6. `DATA` specifies the attributes of the program’s data segment. Most applications should use the three options shown here, which preload initialized variables when the application is run, allow Windows to move the data segment to make room in memory, and also create a new data segment for each program instance.
7. `HEAPSIZE` selects the size of the heap in bytes. Windows stores dynamic variables such as graphics brushes and some other items on the heap. (The use of heaps in assembly language is beyond the scope of this chapter, but is essentially the same as in C or Pascal.) Use a value at least as large as shown here.
8. `STACKSIZE` specifies the size of the program’s stack. Use a value at least as large as shown here.
9. `EXPORTS` lists any subroutines exported to Windows—for example, a window procedure called by Windows. Because `WndProc` is declared public in the source text, (see line 49 in `WHELLO.ASM`), the `EXPORTS` directive is redundant and you can delete it.

Resource Script File

The final file in the mix contains resource script instructions, which configure the program’s resources. A resource is any binary data that is stored in the program’s executable code file. Instructions in the program load resources into memory from the code file image, and use those resources for a variety of purposes.

For example, a program’s menu commands are usually stored in a menu resource. A system icon can be stored as an icon resource. A dialog box with all of its buttons and controls are stored in a dialog resource, and so on. You can also create your own resources, which can have any values you desire.

Listing 15.3, WHELLO.RC, lists the sample application's sole resource, an icon stored on disk in the bitmap file WHELLO.ICO. Resource scripts are compiled by a resource compiler, usually Microsoft's RC.EXE utility supplied with most Windows development systems (but not with Turbo Assembler). In addition to RC.EXE, Borland C++ also supplies its own BRC.EXE utility, which is functionally equivalent to RC, but runs faster.

When you compile a resource script file, you create a binary version of the script in a file that ends with the extension .RES. Compiling WHELLO.RC with this command, for example, creates WHELLO.RES:

```
brc whello.rc
```

The instruction at line 3 in WHELLO.RC copies the icon file WHELLO.ICO to WHELLO.RES, which the linker binds into the program's code file, WHELLO.EXE. The WHELLO.ICO and WHELLO.RES files are therefore not needed at runtime—the executable code file contains the entire application, including its resources.

The script file (see line 1 of WHELLO.RC) also defines ID_ICON, using C-style notation, to represent this resource. One problem with assembly language programming for Windows is that the script compiler does not recognize EQU directives. You therefore must define each resource identifier twice—using C-style #define directives in the resource script, and again using EQU directives in the assembly language. (See, for example, line 53 in WHELLO.ASM.)

Developing Windows Applications with TASM

The following listings show more about writing Windows applications in assembly language. The demonstration program executes a dialog box, has a popup menu, displays graphics in a window, and uses a message box to prompt users whether to quit the program.

I selected these features because they demonstrate typical code that you will need in most Windows programs. There's still a lot more to Windows programming than explained here, but you should be able to use the following listings as guidelines for many different types of applications.

Windows Application Shell

All of WinApp's files are listed together in this section. After the listings, I describe how the program works. Unless stated otherwise, all line number references are to WINAPP.ASM. Following is an inventory of the program's files. Figure 15.2 shows the program's display, including its simple graphics (the rectangle inside the window's borders) and popup menu.

- Listing 15.4, WINAPP.ASM, contains the program's instructions.

Figure 15.2.

WinApp's display with simple graphics and a popup menu.

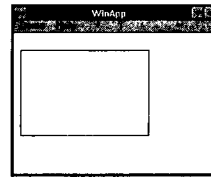

- Listing 15.5, WINAPP.DEF, the linker definition file, configures code and data segments and supplies miscellaneous information to the linker.
- Listing 15.6, WINAPP.RC, is the program's resource script. It specifies an icon, a menu, and a dialog box. To compile this resource script you need a resource compiler and the WINDOWS.H header file supplied with all Windows C and C++ development systems. Turbo Assembler does not provide these items.
- Listing 15.7, WINAPP.RH, defines resource identifiers using C-style #define directives. This file is included into the resource script.
- Listing 15.8, WINAPP.RI, defines the equivalent resource identifiers using assembly language EQU directives. This file is included into WINAPP.ASM.

Listing 15.4. WINAPP.ASM.

```

1: %TITLE "Windows application shell in assembly language -- by Tom Swan"
2:
3:         IDEAL
4:
5:         JUMPS
6:
7:         P286
8:
9:         LOCALS @@
10:
11:        MODEL    large, WINDOWS PASCAL
12:
13: ;----- Include Windows declarations (MASM mode required)
14:
15:        %NOINCL
16:
17:        MASM
18:
19:        INCLUDE windows.inc
20:
21:        IDEAL
22:
23: ;----- Include resource identifiers
24:
25:        INCLUDE "winapp.ri"
26:
27: ;----- Define external functions imported from Windows
28:

```

```

29: EXTRN   InitTask:PROC
30: EXTRN   WaitEvent:PROC
31: EXTRN   InitApp:PROC
32: EXTRN   LoadIcon:PROC
33: EXTRN   LoadCursor:PROC
34: EXTRN   CreateWindow:PROC
35: EXTRN   ShowWindow:PROC
36: EXTRN   UpdateWindow:PROC
37: EXTRN   RegisterClass:PROC
38: EXTRN   GetMessage:PROC
39: EXTRN   TranslateMessage:PROC
40: EXTRN   DispatchMessage:PROC
41: EXTRN   PostQuitMessage:PROC
42: EXTRN   DefWindowProc:PROC
43: EXTRN   SendMessage:PROC
44: EXTRN   MakeProcInstance:PROC
45: EXTRN   FreeProcInstance:PROC
46: EXTRN   DialogBox:PROC
47: EXTRN   EndDialog:PROC
48: EXTRN   MessageBox:PROC
49: EXTRN   DestroyWindow:PROC
50: EXTRN   BeginPaint:PROC
51: EXTRN   EndPaint:PROC
52: EXTRN   Rectangle:PROC
53:
54: ;----- Define global program procedures called internally
55:
56: GLOBAL   PASCAL   WinMain:PROC
57: GLOBAL   PASCAL   AppInit:PROC
58: GLOBAL   PASCAL   AppRun:PROC
59: GLOBAL   PASCAL   RegisterWin:PROC
60: GLOBAL   PASCAL   WinAppCommands:PROC
61: GLOBAL   PASCAL   HelpAbout:PROC
62:
63: ;----- Define program procedures exported to Windows
64:
65: PUBLIC   WndProc
66: PUBLIC   DlgProc
67:
68: ;----- Global initialized variables
69:
70:         DATASEG
71:
72: ;----- The following 16-byte buffer must be first in the program's
73: ;         data segment. Windows uses this area for its own purposes.
74:
75:         DB   16 DUP (0)           ; Reserved for Windows
76: exCode   DB   0                   ; Exit code returned to DOS
77: szAppName DB   'WinApp', 0       ; App name or window title
78: szWndName DB   'WinAppWin', 0   ; Window class name
79: szDlgString DB   'End program?', 0 ; Message-box string
80:
81: ;----- Global uninitialized variables
82:

```

continues

Listing 15.4. continued

```

83:          UDATASEG
84:
85: psp          DW      ?          ; Program segment prefix
86: pszCmdLine   DW      ?          ; Pointer to command line string
87: hPrevInst    DW      ?          ; Handle to previous instance
88: hInstance    DW      ?          ; Handle to this instance
89: cmdShow      DW      ?          ; Window display style
90: msg          MSGSTRUCT ?       ; Message loop structure
91: ps          PAINTSTRUCT ?      ; WM_PAINT structure
92:
93:          CODESEG
94:
95: Start:
96:
97: ;----- Begin required initializations
98:
99:          call   InitTask          ; Initialize this task
100:         or     ax, ax             ; Test result in ax
101:         jnz   @@InitTaskOk       ; Continue if ax is not zero
102:         jmp   @@InitFail         ; Else exit with error code
103:
104: @@InitTaskOk:
105:
106: ;----- Save various items returned by InitTask
107:
108:         mov   [psp], es           ; Program segment prefix
109:         mov   [pszCmdLine], bx    ; Pointer to command line (es:bx)
110:         mov   [hPrevInst], si    ; Previous program instance handle
111:         mov   [hInstance], di    ; This program instance handle
112:         mov   [cmdShow], dx      ; Window display style
113:
114: ;----- Continue required initializations
115:
116:         push  0                   ; Push task ID (0 = current task)
117:         call  WaitEvent           ; Clear any waiting events
118:         push  di                  ; Push program instance handle
119:         call  InitApp             ; Initialize application queue
120:         or   ax, ax              ; Test result in ax
121:         jnz  @@InitAppOk         ; Continue if InitApp successful
122:         jmp  @@InitFail         ; Else exit with error code
123:
124: @@InitAppOk:
125:
126:         call  WinMain             ; Inits done--start application
127:         jmp   Exit               ; Jump to exit
128:
129: @@InitFail:
130:
131:         mov   [exCode], 0ffh     ; Startup error code = -1
132:
133: Exit:    mov   ah, 04Ch           ; DOS function: Exit program
134:         mov   al, [exCode]       ; Return exit code value
135:         int   21h               ; Call DOS. Terminate program
136: %NEWPAGE

```

```

137: ;-----
138: ; WinMain          Equivalent to WinMain in a C program
139: ;-----
140: ; Input:
141: ;   none
142: ;   Note:   This procedure isn't required, but it permits Turbo
143: ;           Debugger to skip over the startup code and begin
144: ;           tracing here. Apparently, this happens because TD
145: ;           recognizes WinMain as the application entry point.
146: ; Output:
147: ;   none
148: ; Registers:
149: ;   none
150: ;-----
151: PROC   WinMain PASCAL
152:       call   AppInit           ; Initialize application
153:       call   AppRun           ; Execute message loop
154:       ret
155: ENDP   WinMain
156: %NEWPAGE
157: ;-----
158: ; AppInit          Register and create the app's window
159: ;-----
160: ; Input:
161: ;   hPrevInst      Handle to previous instance (global)
162: ;   hInstance      Handle to this instance (global)
163: ;   cmdShow        Window display style (global)
164: ; Output:
165: ;   none
166: ; Registers:
167: ;   ax
168: ;-----
169: PROC   AppInit PASCAL
170:       USES   di, si
171:
172:       call   RegisterWin       ; Register program's main window
173:       mov    si, [hInstance]   ; Use si to hold instance handle
174:
175: ;----- Create element of window from registered window class
176:
177:       push   ds                ; Segment for szWndName
178:       push   OFFSET szWndName  ; The window's class name
179:       push   ds                ; Segment for szAppName
180:       push   OFFSET szAppName  ; Caption for title bar
181:       push   WS_OVERLAPPEDWINDOW ; The window's style
182:       push   0                 ; Low word of Style
183:       push   CW_USEDEFAULT     ; Starting x coordinate
184:       push   CW_USEDEFAULT     ; Starting y coordinate
185:       push   CW_USEDEFAULT     ; Starting width
186:       push   CW_USEDEFAULT     ; Starting height
187:       push   0                 ; Handle to parent window (none)
188:       push   0                 ; Handle to menu (none)
189:       push   si                ; Program instance handle
190:       push   0                 ; Optional user parameters (none)

```

continues

Listing 15.4. continued

```

191:      push    0                ; Optional user parameters (none)
192:      call   CreateWindow      ; Create window element
193:      mov    di, ax            ; Save window handle in di
194:
195: ;----- Begin process of showing main window
196:
197:      push   di                ; Push window handle
198:      push   [cmdShow]         ; Push window style
199:      call   ShowWindow        ; Make window visible
200:
201: ;----- Force immediate painting of window contents
202:
203:      push   di                ; Push window handle
204:      call   UpdateWindow      ; Update window contents
205:
206:      ret
207: ENDP   AppInit
208: %NEWPAGE
209: ;-----
210: ; AppRun                Run the application (the "message loop")
211: ;-----
212: ; Input:
213: ; none
214: ; Output:
215: ; none
216: ; Registers:
217: ; ax
218: ;-----
219: PROC   AppRun   PASCAL
220: @@10:  push   ds                ; Push msg segment address
221:      push   OFFSET msg         ; Push msg offset address
222:      push   NULL               ; Unused
223:      push   NULL               ; Unused
224:      push   NULL               ; Unused
225:      call   GetMessage         ; Get next message
226:      or    ax, ax              ; Did GetMessage return zero?
227:      jz    @@99                ; If yes, exit loop
228:      push   ds                ; Push msg segment address
229:      push   OFFSET msg         ; Push msg offset address
230:      call   TranslateMessage   ; Translate keyboard messages
231:      push   ds                ; Push msg segment address
232:      push   OFFSET msg         ; Push msg offset address
233:      call   DispatchMessage   ; Send message to window proc
234:      jmp   @@10                ; Loop until app ends
235: @@99:  ret
236: ENDP   AppRun
237: %NEWPAGE
238: ;-----
239: ; RegisterWin          Register the program's main window class
240: ;-----
241: ; Input:
242: ; hPrevInst   Handle to previous instance (global)
243: ; hInstance   Handle to this instance (global)
244: ; Output:

```

```

245: ; none
246: ; Registers:
247: ; ax
248: ;-----
249: PROC RegisterWin PASCAL
250: LOCAL @wc:WNDCLASS ; Allocate structure on stack
251: USES di, si ; Preserve registers
252:
253: cmp [hPrevInst], 0 ; Is a prior instance running?
254: jne @e99 ; If yes, jump to exit
255: mov si, [hInstance] ; Use si to hold instance handle
256:
257: ;---- Assign values to global window class structure @wc
258:
259: mov [@@wc.clsStyle], NULL
260: mov [WORD PTR @wc.clsLpfnWndProc ], OFFSET WndProc
261: mov [WORD PTR (@wc.clsLpfnWndProc) + 2], SEG WndProc
262: mov [@@wc.clsCbClsExtra], 0
263: mov [@@wc.clsCbWndExtra], 0
264: mov [@@wc.clsHInstance], si
265:
266: ;---- Get and assign icon handle from app's resources
267:
268: push si ; Program instance handle
269: push 0 ; High word of resource ID
270: push ID_ICON ; Low word of resource ID
271: call LoadIcon ; Load icon from app's resources
272: mov [@@wc.clsHIcon], ax ; Save resulting icon handle
273:
274: ;---- Get and assign a cursor handle
275:
276: push 0 ; Instance handle (none)
277: push 0 ; High word of resource ID
278: push IDC_ARROW ; Low word of resource ID
279: call LoadCursor ; Load standard cursor
280: mov [@@wc.clsHCursor], ax ; Save resulting cursor handle
281:
282: ;---- Assign remaining window class structure values
283:
284: mov [@@wc.clsHbrBackground], COLOR_WINDOW + 1
285: mov [WORD PTR @wc.clsLpszMenuName ], ID_MENU
286: mov [WORD PTR (@wc.clsLpszMenuName) + 2 ], 0
287: mov [WORD PTR @wc.clsLpszClassName ], OFFSET szWndName
288: mov [WORD PTR (@wc.clsLpszClassName) + 2], ds
289:
290: ;---- Register the window class
291:
292: push ss ; Push segment of wc
293: lea ax, [@@wc] ; Load ax with wc offset
294: push ax ; Push offset of wc
295: call RegisterClass ; Register the window class

```

continues

Listing 15.4. continued

```

296: @@99:
297:         ret
298: ENDP   RegisterWin
299: %NEWPAGE
300: ;-----
301: ; WndProc                Main Window Procedure (called by Windows)
302: ;-----
303: ; Input:
304: ;   hWnd                WORD (stack)   Handle to window
305: ;   uMsg                WORD (stack)   Message identifier
306: ;   wp                  WORD (stack)   Optional word parameter
307: ;   lp                  DWORD (stack)  Optional double word parameter
308: ; Output:
309: ;   Depends on message
310: ; Registers:
311: ;   ax, dx
312: ;-----
313: PROC    WndProc WINDOWS PASCAL FAR
314:     ARG  hWnd:WORD, uMsg:WORD, wp:WORD, lp:DWORD
315:     USES di, si
316:
317:     mov  di, [hWnd]           ; Use di to hold window handle
318:     mov  si, [uMsg]          ; Use si to hold message
319:     cmp  si, WM_DESTROY     ; Is message WM_DESTROY?
320:     je   @@WMDESTROY        ; If yes, jump to process message
321:     cmp  si, WM_CLOSE       ; Is message WM_CLOSE?
322:     je   @@WMCLOSE         ; If yes, jump to process message
323:     cmp  si, WM_PAINT       ; Is message WM_PAINT?
324:     je   @@WMPAINT         ; If yes, jump to process message
325:     cmp  si, WM_COMMAND     ; Is message WM_COMMAND?
326:     je   @@WMCOMMAND       ; If yes, jump to process message
327:     jmp  @@DEFWINDOWPROC    ; Else jump to default processor
328:
329: ;----- Process WM_DESTROY message
330:
331: @@WMDESTROY:
332:     push 0                   ; Push user-defined exit code
333:     call PostQuitMessage     ; Call Windows to post WM_QUIT msg
334:     jmp  @@RETURNZERO       ; Return 0L (long 32-bit zero)
335:
336: ;----- Process WM_CLOSE message
337:
338: @@WMCLOSE:
339:     push di                   ; Push window handle
340:     push ds                   ; Push segment of dialog string
341:     push OFFSET szDlgString  ; Push offset of dialog string
342:     push ds                   ; Push segment of title string
343:     push OFFSET szAppName    ; Push offset of title string
344:     push MB_ICONQUESTION OR MB_YESNO ; Push message-box styles
345:     call MessageBox         ; Call Windows function
346:     cmp  ax, IDYES           ; Did user select Yes button?
347:     jne  @@RETURNZERO       ; If no, exit WM_CLOSE processor
348:     push di                   ; Else push window handle
349:     call DestroyWindow       ; Destroy window and end program
350:     jmp  @@RETURNZERO       ; Return 0L (long 32-bit zero)
351:

```

```

352: @@WMPAINT:
353:     push    di                ; Push window handle
354:     push    ds                ; Push segment of ps structure
355:     push    OFFSET ps         ; Push offset of ps structure
356:     call    BeginPaint        ; Initiate GDI painting
357:     mov     si, ax            ; Save device context handle in si
358:
359: ;----- Call a GDI function
360:
361:     push    si                ; Push HDC
362:     push    10                ; Push rectangle coordinates
363:     push    25
364:     push    200
365:     push    150
366:     call    Rectangle         ; Draw the rectangle
367:
368: ;----- Insert other GDI function calls here
369:
370:     push    di                ; Push window handle
371:     push    ds                ; Push segment of ps structure
372:     push    OFFSET ps         ; Push offset of ps structure
373:     call    EndPaint          ; End GDI painting
374:     jmp     @RETURNZERO       ; Return 0L (long 32-bit zero)
375:
376: ;----- Process WM_COMMAND message
377:
378: @@WMCOMMAND:
379:     push    di                ; Push window handle
380:     push    [wp]              ; Push word parameter
381:     push    [lp]              ; Push long parameter
382:     call    WinAppCommands    ; Call our command handler
383:     jmp     @RETURNZERO       ; Return 0L (long 32-bit zero)
384:
385: ;----- Call Windows default message handler
386:
387: @@DEFWINDOWPROC:
388:     push    di                ; Push window handle
389:     push    si                ; Push message value
390:     push    [wp]              ; Push optional word parameter
391:     push    [lp]              ; Push optional long parameter
392:     call    DefWindowProc     ; Call default message handler
393:     jmp     @@99              ; Return DefWindowProc result
394:
395: @@RETURNZERO:
396:     xor     ax, ax            ; Return 0L (DWORD zero) in ax:dx
397:     xor     dx, dx
398: @@99:
399:     ret
400: ENDP    WndProc

```

continues

Listing 15.4. continued

```

401: %NEWPAGE
402: ;-----
403: ; DlgProc          Dialog procedure (called by Windows)
404: ;-----
405: ; Input:
406: ;   hWndDlg      WORD (stack)   Handle to dialog window
407: ;   uMsg         WORD (stack)   Message identifier
408: ;   wp           WORD (stack)   WM_COMMAND identifier
409: ;   lp           DWORD (stack)  Optional double word parameter
410: ; Output:
411: ;   Depends on message
412: ; Registers:
413: ;   ax
414: ;-----
415: PROC   DlgProc WINDOWS PASCAL FAR
416:     ARG   hWndDlg:WORD, uMsg:WORD, wp:WORD, lp:DWORD
417:     USES  si
418:
419:     mov   si, [uMsg]           ; Use si to hold message
420:     cmp   si, WM_INITDIALOG   ; Is it WM_INITDIALOG?
421:     je    @@WMINITDIALOG     ; If yes, jump to process message
422:     cmp   si, WM_COMMAND      ; Is it WM_COMMAND?
423:     je    @@WMCOMMAND        ; If yes, jump to process message
424:     jmp   @@RETURNFALSE      ; Other messages--exit
425:
426: ;----- Process WM_INITDIALOG message
427:
428: @@WMINITDIALOG:              ; Insert any initializations here
429:     jmp   @@RETURNTRUE       ; Exit and return TRUE
430:
431: ;----- Process WM_COMMAND message (for dialog buttons, etc.)
432:
433: @@WMCOMMAND:
434:     mov   si, [wp]           ; Use si to hold WM_COMMAND id
435:     cmp   si, IDOK          ; Is it IDOK?
436:     je    @@IDOK            ; If yes, jump to process command
437:     jmp   @@RETURNFALSE     ; Else exit and return FALSE
438:
439: ;----- Process IDOK command (e.g. when user selects the OK button)
440:
441: @@IDOK:
442:     push  [hWndDlg]         ; Push dialog window handle
443:     push  0                 ; Push value to return to caller
444:     call  EndDialog         ; End the dialog
445:     jmp   @@RETURNTRUE     ; Enable to add more commands
446:
447: @@RETURNTRUE:
448:     mov   ax, TRUE          ; Return BOOL true value
449:     jmp   @@99
450:
451: @@RETURNFALSE:
452:     mov   ax, FALSE        ; Return BOOL false value
453: @@99:   ret
454: ENDP   DlgProc

```

```

455: %NEWPAGE
456: ;-----
457: ; WinAppCommands      Menu command subroutine
458: ;-----
459: ; Input:
460: ;   hWnd      WORD (stack)   Handle to window
461: ;   wp        WORD (stack)   Word parameter (command ID)
462: ;   lp        DWORD (stack)  Optional double word parameter
463: ; Output:
464: ;   none
465: ; Registers:
466: ;   none
467: ;-----
468: PROC   WinAppCommands PASCAL
469:     ARG   hWnd:WORD, wId:WORD, lp:DWORD
470:     USES  di, si
471:
472:     mov   di, [hWnd]           ; Move window handle into di
473:     mov   si, [wId]           ; Move command ID into si
474:     cmp   si, CM_DEMO_EXIT    ; Is command CM_DEMO_EXIT?
475:     je    @@CMDEMOEXIT       ; If yes, jump to process
476:     cmp   si, CM_HELP_ABOUT   ; Is command CM_HELP_ABOUT?
477:     je    @@CMHELPAABOUT    ; If yes, jump to process
478:     jmp   @@e99              ; Unrecognized command -- exit
479:
480: ;----- Process the menu's Demo:Exit command
481:
482: @@CMDEMOEXIT:
483:     push  di                  ; Push window handle
484:     push  WM_CLOSE           ; Push message to send
485:     push  0                  ; Push unused word parameter
486:     push  0                  ; Push unused long parameter (1)
487:     push  0                  ; Push unused long parameter (2)
488:     call  SendMessage        ; Send WM_CLOSE message
489:     jmp   @@e99
490:
491: ;----- Process the menu's Help:About command
492:
493: @@CMHELPAABOUT:
494:     push  di                  ; Push window handle
495:     call  HelpAbout          ; Call our about-box subroutine
496:     jmp   @@e99              ; Enable to add more commands
497:
498: @@e99:  ret
499: ENDP   WinAppCommands
500: %NEWPAGE
501: ;-----
502: ; HelpAbout      About box subroutine
503: ;-----
504: ; Input:
505: ;   hWnd      WORD (stack)   Handle to dialog-owner window
506: ; Output:
507: ;   none
508: ; Registers:
509: ;   none
510: ;-----

```

Listing 15.4. continued

```

401: %NEWPAGE
402: ;-----
403: ; DlgProc                Dialog procedure (called by Windows)
404: ;-----
405: ; Input:
406: ; hWndDlg      WORD (stack)   Handle to dialog window
407: ; uMsg         WORD (stack)   Message identifier
408: ; wp           WORD (stack)   WM_COMMAND identifier
409: ; lp           DWORD (stack)  Optional double word parameter
410: ; Output:
411: ; Depends on message
412: ; Registers:
413: ; ax
414: ;-----
415: PROC    DlgProc WINDOWS PASCAL FAR
416:     ARG    hWndDlg:WORD, uMsg:WORD, wp:WORD, lp:DWORD
417:     USES   si
418:
419:     mov    si, [uMsg]                ; Use si to hold message
420:     cmp    si, WM_INITDIALOG         ; Is it WM_INITDIALOG?
421:     je     @@WMINITDIALOG           ; If yes, jump to process message
422:     cmp    si, WM_COMMAND            ; Is it WM_COMMAND?
423:     je     @@WMCOMMAND              ; If yes, jump to process message
424:     jmp    @@RETURNFALSE            ; Other messages--exit
425:
426: ;----- Process WM_INITDIALOG message
427:
428: @@WMINITDIALOG:                    ; Insert any initializations here
429:     jmp    @@RETURNTRUE              ; Exit and return TRUE
430:
431: ;----- Process WM_COMMAND message (for dialog buttons, etc.)
432:
433: @@WMCOMMAND:
434:     mov    si, [wp]                  ; Use si to hold WM_COMMAND id
435:     cmp    si, IDOK                  ; Is it IDOK?
436:     je     @@IDOK                    ; If yes, jump to process command
437:     jmp    @@RETURNFALSE            ; Else exit and return FALSE
438:
439: ;----- Process IDOK command (e.g. when user selects the OK button)
440:
441: @@IDOK:
442:     push  [hWndDlg]                  ; Push dialog window handle
443:     push  0                          ; Push value to return to caller
444:     call  EndDialog                  ; End the dialog
445:     jmp    @@RETURNTRUE              ; Enable to add more commands
446:
447: @@RETURNTRUE:
448:     mov    ax, TRUE                  ; Return BOOL true value
449:     jmp    @@99
450:
451: @@RETURNFALSE:
452:     mov    ax, FALSE                 ; Return BOOL false value
453:     ret
454: ENDP    DlgProc

```

```

455: %NEWPAGE
456: ;-----
457: ; WinAppCommands      Menu command subroutine
458: ;-----
459: ; Input:
460: ;   hWnd      WORD (stack)   Handle to window
461: ;   wp        WORD (stack)   Word parameter (command ID)
462: ;   lp        DWORD (stack)  Optional double word parameter
463: ; Output:
464: ;   none
465: ; Registers:
466: ;   none
467: ;-----
468: PROC   WinAppCommands PASCAL
469:     ARG   hWnd:WORD, wId:WORD, lp:DWORD
470:     USES  di, si
471:
472:     mov   di, [hWnd]           ; Move window handle into di
473:     mov   si, [wId]           ; Move command ID into si
474:     cmp   si, CM_DEMO_EXIT    ; Is command CM_DEMO_EXIT?
475:     je    @@CMDEMOEXIT        ; If yes, jump to process
476:     cmp   si, CM_HELP_ABOUT   ; Is command CM_HELP_ABOUT?
477:     je    @@CMHELPAABOUT     ; If yes, jump to process
478:     jmp   @@99                ; Unrecognized command -- exit
479:
480: ;----- Process the menu's Demo:Exit command
481:
482: @@CMDEMOEXIT:
483:     push  di                   ; Push window handle
484:     push  WM_CLOSE             ; Push message to send
485:     push  0                    ; Push unused word parameter
486:     push  0                    ; Push unused long parameter (1)
487:     push  0                    ; Push unused long parameter (2)
488:     call  SendMessage          ; Send WM_CLOSE message
489:     jmp   @@99
490:
491: ;----- Process the menu's Help:About command
492:
493: @@CMHELPAABOUT:
494:     push  di                   ; Push window handle
495:     call  HelpAbout            ; Call our about-box subroutine
496:     jmp   @@99                ; Enable to add more commands
497:
498: @@99:  ret
499: ENDP   WinAppCommands
500: %NEWPAGE
501: ;-----
502: ; HelpAbout      About box subroutine
503: ;-----
504: ; Input:
505: ;   hWnd      WORD (stack)   Handle to dialog-owner window
506: ; Output:
507: ;   none
508: ; Registers:
509: ;   none
510: ;-----

```

Listing 15.4. continued

```

511: PROC    HelpAbout PASCAL
512:        ARG    hWnd:WORD
513:        USES   di, si
514:
515:        push   SEG DlgProc           ; Push dialog procedure segment
516:        push   OFFSET DlgProc       ; Push dialog procedure offset
517:        push   [hInstance]         ; Push program instance handle
518:        call   MakeProcInstance     ; Make procedure instance
519:        mov    di, dx               ; Save segment address in di
520:        mov    si, ax               ; Save offset address in si
521:
522:        push   [hInstance]         ; Push program instance handle
523:        push   0                    ; Push segment value (0 = flag)
524:        push   ID_ABOUT             ; Push dialog box resource ID
525:        push   [hWnd]              ; Push owning window handle
526:        push   di                   ; Push procedure instance segment
527:        push   si                   ; Push procedure instance offset
528:        call   DialogBox           ; Execute dialog box
529:
530:        push   di                   ; Push procedure instance segment
531:        push   si                   ; Push procedure instance offset
532:        call   FreeProcInstance     ; Free procedure instance
533:
534:        ret
535: ENDP    HelpAbout
536:
537:        END    Start                ; End of program / entry point

```

Listing 15.5. WINAPP.DEF.

```

1: NAME            WINAPP
2: DESCRIPTION     'WinApp v1.00 (C) 1995 by Tom Swan'
3: EXETYPE        WINDOWS
4: STUB           'WINSTUB.EXE'
5: CODE           PRELOAD MOVEABLE DISCARDABLE
6: DATA         PRELOAD MOVEABLE MULTIPLE
7: HEAPSIZE      1024
8: STACKSIZE     8192
9: EXPORTS       WndProc
10:              DlgProc

```

Listing 15.6. WINAPP.RC.

```

1: #include <windows.h>
2: #include "winapp.rh"
3:
4: ID_ICON ICON winapp.ico
5:
6: ID_MENU MENU
7: BEGIN
8:     POPUP "&Demo"

```

```

9: BEGIN
10: MENUITEM "E&xit", CM_DEMO_EXIT
11: END
12: POPUP "&Help"
13: BEGIN
14: MENUITEM "&About...", CM_HELP_ABOUT
15: END
16: END
17:
18: ID_ABOUT DIALOG 6, 15, 180, 98
19: STYLE WS_DLGFRAME | WS_POPUP
20: CAPTION "About WAbout"
21: {
22: DEFPUSHBUTTON "OK", IDOK, 13, 47, 16, 40
23: ICON ID_ICON, -1, 12, 16, 18, 16
24: CONTROL "", -1, "static", SS_BLACKFRAME, 42, 8, 133, 81
25: LTEXT "WinApp v1.00", -1, 55, 18, 112, 8
26: LTEXT "Copyright \251 1995 by Tom Swan", -1, 54, 35, 112, 8
27: LTEXT "All rights reserved", -1, 55, 52, 112, 8
28: LTEXT "From Mastering Turbo Assembler 2nd Ed", -1, 55, 69, 112, 8
29: }

```

Listing 15.7. WINAPP.RH.

```

1: // =====
2: // winapp.rh -- Resource constants (resource or C modules)
3: // =====
4:
5: // Resource identifiers
6:
7: #define ID_ICON          100
8: #define ID_MENU         100
9: #define ID_ABOUT        100
10:
11: // Menu command identifiers
12:
13: #define CM_DEMO_EXIT    101
14: #define CM_HELP_ABOUT   999

```

Listing 15.8. WINAPP.RI.

```

1: ; =====
2: ; winapp.ri -- Resource constants (assembly language modules)
3: ; =====
4:
5: ; Resource identifiers
6:
7: ID_ICON          EQU      100
8: ID_MENU          EQU      100
9: ID_ABOUT         EQU      100
10:

```

continues

Listing 15.8. continued

```
11: ; Menu command identifiers
12:
13: CM_DEMO_EXIT EQU 101
14: CM_HELP_ABOUT EQU 999
```

How to Assemble WinApp

Use the same commands to assemble and link WinApp that you used for WHello. Change to the WIN\WINAPP directory and type `make`, or use the BUILD.BAT (type `build`) or MAK.BAT (type `mak`) batch files. For more information, refer to the instructions in this chapter under “How to Assemble WHello.”

NOTE:

Use TDW to trace WinApp's code as you read about its instructions. Assemble and link by typing `build`, start TDW, and use the `FileOpen` command to open WINAPP.EXE.

Overview of WinApp

Much of the WinApp program (refer to Listing 15.4) is similar to WHello, so I'll describe only significant differences here. Line 25 includes resource identifiers from WINAPP.RI. A typical Windows application has numerous resources, and it's usually best to declare the identifiers in a separate file as shown here.

Lines 29-52 declare more than a few Windows API functions, but except for the number of functions, this section is the same as in WHello. You may add any Windows function to this list, but if it grows much larger, you might want to store the declarations in a separate file. (*Hint:* Sort the file alphabetically so you can easily determine whether a function is already listed. The order of declarations is unimportant.)

Lines 56-66 declare the program's global procedures, and also make public its two callback functions, `WndProc` and `DlgProc`, so that Windows can call them. Because of the statements at lines 65-66, the linker definition file does not have to export the subroutine names. There's no harm in doing so, however, as shown in WINAPP.DEF at lines 9-10 (Listing 15.5).

The program's data segment (refer again to Listing 15.4) is similar to WHello's, but declares a few more variables that I'll explain later. The startup code is identical in both programs. As in WHello, `winMain` (lines 151-154) isn't required, but enables TDW's *Execute startup code* option to function correctly.

Window registration and display operations are the same in `WHello` and `WinApp`, but there is one significant difference. Lines 285-286 assign a menu resource, identified by `ID_MENU`, to the window class structure's `c1sLpszMenuName` variable. In English, `c1sLpsz` stands for “window class long pointer to a zero-terminated string.” To create a popup menu in a window, simply insert menu commands into the resource script file, and assign the menu's resource identifier to the window class structure.

NOTE:

There are other ways to activate popup menus in Windows programs, but assigning a resource identifier to the window class is the simplest. A good Windows tutorial should cover alternate methods, which are beyond the scope of this introductory chapter.

The message loop in `WinApp` (lines 219-236) is also identical to the same code in `WHello`. The two programs begin to differ, however, starting at line 313 in `WINAPP.ASM`, at the start of the main-window procedure, `WinProc`.

As in `WHello`, `WinProc` handles messages intended for the program's main window. In this case, the procedure uses register `di` to hold that window element's handle (line 317) and it uses `si` to hold the message value (line 318). Lines 319-327 inspect the message value in `si` and jump to the appropriate section of the window procedure that handles the message, or to a default handler. `WinProc` handles four messages:

- `WM_DESTROY` indicates that the window element is being destroyed, and because it is the program's main window, this message also terminates the program by calling `PostQuitMessage`. The code for this message is the same in `WHello` and `WinApp`.
- `WM_CLOSE` indicates that the user has attempted to close the window—by pressing `Alt+F4`, for example. The `WinApp` program uses this message to display a prompt that confirms the window's closure, providing the user a chance to continue the program rather than end it. (Similar programming can help prevent loss of information—for example, you could prompt the user to save an edited file before the program ends.)
- `WM_PAINT` indicates that the window's contents require drawing. Windows generates this message in response to a variety of events. For example, maximizing the window to full screen generates a `WM_PAINT` message, as does uncovering a window by moving another window aside.
- `WM_COMMAND` indicates that the user has selected a command from the window's popup menu. An additional subroutine in `WinApp` handles this program's commands—but more on that later.

To fully understand the sample program, you should examine and trace the code for each of these messages. The instructions at local label `@@WMCLOSE` handle the `WM_CLOSE` message; the code at `@@WMPAINT` handles `WM_PAINT`, and so on. The instructions at `@@RETURNZERO` set `ax:dx` to zero before returning from the window procedure. This is the correct finish for most messages, but you should confirm each message's requirements in a Windows API reference.

To display the message box that prompts you whether to terminate the program, `WndProc` calls the Windows `MessageBox` function at line 345. To this function you must pass a host of arguments as shown and commented by the preceding instructions at lines 339-344. The result is a message box dialog that operates on its own until closed by one of its buttons (see Figure 15.3).

Figure 15.3.
WinApp's message-box that prompts users whether to end the program.



When the window procedure receives a `WM_PAINT` message, it must respond by updating the window's contents. The first step in this process is to call the API `BeginPaint` function as demonstrated at lines 353-356. To this function you must pass the address of a paint structure, which in this case is a global variable in the data segment. (This section cannot be called recursively; therefore, a global variable is allowed.) `BeginPaint` fills the paint structure, `ps`, with values that you may use for displaying objects in the window by calling a Graphics Device Interface (GDI) function.

There's much more to GDI programming than I can cover in one chapter, so I'll show only one sample function call here. You call most GDI functions using similar techniques, however, and you can find additional examples in most Windows tutorials.

Usually, the first argument passed to a GDI function is a *device context handle* (HDC) obtained from `BeginPaint`. The handle identifies the *context* in which output is to occur. In most cases, that context is the video display that shows the window, but it could also represent another output device such as a plotter or printer.

`BeginPaint` stores the HDC in the paint structure, but for convenience, the function returns the same handle in register `ax`. Line 357 takes advantage of this fact by assigning `ax` to register `si`. Because the window procedure has already selected the message to process, `si` is again available for use—an optimization that few if any high-level languages would perform.

Most GDI functions require arguments such as coordinate values, strings, and other values. Lines 362-365, for example, push literal coordinates for a rectangle onto the stack. Finally, line 366 calls the GDI `Rectangle` function, which displays the rectangle shown in Figure 15.2.

The final step in processing a `WM_PAINT` message is to call `EndPaint`, which counters the earlier call to `BeginPaint`. Pass the window's handle and the address of the initialized paint structure, and then return `ax:dx` equal to zero (see lines 370-374).

Lines 378-383 handle the program's menu commands. Each command's programming could be inserted at this place, but for more modular and easier-to-maintain code, I prefer to call a local subroutine such as `WinAppCommands`. To that subroutine, `WndProc` passes the window handle, word, and long argument values by pushing these values onto the stack. (In the next section, I'll explain what `WinAppCommands` does.)

Finally, lines 388-393 call the default message handler, `DefWindowProc`, for messages not processed by the program's window procedure. This ensures that common operations such as window resizing, movements, popup menus, and so on work normally.

Menus

`WinApp`'s popup menu has only two commands—*File|Exit* (which ends the program) and *Help|About* (which displays an informational dialog box). Though relatively simple, the program demonstrates the basic steps for implementing menu commands far more complex than these.

First, design the menu as a resource script as lines 6-16 in `WINAPP.RC` show (refer back to Listing 15.6). Most development systems such as Borland's Resource Workshop supply a menu editor that writes resource script statements, but you can type the menu instructions into an `.RC` file manually as I did here.

After designing the menu, assign its resource identifier to the window class (lines 285-286 in `WINAPP.ASM`, Listing 15.4). Windows will then display the menu under the window's top border, and will issue a `WM_COMMAND` message to the window procedure when users select a menu command.

That message's `wp` parameter identifies which command was selected, and is set to the value in the menu resource for that command. For example, when you select `WinApp`'s *File|Exit* command, `wp` is set to that command's resource identifier value, `CM_DEMO_EXIT` (see line 13 in files `WINAPP.RH` and `WINAPP.RI`, and also line 10 in the resource script file, `WINAPP.RC`).

In response to `WM_COMMAND`, `WinApp`'s window procedure, `WndProc`, calls `WinAppCommands` (lines 468-499). In this subroutine, the code at lines 472-478 copies the window handle argument `hWnd` to register `di` and the command identifier to `si`. After these steps, lines 474-478 jump to an appropriate local label to process individual commands. For example, when you select *File|Exit*, line 475 jumps to the local label `@@CMDEMOEXIT`.

The instructions at that label (lines 482-489) demonstrate how to send a message to a window by calling `SendMessage` in the Windows API. In response to a command to exit the program, `WinApp` sends the window a `WM_CLOSE` message. This causes Windows to call the window procedure, which as you may recall, displays a message box that confirms your intention to quit.

`WinAppCommands` handles the program's other menu command by calling another subroutine, `HelpAbout` (lines 494-495). This subroutine displays the program's informational dialog, discussed in the next section.

NOTE

When using `WinApp` as a starting place for your own programs, you can enable the commented `jmp` at line 496 and add additional command instructions after this instruction.

Dialog Boxes

A dialog box is a specialized window that usually contains a variety of controls for selecting program options, displaying information, inputting data, and performing other interactive operations. Most Windows development systems come with a dialog editor such as the one in Borland's Resource Workshop that you can use to design dialog boxes.

The output of a dialog editor is a script of resource commands similar to those at lines 18-29 in `WINAPP.RC`, Listing 15.6. Few programmers would type these awkward instructions manually, so I won't explain them here. When it comes to dialogs, it's best to use an interactive editor that can create the necessary resource script statements.

As with all resources, a dialog is uniquely identified, in this example, by the symbol `ID_ABOUT`. The `HelpAbout` subroutine in `WINAPP.ASM` (see lines 511-534) uses this identifier to execute the dialog—a process that requires several critical steps.

The first of those steps creates a *procedure instance*, imaginatively called a *thunk*, which initializes the data segment register and then calls the program's code so the program can find its global data. The resulting indirect subroutine call makes a thinking noise that only programmers who also see leprechauns can hear.

The procedure instance for a dialog box is the subroutine that handles the dialog's messages. This resembles a window procedure (but is not exactly the same). In `WinApp`, subroutine `DlgProc` (lines 415-454) handles messages for the program's about-box dialog, shown in Figure 15.4.

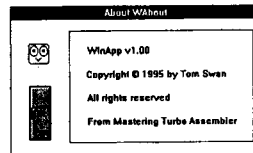
Figure 15.4.*WinApp's about-box dialog.*

After creating the dialog's procedure instance, the `HelpAbout` subroutine calls the Windows `DialogBox` function (lines 522-528). Except for the `ID_ABOUT` resource identifier at line 524 and for the name of the dialog procedure at lines 515-516, you may use the code in `HelpAbout` to activate most dialog boxes.

After `DialogBox` returns, you must free the procedure instance you created by calling `MakeProcInstance`. Lines 530-532 show the proper way to satisfy this requirement.

The Dialog Procedure

You program a dialog box's actions in a dialog procedure, similar to the way you program a window's actions in a window procedure. Like a window procedure, a dialog procedure receives messages intended for the dialog window.

A dialog procedure, however, differs significantly from a window procedure. You declare both kinds of subroutines using a `PROC` directive (line 415), and you specify the same types and numbers of arguments (line 416). But a dialog procedure returns a `BOOL` true or false value in `ax` rather than a 32-bit value returned by a window procedure in `ax:dx`. Also, a dialog procedure does not call a default message handler for unprocessed messages.

A dialog procedure must include programming for at least the messages shown in the sample listing (refer to lines 415-454). Windows sends the first message, `WM_INITDIALOG`, just before the dialog becomes active. You should use this opportunity to initialize any variables that the dialog requires. In this case, `WinApp`'s dialog has no variables, and as line 429 shows, the dialog procedure simply jumps to the section in the subroutine that returns a true value. Nevertheless, even if there are no initializations to perform, the dialog procedure must return true for the `WM_INITDIALOG` message. If for some reason the procedure cannot successfully initialize its variables, it should return false to cancel the dialog's activation.

The second required message is `WM_COMMAND`—the same message issued for menu commands. In this case, however, the message results from the selection of a dialog's buttons, from a command in the dialog's system menu if there is one, or from a keypress such as `Enter` or `Esc`.

As with menu commands, the `wp` parameter identifies which button or command was selected. One of those commands might be `IDOK`, which indicates that the user has elected to close the dialog by selecting an `OK` button or by pressing `Enter` if that button is the default.

Other dialogs might have many other buttons and commands, but all dialog procedures should include programming for `IDOK`.

The proper response to that command in this case is to call the Windows `EndDialog` function as shown at lines 441-444. To that function pass the dialog's window handle and any value to return to the dialog's caller. The `DialogBox` function returns this value in `ax` (set to zero in the sample code at line 443). You may use this value as you wish, though `WinApp` ignores it.

NOTE:

To add additional commands to a dialog box, enable the `jmp` instruction at line 445 and insert your programming afterward.

Summary

Writing Windows applications in assembly language requires a great deal of study and effort, but provides several advantages. With assembly language, you have total control over a program's startup and shutdown code, and you can use registers and memory to their best advantage. You can also eliminate excess baggage attached to Windows programs by high-level-language compilers.

This chapter introduces Windows programming techniques for Turbo Assembler's Ideal mode, but it is not a complete tutorial on Windows programming. To go beyond the information in this chapter, you'll need a Windows API reference, and you will also need files and utilities supplied with most C, C++, and other high-level-language development systems. Turbo Assembler does not provide all of the files and utilities you need to write Windows applications.

For easier programming, use the `MODEL` directive along with the `WINDOWS` and `PASCAL` options. These options automatically add prolog and epilog code to subroutines. Declare `EXTRN` all Windows API functions that your program calls.

You may define initialized (`DATASEG`) and uninitialized (`UDATASEG`) variables. You must reserve the first 16 bytes of initialized data for Windows' private use.

A window class is a structure that describes window characteristics. The first instance of a Windows application should register a window class. That and any subsequent program instances should create at least one window element of the class for use as the program's main window.

A window class also specifies a window procedure, to which Windows passes messages. Writing a window procedure is often called event-driven programming. A typical window procedure includes programming for many different kinds of messages that Windows generates in response to events. A program can also send its own messages. Unhandled messages should be passed to a default message handler, usually `DefWindowProc`.

Resources are binary data that the linker binds into the program's executable code file. Examples of resources in this chapter include menus, icons, and dialog boxes. Resources are typically created in a resource script file (or by using an interactive editor). A resource compiler converts the script to a binary file ending with the filename extension `.RES`. The linker binds this image into the final program. Turbo Assembler does not provide a resource compiler or editor.

A dialog procedure programs the actions for a dialog box. Like a window procedure, a dialog procedure responds to messages sent to the dialog window. A dialog procedure, however, returns a `BOOL` true or false value, and it does not call a default message handler for unprocessed messages.

Exercises

- 15.1. The Windows GDI function `Ellipse` draws an oval or circle. Show the declarations that enable an assembly language program to call the function.
- 15.2. The `GetWindowsDirectory` function obtains the path of the Windows directory, usually `C:\WINDOWS` on most computers. Parameter `lpszSysPath` addresses a string buffer where the function stores its results. Parameter `cbSysPath` equals the size in bytes of the string buffer, and should be at least 144. Show how to call this function in an assembly language program to obtain the Windows path. Also show any data declarations needed. `GetWindowsDirectory` is defined in C as follows:

```
UINT GetWindowsDirectory(LPSTR lpszSysPath, UINT cbSysPath);
```
- 15.3. Modify `WHello` to display its window maximized to full screen when the program is first executed.
- 15.4. Modify `WHello` to sound a beep when the user quits the program. You may use the following instructions—your job is to figure out where to insert them:

```
push 0
call MessageBeep
```
- 15.5. Modify `WinApp` to save its main-window handle in a global variable named `wMainHnd`.
- 15.6. *Advanced.* Modify `WinApp` to display its about-box dialog when the program is first started. *Hint:* One possible answer uses the modification from Exercise 15.5.

Projects

- 15.1. The `WHello` and `WinApp` demonstration programs in this chapter contain several duplicate sections—the `AppRun` message-loop and startup instructions, for example, are identical in both programs. Separate these sections into modules, and assemble them individually to create `.OBJ` code files for linking to Windows applications.
- 15.2. Set a breakpoint in TDW for the call to `DefWindowProc` at line 392 in `WINAPP.ASM`, and examine the message values in `si` to discover the kinds of standard messages that Windows processes. Try to match the message identifiers in `WINDOWS.INC`. Even better, write these messages to a text file—you have just created your own message tracing utility!
- 15.3. Write your own stub program to display a custom message if users attempt to execute your Windows programs from a DOS prompt. Your stub might display a copyright notice, and also give instructions for how to run Windows and start the application.
- 15.4. Modify `WinApp` to parse a command-line string of options. For example, to expand the program's window to full screen at startup, users could run `WinApp` with the Program Manager's *File|Run* command by entering `winapp -x`. To test your code, write a program that displays option strings passed to the program.
- 15.5. Modify `WinApp`'s about-box dialog to close automatically after a specified length of time (say, three seconds or so). *Hints:* Use the Windows function `GetTickCount` as a timer—look up its specifications in an API reference. One way to close the dialog window is to send it a `WM_COMMAND` message with a word parameter equal to `IDOK`, which simulates the selection of the dialog's OK button.

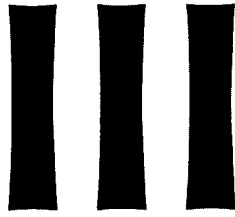

Reference

-

1000

1000

1000

1000

16

CHAPTER

Assembly Language Reference Guide

- About the Reference, 704
- Protected-Mode Instructions, 704
- Going to the Source, 704
- Instruction Timings and Binary Encodings, 705
- How to Use the Reference, 706

About the Reference

This chapter lists all 8086, 8088, 80286, 80386, 80486, and Pentium non-protected-mode mnemonics in alphabetic order, showing the affected flags, listing the syntax for all instruction forms, and giving examples and descriptions that explain how the instructions work. The material here supplements the information in the preceding chapters; therefore, to get the most from this reference, you may also want to consult the Subject Index to locate more details about specific instructions. Read the next sections for hints on using this chapter and for the meanings of various terms.

Protected-Mode Instructions

Protected-mode 80286, 80386, 80486, and Pentium instructions are not included in this reference. These instructions are typically used only for writing operating system code that needs to juggle multiple processes apparently running at the same time but in fact executing in sequence. The protected-mode programming's main purpose is to switch among such processes rapidly enough to give the illusion of simultaneous execution.

Some people may criticize the omission of protected-mode instructions in this reference but, after much thought about the subject, I decided that to list the instructions without also including the necessary background material required to write multitasking operating system software would be nothing more than a waste of space. For application programming, protected-mode instructions are not needed. Even so, this book would be incomplete if it did not at least mention the protected-mode instruction set. (See Table 16.1.) For a list of books that contain more information about using these instructions and about writing multitasking operating systems, see the Bibliography.

NOTE

Special 80286, 80386, 80486, and Pentium non-protected-mode instructions such as `bound`, `enter`, `leave`, and the conditional `set` instructions are covered here in detail along with syntax descriptions for extended 32-bit registers. Also, instructions restricted to specific processors are clearly marked.

Going to the Source

At least five sources were used to confirm the instruction formats and flag settings in this chapter. When any of these references did not exactly agree (which was often the case), the documentation printed here was confirmed by experiment. This extensive cross-checking turned up a surprising number of mistakes in various Intel and Microsoft references. Naturally, all of these errors are corrected here.

Table 16.1. Protected-Mode Instructions.

<i>Mnemonic</i>	<i>Description</i>
arpl	Adjust RPL Field of Selector
clts	Clear Task-Switched Flag in CRO
lar	Load Access Rights Byte
lgdt	Load Global Descriptor Table Register
lidt	Load Interrupt Descriptor Table Register
lldt	Load Local Descriptor Table Register
lmsw	Load Machine Status Word
lsl	Load Segment Limit
ltr	Load Task Register
mov (386)	Move To/From Special Registers*
sgdt	Store Global Descriptor Table Register
sidt	Store Interrupt Descriptor Table Register
sldt	Store Local Descriptor Table Register
smsw	Store Machine Status Word
str	Store Task Register
verr	Verify Segment for Reading
verw	Verify Segment for Writing

*80386, 80486, and Pentium only.

Instruction Timings and Binary Encodings

Because this book is primarily a practical guide to programming applications in assembly language, instruction timings and binary encodings for machine codes generated by the assembler are not listed. If you need to, you can find this data in the Intel references listed in the Bibliography.

The timing values, which many references blindly copy but which, I suspect, few programmers actually use, are omitted here for good reasons. Formulas that calculate theoretical timings for specific instructions tend to be inaccurate in practice. Factors such as the on-chip instruction cache, which preloads a certain amount of machine code for faster execution, plus the existence of multiple interrupt signals and memory wait states in real-life computer systems are likely to throw monkey wrenches into even the most carefully constructed timing formulas. A stopwatch and a good profiler will do you more good than hours spent calculating instruction loop timings. In general, your programs will run as fast as possible if you simply adhere to a few suggestions for selecting among various instruction formats:

- Instructions that refer to the accumulator—`al`, `ax`, or `eax` (80386 and later processors only)—may run faster than all other forms. (The instructions may also occupy fewer bytes of machine code.) Because of this, any such instructions are always listed first in this chapter's *Syntax/Example* sections. For instance, see the first two lines of the syntax for `adc` plus the first line of the 80386/486 syntax forms.
- Instructions that use only registers for all operands usually run faster than when these same instructions refer to data stored in memory. This is especially so when an 8086 instruction refers to data located at odd addresses because the 8086 can load data from even addresses a tiny bit more quickly. In other words, if you have a choice between using a register and a memory variable, use the register—your program may run faster.
- Arithmetic instructions `imul`, `mul`, `div`, and `idiv` are notoriously slow. Always use shifts and rotates to multiply and divide by powers of 2 or use a math coprocessor if possible.

Binary-machine-code formats for instructions are also not listed. In fact, the complicated bit formats and binary operation codes for individual instructions are rarely mentioned anywhere in this book. After all, one reason for using an assembler is to avoid having to worry about such details. On the very rare occasion that you need to know the exact bits generated for a specific instruction, you can just as easily write a test program and examine the assembled code with Turbo Debugger.

That about sums up what's not here. Now, let's take a look at what the reference does contain.

How To Use the Reference

The reference that follows describes each mnemonic separately except for conditional jump and set (80386/486 only) instructions, which are listed in tables for easier lookup. (See entries for *j-condition* and *set-condition*.) A few mnemonics that generate the same machine codes such as `cmps`, `cmpsb`, `cmpsw`, and `cmpsd` are listed together, but only when this does not disrupt the reference's alphabetic order. For example, `sa1` and `sh1` are listed separately, even though these two mnemonics represent the identical instruction.

The data for each mnemonic are divided into sections, each with a specific purpose. The divisions are:

- *Header*—Lists the mnemonic, name, processors on which the instruction is available, and effects on flag settings.
- *Purpose*—Gives a brief description of the instruction. Read these parts for quick reference and while browsing.
- *Syntax/Example*—Shows the various forms that the instruction may take and lists allowable register and memory operands. This section also shows a typical program example for each instruction form. When the instruction is available on multiple processors, any unique syntax forms for 80286, 80386, and later processors are listed separately.

- *Sample Code*—Places the instruction in a brief programming sample, giving a practical example of the way this instruction might be used in a typical program.
- *Description*—Fully explains how the instruction operates and frequently refers to the Sample Code section to explain further how to apply the instruction. Also, any unusual uses of flags and register assignments are described here.
- *See Also*—Refers to other instructions related in some way to this one.

More About the Headers

As a sample of the reference headers, Figure 16.1 duplicates the header for the `and` instruction. The mnemonic `and` is listed in lowercase, telling you exactly how to spell the instruction in a program. The name of the instruction is printed directly across from the mnemonic. Under these two items is a list of processors and flags. The 80186 processor, which is not used in any PC computers, is not listed here. The functionally equivalent 8086 and 8088 processors are listed jointly as 8086/88. The column marked 80386/486 refers to the 80386, 80486, Pentium, and (cross your fingers) to future compatible processors. Six new instructions added to this revised edition—`bswap`, `cmpxchg`, `invd`, `invlpg`, `wbinvd`, and `xadd`—require an 80486 or later-model processor. The filled-in triangles under the processor numbers indicate which processors support this instruction. In this sample, the header indicates that `and` is available on all four processors.

The flags are listed to the right of the processor numbers. (See Figure 16.1.) Under each flag are one or more symbols that indicate how this instruction affects the flag bits. A digit 0 or 1 indicates that the instruction resets or sets the flag to this value. A lowercase *u* indicates that, after the instruction executes, the value of this flag is undefined. A dash (–) indicates that the instruction does not change the setting of this flag. A filled-in triangle (▲) tells you that the flag value is subject to change according to the rules listed in Table 16.2. When other rules and conditions apply or, in a few cases where more than one symbol is listed (see `sal`, for example), the flag settings are discussed in the instruction's *Description*.

and				Logical AND																
Processor:	8086/88	80286	80386/486	Flags:	of	df	if	tf	sf	zf	af	pf	cf							
	▲	▲	▲		0	–	–	–	▲	▲	u	▲	0							

Figure 16.1.
A sample reference header.

More About the Syntax/Example Sections

Table 16.3 lists the symbols used in the *Syntax/Example* sections. Along with this table, the syntax references tell you exactly what forms of each instruction are allowed. For example, one of the syntax and example lines for `shl` is:

```
shl regW| memW, cl          shl [aword + bx], cl
```

Table 16.2. Standard Flag Usage.

<i>Flag</i>	<i>Name</i>	<i>Set to 1 if..., else reset to 0</i>
of	Overflow	Positive value is too large, or negative value is too small
sf	Sign	MSD of value = 1
zf	Zero	Full-width result = 0
af	Auxiliary	Carry out of or borrow to four LSDs of a1 occurred
pf	Parity	Eight LSDs of result have an even number of ones (even parity)
cf	Carry	Carry out of or borrow to full-width result occurred

Table 16.3. Symbols Used in the Reference.

<i>Symbols</i>	<i>Meaning</i>
	Either or
&	And
[]	Items in brackets are optional
farTarget	Address reference in foreign segment
nearTarget	Address reference within current segment
shortTarget	Address reference within -128 to 127 bytes
imm6	A 6-bit value (esc instruction only)
immB	Any 8-bit immediate value
immW	Any 16-bit immediate value
immDW	Any 32-bit immediate value
memB	Any 8-bit-byte memory reference
memW	Any 16-bit-word memory reference
memDW	Any 32-bit-doubleword memory reference
memFW	Any 48-bit-farword memory reference
memQW	Any 64-bit-quadword memory reference
memALL	Any B, W, DW, FW, or QW memory reference
regB	Any 8-bit-byte general register
regW	Any 16-bit-word general register
regDW	Any 80386/486 32-bit-doubleword general register
no operands	Requires no operands

Table 16.3 reveals that this form of `shl` requires two operands: a word (16-bit) general-purpose register or a word memory reference and the register `cl`. The example to the right of the syntax shows how an instruction of this form might appear in a program. Remember that this example is only one of many possible combinations of registers and memory references.

NOTE

Unless otherwise mentioned, memory references include all addressing modes described in Chapter 5.

More About the Examples and Samples

All examples and sample code sections were assembled and tested directly from this text. You can be sure that every scrap of code listed here represents actual instructions as they might appear in programs for the sample code sections. To run the code, you'll need to insert the instructions into a copy of `EXESHELL.ASM` from Chapter 2. You'll also have to initialize the `ds` and `es` segment registers appropriately.

NOTE

If you do run any of the samples, be careful with instructions that read and write to hardware ports. Because of the system-dependent nature of instructions such as `in`, `out`, `ins`, and `outs`, the samples of these mnemonics may assemble but may not perform any useful function. They may even cause a system crash. Such samples are clearly marked with a comment warning you not to run the code.

aaa

ASCII Adjust After Addition

Processor: 8086/88 80286 80386/486 Flags: of df if tf sf zf af pf cf
 ▲ ▲ ▲ u - - - u u ▲ u ▲

<i>Purpose</i>	Adjusts numeric sum of two unpacked BCD digits to unpacked BCD format, which is easily converted to ASCII.	
<i>Syntax/Example</i>	<code>aaa no operands</code>	<code>aaa</code>
<i>Sample Code</i>	<code>mov ah, 07</code>	<code>; First digit = 07</code>
	<code>mov al, 08</code>	<code>; Second digit = 08</code>
	<code>add al, ah</code>	<code>; Sum in al = 0Fh (15 decimal)</code>
	<code>sub ah, ah</code>	<code>; Clear ah to 00</code>
	<code>aaa</code>	<code>; Adjust: ah = 01, al = 05</code>
	<code>or ax, 3030h</code>	<code>; Convert digits to ASCII</code>

Description After adding two unpacked BCD digits and storing the 8-bit result in `al`, `aaa` converts `al` back to unpacked BCD format. If the previous `add` generated a carry or if `al` is greater than 9, then `ah` is incremented, and both `cf` and `af` are set to 1; otherwise, `cf` and `af` are set to 0. The four MSDs (upper half) of `al` are always zeroed. As the example shows, after `aaa`, you can OR either or both `ah` and `al` with `030h` to convert the BCD result to ASCII.

See Also `aad`, `aam`, `aas`, `daa`, `das`

aad

ASCII Adjust Before Division

Processor:	8086/88	80286	80386/486	Flags:	of	df	if	tf	sf	zf	af	pf	cf
	▲	▲	▲		u	-	-	-	▲	▲	u	▲	u

Purpose Converts two unpacked BCD digits in `ax` to binary.

Syntax/Example `aad no operands aad`

Sample Code

```

mov ah, '7'      ; Set ah to ASCII '7'
mov al, '6'      ; Set al to ASCII '6'
and ax, 0F0Fh    ; Convert ASCII to BCD (ax = 0706h)
aad              ; Convert to binary (ax = 004Ch)

```

Description Assign two unpacked BCD values to `ah` (most significant digit) and `al` (least significant digit), then execute `aad` to convert the digits to a 16-bit binary value in `ax`. Despite the instruction's name, `aad` can be used at any time—it doesn't have to precede a division. The largest possible value that `aad` can convert is 0909, equal to hexadecimal 063h, or 99 in decimal. Consequently, after using `aad` on unpacked BCD values from 0000 to 0909, register `ah` always equals 0.

See Also `aaa`, `aam`, `aas`, `daa`, `das`

aam

ASCII Adjust After Multiplication

Processor:	8086/88	80286	80386/486	Flags:	of	df	if	tf	sf	zf	af	pf	cf
	▲	▲	▲		u	-	-	-	▲	▲	u	▲	u

Purpose Converts 16-bit binary values from 0 to 99 decimal in `ax` to unpacked BCD digits, which are easily converted to ASCII.

Syntax/Example `aam no operands aam`

Sample Code

```

mov ax, 04Ch     ; Set ax to 76 decimal
aam              ; Convert to BCD (ax = 0706h)
or ax, 3030h     ; Convert ax to ASCII (ax = 3736h)

```

Description Use `aam` to convert a value in `ax` less or equal to hexadecimal 063h (99 decimal) from binary to unpacked BCD format, with the most significant digit in `ah` and the least significant digit in

See Also

a1. This operation reverses what aad does. Despite aam's name, you do not have to precede the instruction with a multiplication.
aaa, aad, aas, daa, das

aas**ASCII Adjust After Subtraction**

Processor: 8086/88 80286 80386/486 Flags: of df if tf sf zf af pf cf
 ▲ ▲ ▲ u - - - u u ▲ u ▲

Purpose Adjusts numeric difference of two unpacked BCD digits to unpacked BCD format, which is easily converted to ASCII.

Syntax/Example aas *no operands* aas

Sample Code

```
mov ah, 01      ; Set ah to BCD 01
mov al, 04      ; Set al to BCD 04
mov bl, 07      ; Set bl to BCD 07
sub al, bl      ; al ← al - bl (14-7)
aas             ; Adjust to BCD (ax = 0007)
or ax, 3030h    ; Convert ax to ASCII (ax = 3037h)
```

Description Subtract two BCD digits, place the result in al, and execute aas to convert the numeric difference to BCD format, which can then be converted to ASCII. If the previous sub required a borrow, then aas also subtracts 1 from ah and sets af and cf to 1; otherwise, ah is unchanged, and the two flags are set to 0. The example subtracts 07 (in bl) from 0104 (14 decimal in unpacked BCD format in ax), giving the BCD answer in ax—0007.

See Also

aaa, aad, aam, daa, das

adc**Add With Carry**

Processor: 8086/88 80286 80386/486 Flags: of df if tf sf zf af pf cf
 ▲ ▲ ▲ ▲ - - - ▲ ▲ ▲ ▲ ▲

Purpose Adds bytes, words, and doublewords (80386/486 only) plus the current value (1 or 0) of the carry flag.

Syntax/Example

```
adc al, immB           adc al, 2
adc ax, immW           adc ax, 1024
adc regB | memB, immB  adc bl, 2
adc regW | memW, immW  adc [word bx], 1024
adc regW | memW, immB  adc cx, 2
adc regB | memB, regB   adc [byte bx], dl
adc regW | memW, regW   adc dx, bx
adc regB, regB | memB   adc bl, bh
adc regW, regW | memW   adc dx, [word bx]
```

80386/486 only

```
adc eax, immDW         adc eax, 65537
adc regDW | memDW, immDW adc edx, 65537
```

```

adc regDW| memDW, immB   adc [dword bx], 2
adc regDW| memDW, regDW  adc edx, ecx
adc regDW, regDW| memDW  adc ecx, [dword bx]

Sample Code
DATASEG
var dd 01FFFEh           ; 131070 decimal
CODESEG
mov ax, 5                 ; Value to add
mov bx, offset var       ; Address var
add [word bx], ax        ; Add Low-order word
adc [word bx + 2], 0      ; Add in carry (var = 131075)

Description
When adding multibyte or multiword values, use adc after the
initial add of the low-order values to add in possible carries to the
higher-order bytes and words. The example demonstrates how
this works, adding 5 to the doubleword value stored at label var.
The adc adds a possible carry generated by the initial add of the
low-order word and the immediate value 5.

See Also
add, sbb, sub

```

add

Add Without Carry

Processor: 8086/88 80286 80386/486 Flags: of df if tf sf zf af pf cf
▲ ▲ ▲ ▲ - - - ▲ ▲ ▲ ▲ ▲

Purpose Adds two byte, word, or doubleword (80386/486 only) operands.

Syntax/Example

```

add al, immB           add al, 2
add ax, immW           add ax, 1024
add regB| memB, immB   add bl, 2
add regW| memW, immW   add [word bx], 1024
add regW| memW, immB   add cx, 2
add regB| memB, regB   add [byte bx], dl
add regW| memW, regW   add dx, bx
add regB, regB| memB   add bl, bh
add regW, regW| memW   add dx, [word bx]

80386/486 only
add eax, immDW         add eax, 65537
add regDW| memDW, immDW add edx, 65537
add regDW| memDW, immB add [dword bx], 2
add regDW| memDW, regDW add edx, ecx
add regDW, regDW| memDW add ecx, [dword bx]

Sample Code
DATASEG
var dd 01FFFEh           ; 131070 decimal
CODESEG
mov ax, [word var]       ; Load ax:dx with
mov dx, [word var + 2]   ; doubleword value

```

bound

Check Array Index Against Bounds

Processor:	8086/88	80286	80386/486	Flags:	of	df	if	tf	sf	zf	af	pf	cf
		▲	▲		-	-	-	-	-	-	-	-	-

Purpose Verifies that an array index is within a specified range.

Syntax/Example `bound regW, memDW` `bound si, [word bx]`

80386/486 only

`bound regDW, memQW` `bound esi, [qword bx]`

Sample Code

```

DATASEG
LowBound DW 100
highBound DW 199
CODESEG
P286
mov si, 105           ; Load si with index value
bound si, [LowBound] ; Check if index is in bounds

```

Description Assign the index value to the first operand and the address of the index range values to the second operand. This structure must contain two words (or, optionally, two doublewords on the 80386/486) with the lower value first (at the lower address). If the value of the first operand is not within the numeric range of these two values, a type 5 interrupt is shared by the Print Screen function; therefore, you must trap and prevent Print Screen operations before using bound.

See Also `iret`

bsf

Bit Scan Forward

Processor:	8086/88	80286	80386/486	Flags:	of	df	if	tf	sf	zf	af	pf	cf
			▲		-	-	-	-	-	▲	-	-	-

Purpose Scans bits in LSD to MSD order.

Syntax/Example `bsf regW, regW | memW` `bsf cx, dx`
`bsf regDW, regDW | memDW` `bsf ecx, [dword var]`

Sample Code

```

P386
mov dx, 0800h           ; Set bit number 11 to 1
bsf cx, dx             ; Scan (cx = 000Bh)
jz short @@10          ; Skip shift if all bits = 0
shr dx, cl             ; Shift dx by cl (dx = 0001)
@@10:

```

Description The first operand to `bsf` holds the result of scanning the second operand from right to left (starting at bit 0). If all bits are 0, then `zf` is set to 1, and the first operand is unchanged. If a 1 bit is located, then `zf` is set to 0, and the first operand is set to the bit

number. The sample uses this value to shift a bit in dx into the LSD position.

See Also bsr

bsr

Bit Scan Reverse

Processor: 8086/88 80286 80386/486 Flags: of df if tf sf zf af pf cf

Purpose Scans bits in MSD to LSD order.

Syntax/Example bsr *regW*, *regW* | *memW* bsr cx, [word bx]
bsr *regDW*, *regDW* | *memDW* bsr ecx, edx

Sample Code

```
P386
mov dx, 0040h           ; Set bit number 6 to 1
bsr cx, dx             ; Scan (cx = 0006h)
jz short @@10          ; Skip shift if all bits = 0
shr dx, cl             ; Shift dx by cl (dx = 0001h)
@@10:
```

Description The first operand to bsr holds the result of scanning the second operand from left to right (starting at the MSD). If all bits are 0, then zf is set to 1, and the first operand is unchanged. If a 1 bit is located, then zf is set to 0, and the first operand is set to the bit number. The sample uses this value to shift a bit in dx into the LSD position.

See Also bsf

bswap

Byte Swap

Processor: 8086/88 80286 80386 80486 Flags: of df if tf sf zf af pf cf

Purpose Swaps bytes in a 32-bit register to convert values between little- and big-endian formats.

Syntax/Example bswap *regDW* bswap eax

Sample Code

```
P486
mov  eax, 0ABCD1234h   ; Assign test value to eax
bswap eax              ; Swap bytes (eax = 3412CDAB)
bswap eax              ; Swap bytes (eax = ABCD1234)
```

Description Use this instruction on 80486 and later-model processors to convert data between little- and big-endian forms. Intel processors store data in little-endian form (least significant values at lower addresses). Motorola processors store data in big-endian form (least significant values at higher addresses). You can use bswap to convert data files for computer systems based on these processors such as PCs and Macintoshes.

As the Sample Code demonstrates, the instruction operates as a toggle. You can use `bswap` to convert data without having to determine the data's current format.

Be sure to specify a 32-bit register for this instruction. If you specify a 16-bit register, the results are undefined.

See Also `xchg`

bt

Bit Test

Processor: 8086/88 80286 80386/486 Flags: of df if tf sf zf af pf cf



- - - - - ▲

Purpose Copies a bit to the carry flag.

Syntax/Example `bt regW | memW, immB` `bt ax, 14`
`bt regW | memW, regW` `bt [word var], cx`
`bt regDW | memDW, immB` `bt eax, 8`
`bt regDW | memDW, regDW` `bt [dword var], ecx`

Sample Code

```
P386
mov dx, 0200h           ; Assign a test value to dx
bt dx, 9               ; Copy bit number 9 to cf
jc @@10                ; Test cf
call procedure         ; Call procedure if bit 9 = 0
@@10:
```

Description The first operand to `bt` must be a word or doubleword register or memory reference. The second operand may be a word (0–15) or doubleword (0–31) register or immediate value. Executing `bt` copies the bit from the first operand at the position specified by the second operand to `cf`. You can then use `jc` or `jnc` to test whether this bit was 1 or 0.

See Also `btc`, `btr`, `bts`, `test`

btc

Bit Test and Complement

Processor: 8086/88 80286 80386/486 Flags: of df if tf sf zf af pf cf



- - - - - ▲

Purpose Copies a bit to the carry flag and then complements the bit in the original value.

Syntax/Example `btc regW | memW, immB` `btc ax, 14`
`btc regW | memW, regW` `btc [word var], cx`
`btc regDW | memDW, immB` `btc eax, 8`
`btc regDW | memDW, regDW` `btc [dword var], ecx`

Sample Code P386
 mov dx, 0ABCDh ; Assign test value to dx
 mov cx, 14 ; Assign bit number to cx
 bts dx, cx ; Copy bit to cf and set

Description The operands and actions of bts are identical to bt, but after copying the specified bit to cf, that bit is set to 1 in the original value. In the sample, this changes dx to 0EBCDh.

See Also bt, btc, btr, test

call

Call Procedure

Processor:	8086/88	80286	80386/486	Flags:	of	df	if	tf	sf	zf	af	pf	cf
	▲	▲	▲		-	-	-	-	-	-	-	-	-

Purpose Calls a subroutine procedure.

Syntax/Example

call <i>nearTarget</i>	call Here
call <i>farTarget</i>	call far ptr There
call <i>regW</i>	call bx
call <i>memW</i>	call [word bx]
call <i>memDW</i>	call [dword bx]

80386/486 only

call <i>reg DW</i>	call eax
call <i>memFW</i>	call [fword si]

Sample Code

```
call Times2 ; Call subroutine
jmp Exit ; Exit program

PROC Times2 ; Subroutine
  add ax, ax ; Add doubleword in
  adc dx, dx ; ax:dx to itself
  ret ; Return from subroutine
ENDP
```

Description The call instruction pushes the address of the next instruction onto the stack and then jumps to the target location, causing the instructions in the subroutine procedure to begin executing. Usually, a ret instruction ends the subroutine, popping the return address from the stack and continuing the program with the instruction that follows the original call. In most programs, the target will be a label, marking the first instruction of the subroutine. But the target may also be a memory reference or a 16-bit register that holds the address of the subroutine. The sample calls a small subroutine Times2, which adds the value in ax:dx to itself. The ret instruction causes the program to continue from jmp Exit.

See Also ret

cbw

Convert Byte to Word

Processor:	8086/88	80286	80386/486	Flags:	of	df	if	tf	sf	zf	af	pf	cf
	▲	▲	▲		-	-	-	-	-	-	-	-	-

Purpose Extends a signed byte to a signed word.

Syntax/Example `cbw no operands cbw`

Sample Code `mov al, -1 ; Set al to -1`
`cbw ; Extend al to ax (ax = -1)`

Description Use `cbw` to extend an 8-bit signed value in `al` to a 16-bit signed value of the same magnitude in `ax`. The instruction works by copying the MSD of `al` to all bits in `ah`, thus setting `ah` to `0FFh` if `al` was negative (MSD = 1) or setting `ah` to `00h` if `al` was positive (MSD = 0).

See Also `cdq`, `cwd`, `cwde`

cdq

Convert Doubleword to Quadword

Processor:	8086/88	80286	80386/486	Flags:	of	df	if	tf	sf	zf	af	pf	cf
			▲		-	-	-	-	-	-	-	-	-

Purpose Extends a signed doubleword to a signed quadword.

Syntax/Example `cdq no operands cdq`

Sample Code `P386`
`mov eax, -1 ; Set eax to -1`
`cdq ; Extend eax to eax:edx (eax:edx = -1)`

Description Use `cdq` to extend a 32-bit signed value in `eax` to a 64-bit signed value of the same magnitude in the register pair `eax:edx`. The instruction works by copying the MSD of `eax` to all bits in `edx`, thus setting `edx` to `0FFFFFFFFh` if `eax` was negative (MSD = 1) or setting `edx` to 0 if `eax` was positive (MSD = 0).

See Also `cbw`, `cwd`, `cwde`

clc

Clear Carry Flag

Processor:	8086/88	80286	80386/486	Flags:	of	df	if	tf	sf	zf	af	pf	cf
	▲	▲	▲		-	-	-	-	-	-	-	-	0

Purpose Sets carry flag to 0.

Syntax/Example `clc no operands clc`

Sample Code `PROC AnyProc`
`; Procedure code`
`@@ErrExit:`

```

    stc          ; Set Carry (error)
    ret          ; Return to caller
@@NoErrExit:
    clc          ; Clear carry (no error)
    ret          ; Return to caller
ENDP AnyProc

```

Description Executing `clc` resets the carry flag to 0. As the sample code demonstrates, the instruction is often used to pass an error flag back from a subroutine, clearing `cf` if no error was detected.

See Also `cmc`, `stc`

cld

Clear Direction Flag

Processor:	8086/88	80286	80386/486	Flags:	of	df	if	tf	sf	zf	af	pf	cf
	▲	▲	▲		-	0	-	-	-	-	-	-	-

Purpose Clears direction flag to 0.

Syntax/Example `cld no operands` `cld`

Sample Code

```

DATASEG
s1 db 'Copy me' ; Source string
s2 db 80 dup (?) ; Destination string
CODESEG ; Note: assume es = ds
mov cx, 4 ; Assign count to cx
mov si, offset s1 ; Address source with ds:si
mov di, offset s2 ; Address destination with es:di
cld ; Auto-increment si and di
rep movsb ; Copy 4 chars from source to destination

```

Description Use `cld` to reset the direction flag to 0. Always execute `cld` before a repeated string operation, which increments either or both `si` and `di` automatically if `df = 0`. The sample uses `cld` to prepare for a repeated `movsb` string instruction, copying 4 characters from string `s1` to `s2`.

See Also `std`

cli

Clear Interrupt Flag

Processor:	8086/88	80286	80386/486	Flags:	of	df	if	tf	sf	zf	af	pf	cf
	▲	▲	▲		-	-	0	-	-	-	-	-	-

Purpose Clears the interrupt-enable flag to 0.

Syntax/Example `cli no operands` `cli`

Sample Code

```

sti ; Enable interrupts
hlt ; Wait for interrupt to occur
cli ; Disable interrupts

```

Description Executing `cld` disables maskable interrupts from being recognized. To ensure proper PC operations, interrupts should not be disabled for long periods. The sample suggests one way to synchronize a program with an external event, pausing with `hlt` until an interrupt occurs and then immediately disabling interrupts.

See Also `sti`

cmc

Complement Carry Flag

Processor:	8086/88	80286	80386/486	Flags:	of	df	if	tf	sf	zf	af	pf	cf
	▲	▲	▲		-	-	-	-	-	-	-	-	▲

Purpose Complements (toggles) the carry flag.

Syntax/Example `cmc no operands cmc`

Sample Code

```
PROC AnyProc
; Procedure code
@@Exit:
    cmc          ; Complement error flag
    ret          ; Return to caller
ENDP
```

Description Use `cmc` to complement the carry flag, changing `cf` to 0 if it was 1 or to 1 if it was 0. One use for `cmc` is in a procedure that returns `cf` as an error flag, but because of other operations leaving `cf` in the opposite state, must toggle the carry flag before returning.

See Also `cld`, `stc`

cmp

Compare

Processor:	8086/88	80286	80386/486	Flags:	of	df	if	tf	sf	zf	af	pf	cf
	▲	▲	▲		▲	-	-	-	▲	▲	▲	▲	▲

Purpose Compares two operands.

Syntax/Example

<code>cmp al, immB</code>	<code>cmp al, 2</code>
<code>cmp ax, immW</code>	<code>cmp ax, 1024</code>
<code>cmp regB memB, immB</code>	<code>cmp bl, 2</code>
<code>cmp regW memW, immW</code>	<code>cmp [word bx], 1024</code>
<code>cmp regW memW, immB</code>	<code>cmp cx, 2</code>
<code>cmp regB memB, regB</code>	<code>cmp [byte bx], dl</code>
<code>cmp regW memW, regW</code>	<code>cmp dx, bx</code>
<code>cmp regB, regB memB</code>	<code>cmp bl, bh</code>
<code>cmp regW, regW memW</code>	<code>cmp dx, [word bx]</code>

80386/486 only

<code>cmp eax, immDW</code>	<code>cmp eax, 65537</code>
<code>cmp regDW memDW, immDW</code>	<code>cmp [dword si], 99123</code>
<code>cmp regDW memDW, immB</code>	<code>cmp [dword bx], 2</code>
<code>cmp regDW memDW, regDW</code>	<code>cmp edx, ecx</code>
<code>cmp regDW, regDW memDW</code>	<code>cmp ecx, [dword bx]</code>

Sample Code

```

cmp ax, cx                ; Compare ax and cx
je @@10                  ; Jump if ax = cx
inc ax                    ; Increment ax if ax <> cx
@@10:

```

Description Use `cmp` to compare any two byte, word, or doubleword (80386 only) values. Both operands may not be memory references. Normally, you'll follow a `cmp` with a conditional jump instruction, taking appropriate action based on the result of the comparison. The sample uses `cmp` to test if registers `ax` and `cx` hold the same value. If not, `ax` is incremented. The `cmp` instruction works by subtracting the second operand from the first, throwing out the result, but saving the flags, which can then be tested. Consequently, when using `cmp` to determine how one value differs from another, assign the operands in the same order as the expression you need. For example, if you want to know whether `ax < bx`, use `cmp ax, bx` followed by `j1`.

See Also `cmps`, `cmpxchg`, `sub`

cmps cmpsb cmpsd cmpsw Compare String

Processor:	8086/88	80286	80386/486	Flags:	of	df	if	tf	sf	zf	af	pf	cf
	▲	▲	▲		▲	-	-	-	▲	▲	▲	▲	▲

Purpose Compare strings of values.

Syntax/Example

<code>cmps [es:]memB, memB</code>	<code>cmps [byte dest], [byte source]</code>
<code>cmps [es:]memW, memW</code>	<code>cmps [word es:si], [word di]</code>
<code>cmpsb no operands</code>	<code>cmpsb</code>
<code>cmpsw no operands</code>	<code>cmpsw</code>

80386/486 only

<code>cmps [es:]memDW, memDW</code>	<code>cmps [dword dest], [dword source]</code>
<code>cmpsd no operands</code>	<code>cmpsd</code>

Sample Code

```

DATASEG
s1 db 'Woe is me'
s2 db 'Woe is you'
CODESEG
ASSUME es: DGROUP        ; Tell TASM where es points
mov si, offset s1        ; Address source string
mov di, offset s2        ; Address destination string
mov cx, 10                ; Assign count to cx
cld                       ; Auto-increment si, di
repe cmps [s1], [s2]     ; Find first mismatch
repe cmpsb                ; Note: same as above line

```

Description The string comparison instructions compare two values in memory. Prefacing the instructions with `repe` or `repne` and storing a count value in `cx` builds instructions that can compare sequences of values. The first operand is the *source* and must be addressed by `ds:si` unless a segment override is used as in `[es:label1]`. The second

operand is the *destination* and must be addressed by *es:di*. The instructions subtract *[source] - [destination]*, discarding the result and saving the flags—similar to the way *cmp* works. In addition, if *df = 0*, *si* and *di* are advanced by the number of bytes being compared. If *df = 1*, the index registers are decremented.

Use *cmps* if you want Turbo Assembler to verify that the operands are addressable by *ds:si* or *es:si* and by *es:di* and also when you need to apply an *es:* override to the source operand. Or use the other three shorthand mnemonics if you don't want to specify explicit operands—*cmpsb* for byte comparisons, *cmpsw* for word comparisons, and *cmpsd* (80386 only) for doubleword comparisons. No matter what form of the instruction you use, it is still your responsibility to load *si* and *di* with the correct addresses. (For example, the last two lines in the sample, which finds the first mismatched character in two strings, produce the identical code.)

See Also

ins, *insb*, *insd*, *insw*, *lods*, *lodsb*, *lods*, *lodsw*, *movs*, *movsb*, *movsd*, *movsw*, *outs*, *outsb*, *outsd*, *outsw*, *scas*, *scasb*, *scasd*, *scasw*, *stos*, *stosb*, *stosd*, *stosw*

cmpxchg

Compare and Exchange

Processor: 8086/88 80286 80386 80486 Flags: of df if tf sf zf af pf cf
 ▲ ▲ - - - ▲ ▲ ▲ ▲ ▲

Purpose	Compares and exchanges data between the accumulator and a destination, which can be a register or a memory reference.
Syntax/Example	<i>cmpxchg regB memB, regB</i> <i>cmpxchg bh, ah</i> <i>cmpxchg regW memW, regW</i> <i>cmpxchg bx, ax</i> <i>cmpxchg regDW memDW, regDW</i> <i>cmpxchg ebx, eax</i>
Sample Code	<pre>mov ebx, 12345678h ; Assign test value to ebx mov eax, 87654321h ; Assign test value to eax cmpxchg ebx, eax ; Moves ebx into eax cmpxchg ebx, eax ; Moves eax into ebx</pre>
Description	This two-part instruction, available only on 80486 and later-model processors, begins by performing a <i>cmp</i> on the accumulator and another register or value in a memory location. If the accumulator (<i>eax</i> in the Sample Code) differs in value from the destination (<i>ebx</i>), the destination value is loaded into the accumulator. If the accumulator and destination values are equal, the destination is loaded into the accumulator. Obviously, however, in that event the net effect is nil, although the transfer still occurs. Flags are set as for the <i>cmp</i> instruction. The <i>zf</i> flag is set to 1 if the source and destination values are equal; it is set to 0 if the two values are initially not equal. In other words, if <i>zf</i> is zero, the value in the accumulator was changed to the destination value.

See Also

cmp, *xchg*

cwd

Convert Word to Doubleword

Processor: 8086/88 80286 80386/486 Flags: of df if tf sf zf af pf cf
 ▲ ▲ ▲ - - - - - - - -

Purpose Extends a signed word to a signed doubleword.

Syntax/Example `cwd no operands cwd`

Sample Code `mov ax, -1 ; Set ax to -1`
 `cwd ; Extend ax to ax:dx (ax:dx = -1)`

Description Use `cwd` to extend a 16-bit signed value in `ax` to a 32-bit signed value of the same magnitude in the register pair `ax:dx`. The instruction works by copying the MSD of `ax` to all bits in `dx`, thus setting `dx` to `0FFFFh` if `ax` was negative (MSD = 1), or setting `dx` to 0 if `ax` was positive (MSD = 0).

See Also `cbw, cdq, cwde`

cwde

Convert Word to Extended Doubleword

Processor: 8086/88 80286 80386/486 Flags: of df if tf sf zf af pf cf
 ▲ - - - - - - -

Purpose Extends a signed word to a signed extended doubleword.

Syntax/Example `cwde no operands cwde`

Sample Code `mov ax, -1 ; Set ax to -1`
 `cwde ; Extend ax to eax (eax = -1)`

Description Use `cwde` to extend a 16-bit signed value in `ax` to a 32-bit signed value of the same magnitude in `eax`. The instruction works by copying the MSD of `ax` to all bits in the high word of `eax`, thus setting the high word to `0FFFFh` if `ax` was negative (MSD = 1), or setting the high word to 0 if `ax` was positive (MSD = 0).

See Also `cbw, cdq, cwd`

daa

Decimal Adjust After Addition

Processor: 8086/88 80286 80386/486 Flags: of df if tf sf zf af pf cf
 ▲ ▲ ▲ u - - - ▲ ▲ ▲ ▲ ▲

Purpose Adjusts numeric sum of two packed BCD digits to packed BCD format.

Syntax/Example `daa no operands daa`

Sample Code `mov al, 053h ; Pack 5 and 3 into al`
 `mov bl, 018h ; Pack 1 and 8 into bl`
 `add al, bl ; al ← al + bl (al = 06Bh)`
 `daa ; Adjust result (al = 071h)`

Description After adding two packed 8-bit bytes and placing the result in *al*, execute *daa* to convert the binary sum back to packed BCD format. If both *af* and *cf* equal 1, then the sum was greater than 99 decimal. (You can use this information to generate a carry in a multidigit addition.) If *af* = 1 but *cf* = 0, then the sum of the lower two digits was greater than 9 and a carry is automatically taken into account for the high digit of the result. (You can normally ignore this condition.) If both *af* and *cf* are 0, then no carries were generated (and *daa* does not change the value in *al*).

See Also *aaa, aad, aam, aas, das*

das

Decimal Adjust After Subtraction

Processor:	8086/88	80286	80386/486	Flags:	of	df	if	tf	sf	zf	af	pf	cf
	▲	▲	▲		u	-	-	-	▲	▲	▲	▲	▲

Purpose Adjusts numeric difference of two packed BCD digits to packed BCD format.

Syntax/Example *das no operands das*

Sample Code

```

mov al, 007h    ; Pack 0 and 7 into al
mov bl, 014h    ; Pack 1 and 4 into bl
sub al, bl      ; al <- al - bl (al = 0F3h)
das             ; Adjust result (al = 093h)

```

Description After subtracting two packed BCD values, place the result in *al* and execute *das* to convert the result back to packed BCD format. If both *cf* and *af* equal 0, then no borrows were needed during the subtraction. If *cf* = 0 and *af* = 1, then a borrow was needed for the lower 2 digits and the result is adjusted accordingly. (You can normally ignore this condition.) If *cf* = 1, then the result is a negative decimal complement and you can subtract 100 from the result in *al* to find the absolute value. In other words, if *cf* = 1 and *al* = 93h, as in the sample, the corrected value is -7, or (93 - 100).

See Also *aaa, aad, aam, aas, daa*

dec

Decrement

Processor:	8086/88	80286	80386/486	Flags:	of	df	if	tf	sf	zf	af	pf	cf
	▲	▲	▲		▲	-	-	-	▲	▲	▲	▲	-

Purpose Subtract 1 from a register or variable.

Syntax/Example *dec regB | memB dec c1*
dec regW | memW dec [word var]

80386/486 only

dec regDW | memDW dec edx

Sample Code

```

mov cx, 100      ; Assign count to cx
@@10:
call AnyProc    ; Call a procedure
dec cx          ; Subtract 1 from count
jnz @@10       ; Jump if cx > 0

```

Description Use `dec` to decrease a byte, word, or doubleword (80386 only) register or memory value by 1. This is similar to subtracting 1 from unsigned values with `sub`, but faster. The sample demonstrates one way to construct a loop, calling `AnyProc` (not shown) 100 times and continuing past `jnz` only after `dec` finally decrements `cx` to 0.

See Also `inc`

div

Unsigned Divide

Processor:	8086/88	80286	80386/486	Flags:	of	df	if	tf	sf	zf	af	pf	cf
	▲	▲	▲		u	-	-	-	u	u	u	u	u

Purpose Divides two unsigned values.

Syntax/Example

```

div regB | memB      div dl
div regW | memW      div [word var]

```

80386/486 only

```

div regDW | memDW   div [dword bx]

```

Sample Code

```

DATASEG
var dd 01FFFEh ; 131070 decimal
CODESEG
mov ax, [word var]      ; Load low word into ax
mov dx, [word var + 2] ; Load high word into dx
mov bx, 1024           ; Load divisor into bx
div bx                 ; ax <- 131070 / 1024 (ax = 127)

```

Description Use `div` to divide unsigned integer values. The operand refers to the divisor. The dividend registers are determined by the divisor size. Byte divisors are divided into `ax`, placing the quotient in `al` and the remainder in `ah`. Word divisors are divided into `dx:ax` (low-order word in `ax`), placing the quotient in `ax` and the remainder in `dx`. Doubleword divisors (80386 only) are divided into `edx:eax` (low-order doubleword in `eax`), placing the quotient in `eax` and the remainder in `edx`.

If the result of the division is greater than the maximum value the designated quotient register can hold—or if the divisor equals 0—then a type 0 interrupt is generated. Unless steps are taken to trap this interrupt, DOS will halt the program and display a divide error message. This is further complicated by the fact that, for 8086/88 processors, the interrupt return address is

for the instruction following `div`, but, for 80286 and 80386 processors, the interrupt return address points to the `div` that caused the fault.

See Also `idiv`

enter

Enter Procedure

Processor:	8086/88	80286	80386/486	Flags:	of	df	if	tf	sf	zf	af	pf	cf
		▲	▲		-	-	-	-	-	-	-	-	-

Purpose Creates a stack frame for a procedure's local variables.

Syntax/Example

```
enter immW,0      enter 2,0
enter immW,1      enter 8,1
enter immW, immB  enter 0,3
```

Sample Code

```
PROC AnyProc
    enter 8,0      ; Reserve 8 bytes for local variables
    ; Procedure code
    leave         ; Reclaim reserved stack space
    ret          ; Return to caller
ENDP AnyProc
```

Description Mostly used by high-level languages, `enter` prepares `bp` and subtracts from `sp` the number of bytes specified by the first operand, reserving space for variables on the stack, which can then be addressed by `ss:bp`. The second operand equals the nesting level and can be either an immediate 0 or 1 for fastest operation or a higher immediate value. The level is used by languages such as Pascal that allow true procedure nesting, providing a method for inner procedures to access local variables declared on outer levels. The sample shows how to use `enter` to reserve 8 bytes of stack space for variables. To recover this space, execute `leave` just before `ret`.

See Also `leave`, `ret`

esc

Escape

Processor:	8086/88	80286	80386/486	Flags:	of	df	if	tf	sf	zf	af	pf	cf
	▲	▲	▲		-	-	-	-	-	-	-	-	-

Purpose Passes instructions to a coprocessor.

Syntax/Example

```
esc imm6, regB | regW  esc 5, ax
esc imm6, memAll      esc 5, [var]
```

Sample Code

```
fild st(0)          ; Push operand
wait                ; Wait required for
esc 8, ax           ; 8087
```

Description You can use `esc` to pass instructions to a coprocessor. The first operand represents the instruction's operation code. The second operand specifies a destination or source value for the coprocessor instruction. Because Turbo Assembler recognizes math coprocessor instruction mnemonics, `esc` is rarely of much practical use. If you do use `esc`, be aware that the 8087 requires a `wait` instruction before every math coprocessor instruction. Turbo Assembler automatically inserts `wait`s as needed—another reason to use coprocessor mnemonics instead of `esc`.

See Also `wait`

hlt

Halt

Processor:	8086/88	80286	80386/486	Flags:	of	df	if	tf	sf	zf	af	pf	cf
	▲	▲	▲		-	-	-	-	-	-	-	-	-

Purpose Halts until interrupt or reset.

Syntax/Example `hlt no operands` `hlt`

Sample Code

```
cli                ; Disable maskable interrupts
hlt                ; Pause until NMI or reset
sti                ; Enable maskable interrupts
```

Description Execute `hlt` to pause until the next interrupt signal is acknowledged or until a reset signal is received. If maskable interrupts are disabled, `hlt` pauses the program until a reset signal or until a nonmaskable interrupt is acknowledged.

See Also `cli`, `sti`

idiv

Signed Integer Divide

Processor:	8086/88	80286	80386/486	Flags:	of	df	if	tf	sf	zf	af	pf	cf
	▲	▲	▲		u	-	-	-	u	u	u	u	u

Purpose Divides two signed values.

Syntax/Example `idiv regB | memB` `idiv dI`
`idiv regW | memW` `idiv [word var]`

80386/486 only

Sample Code

```
idiv regDW | memDW    idiv [dword bx]
mov ax, 100           ; Assign dividend to ax
mov bl, -3            ; Assign divisor to bl
idiv bl               ; al <- ax / bl (remainder in ah)
neg al                ; Find absolute value of al
```

Description Use *idiv* to divide signed integer values. The operand refers to the divisor. The dividend registers are determined by the divisor size. Byte divisors are divided into *ax*, placing the quotient in *al* and the remainder in *ah*. Word divisors are divided into *dx:ax* (low-order word in *ax*), placing the quotient in *ax* and the remainder in *dx*. Doubleword divisors (80386/486 only) are divided into *edx:eax* (low-order doubleword in *eax*), placing the quotient in *eax* and the remainder in *edx*. The remainder always has the same sign as the original dividend.

The sample divides 100 decimal by -3, placing the quotient in *al* (0DFh) and the remainder in *ah* (01). Remember that negative values like 0DFh are expressed in two's complement form. To find the absolute value (3 in this case), use *neg* as in the sample.

If the result of the division is greater than the maximum value the designed quotient register can hold—or if the divisor equals 0—then a type 0 interrupt is generated. Unless steps are taken to trap this interrupt, DOS will halt the program and display a divide error message. This is further complicated by the fact that, for 8086/88 processors, the interrupt return address points to the instruction following *div*, but for 80286 and 80386/486 processors, the interrupt return address points to the *div* that caused the fault.

See Also *div*

imul Signed Integer Multiply

Processor:	8086/88	80286	80386/486	Flags:	of	df	if	tf	sf	zf	af	pf	cf
	▲	▲	▲		▲	-	-	-	u	u	u	u	▲

Purpose Multiplies two signed values.
Syntax/Example *imul regB | memB* *imul [byte bx]*
imul regW | memW *imul cx*

80286, 80386/486 only
imul regW, immB *imul cx, 9*
imul regW, immW *imul bx, 451*
imul regW, regW | memW, immB *imul cx, [word bx], 3*
imul regW, regW | memW, immW *imul ax, bx, 300*

80386/486 only
imul regDW | memDW *imul [dword bx]*
imul regDW, immB *imul ebx, 10*
imul regDW, immDW *imul eax, 32769*
imul regW, regW | memW *imul bx, cx*
imul regDW, regDW | memDW *imul ecx, [dword\bx]*
imul regDW, regDW | memDW, immB *imul eax, edx, 12*
imul regDW, regDW | memDW, immDW *imul eax, [dword bx], 35790*

Sample Code

```

mov al, 4                ; Multiplicand
mov bl, -2               ; Multiplier
imul bl                 ; ax ← al * bl
                        ; (ax = 0FFF8h, cf = of = 0)

mov al, 127             ; Multiplicand
mov bl, -128            ; Multiplier
imul bl                 ; ax ← al * bl
                        ; (ax = 0C080h, cf = of = 1)

```

Description Depending on the processor, `imul` has three basic formats, taking from one to three operands. Some forms require explicit registers. The simplest form multiplies a byte register or variable by `al`, placing the result in `ax`. A similar form multiplies a word register or variable by `ax`, placing the result in `dx:ax` (low-order word in `ax`). On the 80386/486 only, `imul` can multiply `eax` by a doubleword register or variable, placing the result in `edx:eax`. With all these forms, if both `cf` and `of` equal 0 after `imul`, then the high-order portion of the result is merely the sign extension of the low-order portion. In other words, as the first part of the sample shows, multiplying `4 * -2` sets `ax` to `0FFF8h`. Because `cf` and `of` are 0, an `(0FFh)` extends the sign of the 8-bit answer in `al` (`0F8h`), creating a full 16-bit value. When `cf` and `of` are both set to 1, as in the second part of the sample, then the result occupies the full width of the destination register—in this case `ax`, which equals the two's complement value `0C080h`, or `-16,256` in decimal, the product of `127 * -128`.

80286 and 80386/486 processors expand on these basic forms with multiple-operand `imul` instructions. In the two-operand format, the first operand is the multiplicand; the second operand is the immediate byte or word multiplier. The product replaces the specified multiplicand register. In the three-operand format, the first operand specifies a destination register for the product, the second register holds the multiplicand, and the third operand is the immediate byte or word multiplier. The 80386/486 further expands these forms, allowing various combinations of doubleword registers, memory references, and immediate values. With all these variations, if `cf` and `of` are 0 after `imul`, then the product exactly fits within the specified destination register (always the first operand); otherwise, the produce is too large for this register.

See Also

`mul`

in

Input From Port

Processor:	8086/88	80286	80386/486	Flags:	of	df	if	tf	sf	zf	af	pf	cf
	▲	▲	▲		-	-	-	-	-	-	-	-	-

Purpose

Inputs values from ports.

Syntax/Example `in al, immB` `in al, 14h`
 `in al, dx` `in al, dx`
 `in ax, immB` `in ax, 01Fh`
 `in ax, dx` `in ax, dx`

80386 only:
 `in eax, immB` `in eax, 0Fh`
 `in eax, dx` `in eax, dx`

Sample Code `Ctrl8259 EQU 021h` ; 8259 masks port
 `in al, Ctrl8259` ; Read 8259 enable masks
 `and al, EnableIRQ` ; Clear masked bit
 `out Ctrl8259, al` ; Write new 8259 masks

Description The `in` instruction reads the value of a hardware port into `al`, `ax` or `eax` (80386/486 only). As the sample shows, `in` is often used in conjunction with `out` and logical instructions such as `and` and `or` to examine and change bit switches at various port addresses in the computer. The simplest form of `in` reads a byte value into `al` from an immediate port address in the range 0–255. To access higher port addresses, specify the address in the `dx` register.

See Also `ins`, `out`

inc

Increment

Processor:	8086/88	80286	80386/486	Flags:	of	df	if	tf	sf	zf	af	pf	cf
	▲	▲	▲		▲	-	-	-	▲	▲	▲	▲	-

Purpose Adds 1 to a register or variable.

Syntax/Example `inc regB | memB` `inc [byte bx]`
 `inc regW | memW` `inc dx`

80386/486 only
 `inc regDW | memDW` `inc ecx`

Sample Code `mov dx, 0` ; Initialize dx ← 0
 `@@@10:`
 `call AnyProc` ; Call a procedure
 `inc dx` ; dx ← dx + 1
 `cmp dx, 1000` ; Does dx = 1000?
 `jne @@@10` ; Jump if dx <> 1000

Description Use `inc` to increase a byte, word, or doubleword (80386/486 only) register or memory value by 1. This is similar to adding 1 to unsigned values with `add`, but faster. The sample uses `inc` to construct a simple loop, using `dx` as a control value to call a procedure `AnyProc` (not shown) 1000 times. (There may be more efficient ways to construct such a loop.)

See Also `dec`

ins insb insd insw

Input From Port To String

Processor:	8086/88	80286	80386/486	Flags:	of	df	if	tf	sf	zf	af	pf	cf
		▲	▲		-	-	-	-	-	-	-	-	-

Purpose Inputs values from ports to a sequence of bytes, words, or doublewords in memory.

Syntax/Example

<code>ins di memB, dx</code>	<code>rep ins [var], dx</code>
<code>ins di memW, dx</code>	<code>rep ins [word var], dx</code>
<code>insb no operands</code>	<code>rep insb</code>
<code>insw no operands</code>	<code>rep insw</code>

80386/486 only

<code>ins regDW memDW, dx</code>	<code>rep ins [dword var], dx</code>
<code>insd no operands</code>	<code>rep insd</code>

Sample Code ; ! NOTE: Don't run this sample!

```

mov cx, 100           ; Number of words to read
mov dx, 049h         ; Specify port address
mov di, offset s1    ; Address destination
cld                  ; Auto-increment di
rep insw             ; Load string from port

```

Description As with all string instructions, the register assignments for `ins` and its shorthand forms `insb`, `insd` (80386/486 only), and `insw` are fixed, even if you specify address labels explicitly. The destination register is always `es:di`, and the segment cannot be overridden. The port number must be placed in `dx`. (Don't forget to do this also for the shorthand mnemonics!) If `df = 0`, then `ins` increments `di`; if `df = 1`, `ins` decrements `di`. Normally, you'll preface `ins` with `rep`, repeating the instruction for the number of times specified in `cx` as illustrated in the sample.

See Also `cmpsb`, `cmpsd`, `cmpsw`, `lods`, `lodsb`, `lods`, `lodsd`, `lodsw`, `movs`, `movsb`, `movsd`, `movsw`, `outs`, `outsb`, `outsd`, `outsw`, `scas`, `scasb`, `scasd`, `scasw`, `stos`, `stosb`, `stosd`, `stosw`

int

Call Interrupt Service Routine

Processor:	8086/88	80286	80386/486	Flags:	of	df	if	tf	sf	zf	af	pf	cf
		▲	▲		-	-	0	0	-	-	-	-	-

Purpose Calls interrupt service routine by number.

Syntax/Example

<code>int 3</code>	<code>int 3</code>
<code>int immB</code>	<code>int 21h</code>

Sample Code

```

DATASEG
message db 'Mastering Turbo Assembler', '$'
CODESEG
mov dx, offset message ; Address message string
mov ah, 9               ; Specify DOS function number
int 21h                 ; Call DOS function handler
    
```

Description

Although there are two forms of `int`, they appear the same in programs. The first form is a special 1-byte code (0CC_h) that debuggers typically use to replace instructions at specified breakpoints. You can insert this code yourself to cause most debuggers (Turbo Debugger included) to halt at various locations. The second form specifies a byte value as the interrupt number, which can range from 0 to 255, representing one of 256 four-byte vector pointer addresses stored in memory beginning at address 0000:0000. Executing `int` runs the interrupt service routine at the vectored address for this interrupt number. Just before this, the processor pushes onto the stack the flags and the return address, which are restored in the interrupt service routine by executing `iret`. In addition, the interrupt and trap flags are set to 0. (These two flags are restored by `iret`, and, because the flags are changed only for the interrupt service routine, some 8086 references incorrectly indicate that `if` and `tf` are not changed by `int`.)

See Also `into`, `iret`

into

Interrupt On Overflow

Processor:	8086/88	80286	80386/486	Flags:	of	df	if	tf	sf	zf	af	pf	cf
	▲	▲	▲		-	-	▲	▲	-	-	-	-	-

Purpose Generates a type 4 interrupt if `of = 1`.

Syntax/Example `into` *no operands* `into`

Sample Code

```

P386
imul ecx, [dword bx] ; ecx <- ecx * [bx]
into                 ; Interrupt on overflow
    
```

Description

By installing an interrupt service routine for interrupt 4, you can use `into` to force execution of this code if the overflow flag is set by a previous operation. The instruction `into` behaves like `int`, pushing the flags and return address onto the stack, resetting `tf` and `if`, and jumping to the vector for interrupt 4. The interrupt code can then deal with the error and execute `iret` to resume program execution. The sample demonstrates how you might use `into` to detect an overflow from an `imul` instruction for an 80386 processor.

See Also `int`, `iret`

invd

Invalidate Cache

Processor: 8086/88 80286 80386 80486 Flags: of df if tf sf zf af pf cf

<i>Purpose</i>	Flushes the 80486 internal instruction cache, and also issues a special bus cycle that hardware designers can use as a command to flush any caches that are external to the processor.
<i>Syntax/Example</i>	invd <i>no operands</i> invd
<i>Sample Code</i>	P486 invd ; Flush cache and issue flush bus cycle
<i>Description</i>	Use this instruction only on 80486 processors. It requires no operands and it affects no flags. Intel states that invd is “implementation dependent,” meaning that future processors may implement the instruction differently. There are few if any good reasons for application-level programs to use this instruction.
<i>See Also</i>	invlpg, wbinvd

invlpg

Invalidate TLB Entry

Processor: 8086/88 80286 80386 80486 Flags: of df if tf sf zf af pf cf

<i>Purpose</i>	Invalidates an entry in the TLB, otherwise known as the “translation lookaside buffer.”
<i>Syntax/Example</i>	invlpg memAll invlpg table
<i>Sample Code</i>	(none: see Description)
<i>Description</i>	This instruction is valid only for 80486 processors, and Intel states that it may or may not be provided on future CPUs. The instruction is used to invalidate entries in the TLB, which translates linear and physical addresses. It should not be used in application programming.
<i>See Also</i>	invd, wbinvd

iret iretd

Interrupt Return

Processor: 8086/88 80286 80386/486 Flags: of df if tf sf zf af pf cf

<i>Purpose</i>	Returns from an interrupt service routine.
<i>Syntax/Example</i>	iret <i>no operands</i> iret
	80386/486 only
	iretd <i>no operands</i> iretd

Sample Code

```

PROC MyISR
  push ax          ; Save any changed registers
  sti             ; Enable maskable interrupts
  ; Procedure code
  iret            ; Return from interrupt
ENDP

```

Description Execute `iret` as the last instruction in an interrupt service routine (ISR). The instruction pops the return address `cs:ip` from the stack and the flags, continuing the program from the point of the interruption. Use the same `iret` whether the interrupt was generated externally or internally by a fault condition such as an illegal division or by the `int` and `into` instructions. On 80386/486-based systems only, `iretd` can be used to return to a 32-bit segment, popping the full-width `eip` extended instruction pointer from the stack.

See Also `int`, `into`

j-condition

Jump Conditionally

Processor:	8086/88	80286	80386/486	Flags:	of	df	if	tf	sf	zf	af	pf	cf
	▲	▲	▲		-	-	-	-	-	-	-	-	-

Purpose Jumps to a new location if certain flags are set and/or reset.

Syntax/Example `condition shortTarget jge @@30`

Sample Code

```

cmp ax, 1024      ; Compare ax and 1024
jb @@20          ; Jump if ax < 1024

```

Description All conditional jumps operate similarly and, therefore, are listed together here for easy reference. Also, although some of the mnemonics represent the same instructions (for example, `je` and `jz`), the mnemonics are listed separately. As Table 16.4 shows, certain flag settings control whether the jump is made. The target address of a conditional jump is a signed displacement of -128 to +127 bytes away from the address of the *following* instruction. On 80386 systems only, displacements may range from -32,768 to +32,767 bytes.

The sample demonstrates how to use a conditional jump after a `cmp` to test the value of a register. Comparing `ax` with 1,024 and following with `jb` jumps to the target address if the value of `ax` is *below* 1,024. Conditions that use the words "above" and "below" refer to unsigned comparisons; conditions that use the words "greater" and "less" refer to signed comparisons.

See Also `jmp`

Table 16.4. Conditional Jump Reference.

<i>Instruction</i>	<i>Jump if...</i>	<i>Flags</i>
ja	above	(cf = 0) & (zf = 0)
jae	above or equal	(cf = 0)
jb	below	(cf = 1)
jbe	below or equal	(cf = 1) (zf = 1)
jc	carry	(cf = 1)
jcxz	cx equals 0	–
jecxz	ecx equals 0	– (80386/486 only.)
je	equal	(zf = 1)
jg	greater	(sf = of) & (zf = 0)
jge	greater or equal	(sf = of)
jl	less	(sf <> of)
jle	less or equal	(sf <> of) (zf = 1)
jo	overflow	(of = 1)
jp	parity	(pf = 1)
jpe	parity even	(pf = 1)
jpo	parity odd	(pf = 0)
js	sign	(sf = 1)
jz	zero	(zf = 1)
jna	not above	(cf = 1) (zf = 1)
jnae	not above or equal	(cf = 1)
jnb	not below	(cf = 0)
jnb	not below or equal	(cf = 0) & (zf = 0)
jnc	not carry	(cf = 0)
jne	not equal	(zf = 0)
jng	not greater	(sf <> of) (zf = 1)
jnge	not greater or equal	(sf <> of)
jnl	not less	(sf = of)
jnle	not less or equal	(sf = of) & (zf = 0)
jno	not overflow	(of = 0)
jnp	not parity	(pf = 0)
jns	not sign	(sf = 0)
jnz	not zero	(zf = 0)

jmp**Jump Unconditionally**

Processor: 8086/88 80286 80386/486 Flags: of df if tf sf zf af pf cf

▲ ▲ ▲ - - - - - - - -

Purpose

Jumps to a new location.

Syntax/Example

```
jmp short Target      jmp short @@10
jmp near Target      jmp CloseBy
jmp far Target      jmp far OverThere
jmp regW | memW     jmp bx
jmp memDW          jmp [dword bx]
```

80386/486 only**Sample Code**

```
jmp regDW          jmp ecx
or bx, bx          ; Does bx = 0?
jnz Continue      ; Jump if bx <> 0
jmp Exit          ; Else jump to exit
Continue:
```

Description

The `jmp` instruction causes program execution to continue at the address specified as a displacement from the instruction *following* the `jmp`. In assembly language programs, Turbo Assembler calculates the displacement from a label that you specify as the operand, automatically using the most efficient form of the instruction possible. There's rarely any good reason to calculate displacements manually.

When jumping to higher addresses, use the `SHORT` operator as in `jmp SHORT Nearby`, or Turbo Assembler will insert wasteful `nop` instructions to allow for the possibility that the address later will prove to be farther than about 128 bytes away.

In place of an explicit label, you can specify the target address in a register or via a memory reference. The 80386/486 allows extended registers to hold 32-bit offset addresses. This powerful ability is especially useful in creating "jump tables," which contain lists of locations to which control passes based on certain conditions.

See Also

j-condition

lahf**Load Flags Into ah Register**

Processor: 8086/88 80286 80386/486 Flags: of df if tf sf zf af pf cf

▲ ▲ ▲ - - - - - - - -

Purpose

Copies `sf`, `zf`, `saf`, and `cf` to `ah`.

Syntax/Example

```
lahf no operands    lahf
```

Sample Code

```
lahf                ; Load flags in to ah
test ah, 0Dh        ; Test sf, zf, cf
jnz @@10           ; Jump if any flag = 1
```

Description Execute `lahf` to load the five flags `sf`(7), `zf`(6), `af`(4), `pf`(2), and `cf`(0) into lower 4 bits of register `ah`. Bit numbers are shown in parentheses. After executing `lahf`, other bits in `ah` are undefined and may also change.

See Also `sahf`

lds

Load Pointer and ds

Processor:	8086/88	80286	80386/486	Flags:	of	df	if	tf	sf	zf	af	pf	cf
	▲	▲	▲		-	-	-	-	-	-	-	-	-

Purpose Loads pointer from memory into a register and `ds`.

Syntax/Example `lds regW, memDW` `lds si, [bp + 4]`

Sample Code

```

80386/486 only
lds regDW, memFW      lds edi, [bx]
push cs                    ; Push segment
mov ax, offset var      ; Load offset
push ax                   ; Push offset
;
;
push bp                   ; Save bp
mov bp, sp               ; Address stack with bp
lds si, [bp + 2]         ; Load pointer to ds:si

```

Description Use `lds` to load both a 16-bit general-purpose register (usually `si`) and the `ds` segment register with a 32-bit pointer stored in memory. The `memDW` operand may be any of the usual addressing modes, except for a direct address, which is not permitted. The 80386/486 can load a 48-bit pointer into an extended 32-bit register plus `ds`. The sample demonstrates how to pick up a pointer, perhaps passed to a subroutine by address on the stack. The first part of the sample pushes the segment `cs` and offset values of a variable (not shown) onto the stack; the second part uses `lds` along with `bp` to load `ds:si` with the pointer value.

See Also `lea`, `les`, `lfs`, `lgs`, `lss`

lea

Load Effective Address

Processor:	8086/88	80286	80386/486	Flags:	of	df	if	tf	sf	zf	af	pf	cf
	▲	▲	▲		-	-	-	-	-	-	-	-	-

Purpose Loads offset address of memory reference into a register.

Syntax/Example `lea regW, memW` `lea bx, [bp + 2]`

80386/486 only

`lea regW | regDW, memW | memDW` `lea edi, [dword bp + 2]`

Sample Code

```

DATASEG
array db 80 dup (0)
CODESEG
lea  bx, [array + si]      ; Use this...
mov  bx, offset array     ; ...instead of these
add  bx, si                ; two lines
lea  bx, [array + bp + si] ; Use this...
mov  bx, offset array     ; ...instead of these
add  bx, bp                ; three lines
add  bx, si

```

Description Use `lea` to load the offset address, also called the effective address, into a word register or a doubleword register on 80386/486 systems. When you need to use a complex memory reference repeatedly—or when you need to load a register, usually `bx`, with the address of a table element perhaps for use with the `xlat` instruction—you can use `lea` to compute the offset address. The sample demonstrates how doing this can perform the work of two or three instructions. The first code line performs the same task as lines two and three; the fourth code line does the same job as the last three lines.

See Also `lds`, `les`, `lfs`, `lgs`, `lss`

leave

Leave Procedure

Processor: 8086/88 80286 80386/486 Flags: of df if tf sf zf af pf cf

Purpose Removes from the stack local variable space allocated by `enter`.

Syntax/Example `leave no operands` `leave`

Sample Code

```

PROC AnyProc
  enter 6,0      ; Reserve 6 bytes for local variables
  ; Procedure code
  leave         ; Reclaim reserved stack space
  ret          ; Return to caller
ENDP AnyProc

```

Description Just before a `ret` instruction, use `leave` to reclaim stack space previously allocated by `enter` at the start of a procedure. Usually, high-level language compilers use `leave` and `enter` to implement functions and procedures, but you can certainly use these instructions in pure assembly language programs, too. A `leave` performs the two steps `mov sp, bp` and `pop bp`, thus restoring the stack pointer and `bp`, which was pushed onto the stack by `enter`.

See Also `enter`, `ret`

les

Load Pointer and es

Processor:	8086/88	80286	80386/486	Flags:	of	df	if	tf	sf	zf	af	pf	cf
	▲	▲	▲		-	-	-	-	-	-	-	-	-

Purpose Loads pointer from memory into a register and es.

Syntax/Example `les regW, memDW` `les di, [bp + 4]`

80386/486 only

Sample Code

```

les regDW, memFW           les esi, [bx]
push ds                    ; Push segment
mov ax, offset var         ; Load offset
push ax                    ; Push offset
;
;
push bp                    ; Save bp
mov bp, sp                 ; Address stack with bp
les di, [bp + 2]           ; Load pointer to es:di

```

Description Use `les` to load both a 16-bit general-purpose register (usually `di`) and the `es` segment register with a 32-bit pointer stored in memory. The `memDW` operand may be any of the usual addressing modes, except for a direct address, which is not permitted. The 80386/486 can load a 48-bit pointer into an extended 32-bit register plus `es`. The sample demonstrates how to set `es:di` to point to a variable, perhaps passed to a subroutine by address on the stack. The first part of the sample pushes the segment `ds` and offset values of `var` (not shown) onto the stack; the second part uses `les` along with `bp` to load `es:di` with the pointer value.

See Also `lds, lea, lfs, lgs, lss`

lfs lgs

Load Pointer and fs, gs

Processor:	8086/88	80286	80386/486	Flags:	of	df	if	tf	sf	zf	af	pf	cf
			▲		-	-	-	-	-	-	-	-	-

Purpose Loads pointer from memory into a register and `fs` (`lfs`) or into `gs` (`lgs`).

Syntax/Example `lfs regW, memDW` `lfs di, [bp + 4]`
`lfs regDW, memFW` `lfs esi, [bx]`

`lgs regW, memDW` `lgs di, [bp + 4]`
`lgs regDW, memFW` `lgs esi, [bx]`

Sample Code

```

push cs                    ; Push segment
push 0                     ; Push high offset

```

```

push offset var      ; Push low offset
:
:
push bp              ; Save bp
mov bp, sp           ; Address stack with bp
lgs edi, [bp + 2]    ; Load pointer to gs:edi
    
```

Description Use `lfs` and `lgs` to load a 16- or 32-bit offset pointer plus a 16-bit segment address value into any 16- or 32-bit register and either the `fs` or `gs` segment registers, available only on 80386/486 systems. Except for the ability to load 48-bit pointers, these two instructions are similar to `lds` and `les` and are typically used in procedures to access variables passed to subroutines by address on the stack.

See Also `lds`, `lea`, `les`, `lss`

lock

Lock the Bus

Processor: 8086/88 80286 80386/486 Flags: of df if tf sf zf af pf cf
 ▲ ▲ ▲ - - - - - - - -

Purpose Asserts bus lock signal for next instruction.

Syntax/Example `lock no operands` `lock xchg [semaphore], al`

Sample Code

```

; Note: Don't run this!
mov dl, 1                            ; Set dl to 1
@@10:
lock xchg [semaphore], dl           ; Exchange dl & memory
or dl, dl                           ; Does dl = 0?
jz @@10                              ; Jump until dl <> 0
    
```

Description Use `lock` as a prefix to instructions that reference memory shared by more than one processor. (PCs have single processors, so `lock` is rarely used in PC programming.) Typically, `lock` prefaces `xchg` on 8086/88 systems; `movs`, `ins`, and `outs` on 80286/386/486 systems; and `adc`, `add`, `and`, `bt`, `btc`, `btr`, `bts`, `dec`, `inc`, `neg`, `not`, `or`, `sbb`, `sub`, and `xor` on 80386/486 systems when one operand is a memory reference. It's not necessary to preface `xchg` with `lock` on 80286/386/486 systems, which do this automatically.

The hypothetical sample shows a typical use for `lock`—setting a flag called a *semaphore* to prepare for exclusive use of a device or, perhaps, other memory blocks. The `lock` on the `xchg` prevents two processors from accessing the same byte; therefore, if `dl` is 0, the program can safely proceed while the other processor, which is running a similar or even the same routine, will pause until the first process again resets the semaphore to 0.

See Also `xchg`

loop

Loop on cx

Processor: 8086/88 80286 80386/486 Flags: of df if tf sf zf af pf cf
 ▲ ▲ ▲ - - - - - - - - -

Purpose Decrements cx and then jumps if cx is not 0.

Syntax/Example loop *shortTarget* loop StartLoop

Sample Code

```

jcxz @@20                ; Skip loop if cx = 0
@@10:
  call Subroutine        ; Call a procedure
  loop @@10              ; cx <- cx -1; jump if cx <> 0
@@20:
    
```

Description This instruction is very handy for constructing loops that repeat for the number of times specified by register cx. At each loop execution, cx is decremented by 1. If this leaves cx not equal to 0, then a jump is made to the loop's target address, which must be no more than 126 bytes above (at a lower address than) the loop and no more than 127 bytes below (at a higher address). Because loop decrements cx *before* testing whether cx is 0, if cx = 0 at the start of a repeated section, that section will execute 65,536 times. To prevent this, precede the repeated section with jcxz as in the sample.

See Also jcxz, loope, loopz, loopne, loopnz

loope loopz

Loop on cx While Equal

Processor: 8086/88 80286 80386/486 Flags: of df if tf sf zf af pf cf
 ▲ ▲ ▲ - - - - - - - - -

Purpose Decrements cx and then jumps conditionally if cx is not 0.

Syntax/Example loope *shortTarget* loope @@20
 loopz *shortTarget* loopz StartLoop

Sample Code

```

DATASEG
  array    db '        ABCDEFG', 0
  arraySize = $-array
CODESEG
  mov cx, arraySize                ; Assign array size to cx
  mov si, offset array             ; Address array with ds:si
  cld                                ; Auto-increment si
@@10:
  lods [byte array]                ; al <- [ds:si]; si <- si + 1
  cmp al, 32                        ; Does al = 32?
  loope @@10                        ; Jump while yes & cx <> 0
  je AllBlank                       ; Jump if string = all blanks
  dec si                             ; si addresses first nonblank
    
```

Description Use either loope or loopz, both of which represent the same instruction, to decrement cx and jump to a target address if this

leaves *cx* not equal to 0 and if *zf* = 1, presumably set or reset from a previous comparison. As with *loop*, the target must be within 126 bytes back and 127 bytes forward of *loope*. The sample shows how to use *loope* to scan a byte array. The array length is assigned to *cx*; the array address to *si*. Then a three-instruction loop loads successive array bytes into *al*, jumping to *@@10*: from the *loope* instruction if *cx* is not 0 and if the previous *cmp* found 32—the ASCII value for a blank character. After the loop, a *je* detects whether all characters in the string were blank. If not, *si* is decremented, thus pointing to the first nonblank character.

See Also *loop*, *loope*, *loopnz*

loopne loopnz

Loop on *cx* While Not Equal

Processor: 8086/88 80286 80386/486 Flags: of df if tf sf zf af pf cf
 ▲ ▲ ▲ - - - - - - - -

Purpose Decrements *cx* and then jumps conditionally if *cx* is not 0.

Syntax/Example *loopne shortTarget* *loopne @@Begin*
 loopnz shortTarget *loopnz @@110*

Sample Code

```

mov cx, arraySize            ; Assign array size to cx
mov si, offset array + arraySize - 1; Address end of array
std                            ; Auto-decrement si
@@10:
lods [byte array]            ; al <- [ds:si]; si <- si - 1
cmp al, '.'                   ; Does al = '.'?
loopne @@10                  ; Jump while no & cx <> 0
jne Exit                      ; Jump if no '.' found
inc si                        ; si addresses '.'
    
```

Description These two mnemonics represent the same instruction and operate nearly identically to *loope* and *loopz*, except that the jump to a target address is made only if, after decrementing *cx*, this leaves *cx* <> 0 and if *zf* = 0. The sample uses *loopne* to locate a period in a file-name string, starting the scan at the end of the string and jumping to *Exit* (not shown) if no period is found or incrementing *si* to the period character if found.

See Also *loop*, *loope*, *loopz*

lss

Load Pointer and *ss*

Processor: 8086/88 80286 80386/486 Flags: of df if tf sf zf af pf cf
 ▲ - - - - - - - -

Purpose Loads pointer from memory into a register and *ss*.

Syntax/Example *lss regW, memDW* *lss si, [bp + 2]*
 lss regDW, memFW *lss edi, [bx]*

Sample Code	<pre> mov [oldss], ss ; Save old stack segment mov [oldsp], sp ; and old stack pointer lss sp, [newstack] ; Load ss:sp with new values ; ; mov sp, [oldsp] ; Restore sp (interrupts disabled) mov ss, [oldss] ; Restore ss </pre>
Description	<p>On 80386/486 systems, use <code>lss</code> to load a 16- or 32-bit offset pointer plus a 16-bit segment address value into any 16- or 32-bit register and the <code>ss</code> stack segment register. Normally, the offset value will be loaded into <code>sp</code>, but there's no restriction on using <code>lss</code> to load other registers. One way to use <code>lss</code> is to pick up the address of an alternative stack as the sample demonstrates.</p>
See Also	<code>lds, lea, les, lfs</code>

mov

Move Data

Processor: 8086/88 80286 80386/486 Flags: of df if tf sf zf af pf cf
 ▲ ▲ ▲ - - - - - - - -

Purpose	Moves values between registers or between registers and memory.	
Syntax/Example	<pre> mov al, memB mov ax, memW mov memB, al mov memW, ax mov regB memB, regB immB mov regW memW, regW immW mov regB, memB mov regW, memW </pre>	<pre> mov al, [abyte] mov ax, [aword] mov [abyte], al mov [aword], ax mov dl, cl mov [aword], 1024 mov dl, [abyte] mov dx, [aword] </pre>
	80386/486 only	
	<pre> mov eax, memDW mov memDW, eax mov regDW memDW, regDW immDW mov regDW, memDW </pre>	<pre> mov eax, [adword] mov [adword], eax mov edx, 99999 mov edx, [adword] </pre>
Sample Code	<pre> DATASEG var db 10 dup (0) CODESEG mov bx, 0 mov cx, 10 @@10: mov [byte var + bx], cl inc bx loop @@10 </pre>	<pre> ; A 10-byte variable ; Initialize bx to 0 ; Initialize cx to 10 ; Copy cl to memory ; Increment pointer ; Loop on cx </pre>
Description	The <code>mov</code> instruction is probably the most heavily used of all instructions in 8086 programming. Various forms of <code>mov</code> allow transferring bytes, words, and doublewords (80386/486 only)	

between registers or between registers and memory, using all the usual memory-addressing modes.

There are a few restrictions on `mov` that are not evident from the syntax list. The direction of `mov` is from right to left—transferring the value of the second operand to the first. The value of the second operand is never affected. When both operands are registers, only one of those operands may be a segment register; therefore, it's legal to write `mov es, ax` and `mov [aword], ds`, but it's *not* legal to write `mov ds, es`. When one operand is a segment register, interrupts are disabled for the *next* instruction, allowing a `mov to ss` to be followed with a `mov to sp`, eliminating the danger that an interrupt signal will occur before the full stack pointer `ss:sp` is initialized. Another restriction is that both operands may not be memory references—all moves to and from memory must pass through a register. (See `movs` for an instruction that can move values between two memory locations.)

When one register operand is `al`, `ax`, and `eax` (80386/486 only), Turbo Assembler generates a faster form of `mov`. If the accumulator is free, you should use it in `mov` instructions to improve program performance.

The sample shows how `mov` is used to initialize registers, used here to store the successive values 10,9,...,1 in a variable. Another `mov` copies the value of `c1` to memory using base-addressing mode with `bx`.

See Also

`movs`, `lods`, `stos`

movs movsb movsd movsw

Move String

Processor: 8086/88 80286 80386/486 Flags: of df if tf sf zf af pf cf
 ▲ ▲ ▲ - - - - - - - -

Purpose Moves strings of values directly between two memory locations.

Syntax/Example

```
movs memB, [es:]memB            movs [var1], [var2]
movs memW, [es:]memW            movs [var3], [es:si]
movsb no operands                movsb
movsw no operands                movsw
```

80386/486 only

```
movs memDW, [es:]memDW        movs [edi], [es:var4]
movsd no operands                movsd
```

Sample Code

```
mov ax,@data                    ; Initialize ds to address
mov ds,ax                        ; of data segment
mov es,ax                        ; Make es = ds
ASSUME es:DGROUP                ; Tell tasm where es points
mov si, offset string            ; Address source string
mov di, offset stcopy            ; Address destination
```

Description

```

mov cx, strlen           ; Assign count to cx
jcxz Exit               ; Don't copy if cx = 0
cld                     ; Auto-increment si, di
rep movsb               ; Copy string to strcpy

```

The `movs` instruction, plus its shorthand forms `movsb`, `movsd` (80386/486 only), and `movsw`, moves one value in memory directly to another memory location. The first operand must be `es:di`, addressing the destination for the move. The second operand must be `ds:si` or with a segment override `es:si`, addressing the source for the move. The extended 32-bit registers `edi` and `esi` may be used in 80386/486 programs. Executing `movs` copies 1 byte from the source location to the destination. After this, if `df = 0`, both `si` and `di` (or `esi` and `edi`) are advanced by the number of bytes being moved. If `df = 1`, the two registers are decremented by the number of bytes being moved. These register assignments are fixed—even, as in some of the examples, if you specify explicit labels, which Turbo Assembler will check to ensure that the variables are in the appropriate segments. It's still your responsibility to load `di` and `si` with the offset addresses of the variables. The shorthand forms of `movs` require no operands. There are no operational differences between the different mnemonics.

Usually, `movs` is prefaced with a `rep` prefix, repeating the instruction for the number of times specified in `cx`. As the sample shows, this lets you create powerful instructions to move blocks of memory from one place to another—in this case, copying string to `strcpy`. As a reminder, the instructions to initialize segment registers are also shown in the sample. Effectively using `movs` (as well as other string instructions) requires careful planning and control of segment registers.

See Also

```

cmpsb, cmpsd, cmpsw, ins, insb, insd, insw, lods, lodsb, lodsd,
lodsw, outs, outsb, outsd, outsw, rep, scas, scasb, scasd, scasw,
stos, stosb, stosd, stosw

```

MOVSB**Move and Extend Sign**

Processor: 8086/88 80286 80386/486 Flags: of df if tf sf zf af pf cf

Purpose

Moves signed values from smaller registers and memory locations into larger registers, extending the sign bit.

Syntax/Example

```

movsx regW, regB | memB   movsx dx, al
movsx regDW, regB | memB  movsx eax, [abyte]
movsx regDW, regW | memW  movsx edx, dx

```

Sample Code

```

mov al, -1                ; al = -1
mov dx, 0                  ; dx = 00000h
movsx dx, al               ; dx = 0FFFFh

```

```

mov [abyte], -1           ; [abyte] = -1
mov eax, 0                ; eax = 00000000h
movsx eax, [abyte]       ; eax = 0FFFFFFFh

mov ax, -1               ; ax = -1
mov edx, 0               ; edx = 00000000h
movsx edx, ax           ; edx = 0FFFFFFFh
    
```

Description

On 80386/486 systems, use `movsx` to copy signed values with fewer numbers of bits to larger registers. For example, you can use `movsx` to load a word register such as `ax` with a byte value from memory and have the processor automatically initialize `ah`, extending the sign of the copied value as needed. The destination (first operand) to `movsx` must be a register. The source (second operand) may be a register or memory reference. The samples demonstrate how to use `movsx` to transfer values between dissimilar registers.

See Also

`mov`, `movs`, `movzx`

MOVZX

Move and Extend Zero Sign

Processor: 8086/88 80286 80386/486 Flags: of df if tf sf zf af pf cf



Purpose

Moves unsigned values from smaller registers and memory locations into larger registers, zeroing the most significant digits.

Syntax/Example

```

movzx regW, regB | memB   movzx bx, [abyte]
movzx regDW, regB | memB  movzx edx, dl
movzx regDW, regW | memW  movzx edx, [aword]
    
```

Sample Code

```

mov al, -1                ; al = 1
mov dx, -1                ; dx = 0FFFFh
movzx dx, al              ; dx = 00001h

mov [abyte], 1           ; [abyte] = 1
mov eax, -1              ; eax = 0FFFFFFFh
movzx eax, [abyte]       ; eax = 00000001h

mov ax, 1                ; ax = 1
mov edx, -1              ; edx = 0FFFFFFFh
movzx edx, ax            ; edx = 00000001h
    
```

Description

On 80386 systems, use `movzx` to copy unsigned values with fewer numbers of bits to larger registers—similar to the way you can use `movsx`. For example, `movzx` can load an extended 32-bit register such as `ecx` with a word value from memory and have the processor automatically zero the upper 16-bits of `ecx`. The destination (first operand) to `movzx` must be a register. The source (second operand) may be a register or memory reference. The samples demonstrate how to use `movzx` to transfer values between dissimilar registers.

See Also

`mov`, `movs`, `movsx`

mul

Unsigned Multiplication

Processor: 8086/88 80286 80386/486 Flags: of df if tf sf zf af pf cf
 ▲ ▲ ▲ ▲ - - - u u u u ▲

Purpose Multiplies two unsigned values.

Syntax/Example `mul regB | memB` `mul b1`
 `mul regW | memW` `mul [aword]`

80386/486 only
`mul regDW | memDW` `mul ebx`

Sample Code

```

DATASEG
multiplicand dw 1024
multiplier   dw 32
answer       dw 0
CODESEG
mov ax, [multiplicand] ; Load multiplicand into ax
mul [multiplier]       ; dx:ax <- ax * multiplier
jc Exit                ; Jump if result > 16 bits
mov [answer], ax       ; Else store answer
    
```

Description Unsigned multiplication in 8086 programming is considerably similar than signed multiplication (see `imul`). The single operand to `mul` must be a general-purpose register or a memory reference, representing the multiplier. The size of the multiplier determines the location of the multiplicand and product. If the multiplier is a byte, then the multiplicand is `al`, and the product is deposited in `ax`. If the multiplier is a word, then the multiplicand is `ax`, and the result is placed in `dx:ax` with `ax` holding the low-order portion of the result. If the multiplier is a doubleword (80386/486 only), then the multiplicand is in `eax`, and the product appears in `edx:eax`, with the low-order 32 bits in `eax`. Overflow of the destination registers is not possible.

After `mul`, the `of` and `cf` flags can be used to determine the size of the result. Both flags are set to 1 if the product takes more bits than the specified source; otherwise, both flags are set to 0. Thus, if `cf = 0` after `mul b1`, then `ah` is 0, and the 8-bit result fits in `al`. If `cf = 1` after `mul bx`, then the result occupies the full 32-bit double register `dx:ax`. As the sample demonstrates, you can optionally test `cf` (or `of`) after `mul` to detect a result larger than the size of the original operands.

See Also `imul`

neg

Two's Complement Negation

Processor:	8086/88	80286	80386/486	Flags:	of	df	if	tf	sf	zf	af	pf	cf
	▲	▲	▲		▲	-	-	-	▲	▲	▲	▲	▲

Purpose Negates (forms two's complement) of a value.**Syntax/Example** `neg regB | memB` `neg [abyte]`
`neg regW | memW` `neg ax`**80386/486 only**`neg regDW | regDW` `neg edx`**Sample Code**

```

mov ax, 6           ; Assign values to
mov dx, 8           ; ax and dx
sub ax, dx          ; ax ← ax - dx (ax = 0FFFEh)
jae @@10           ; Jump if ax >= 0
neg ax              ; Find absolute value (ax = 0002)
mov dl, '-'         ; Display a minus sign
mov ah, 2           ; via DOS function 2
int 21h            ; Call DOS
@@10:              ; Continue here

```

Description

Apply `neg` to form the two's complement of a register or memory value. When the original value is a negative number in two's complement form, `neg` finds the absolute positive equivalent of the value. The instruction operates by subtracting the original value from 0, an operation that is logically equivalent to toggling all bits in the value from 0 to 1 and from 1 to 0, and then adding 1. As the sample demonstrates, if the result of a subtraction is negative, a minus sign can be sent to the standard DOS output file, and the result in `ax` can be negated. Not shown is the code after `@@10`: that would then write the absolute value of `ax` to the standard output, thus displaying the full negative number in decimal.

See Also`not`**nop**

No Operation

Processor:	8086/88	80286	80386/486	Flags:	of	df	if	tf	sf	zf	af	pf	cf
	▲	▲	▲		-	-	-	-	-	-	-	-	-

Purpose Occupies 1 byte of machine code but has no operational effect.**Syntax/Example** `nop no operands` `nop`**Sample Code**

```

jmp @@20           ; Jump to forward label
nop               ; Inserted by Turbo Assembler...
;
;
@@20              ; ...if this label is within about
; 128 bytes

```

Description

Turbo Assembler inserts `nop` instructions to reserve bytes in cases where the exact size of an instruction is determined by code later in the program. For example, a `jmp` to a forward label is assumed to be 3 bytes long. But if the `jmp` destination proves to be within about 128 bytes, the assembler changes the `jmp` to a more efficient 2-byte form, leaving the unneeded third byte equal to a `nop`. (You can avoid this situation by prefacing the target address of forward labels with the `SHORT` operator.) Another use for `nop` is during debugging. If you want to remove an instruction, instead of quitting the debugger, loading your editor, making a modification, and reassembling, just poke a few `nop` bytes (90h) over the instruction. You can then run the program and examine the effects without this instruction in place—a useful debugging technique. Some references recommend using `nop` to adjust the timing of software loops, although because it is almost impossible to predict the exact timings of multiple instructions in 8086 programming—especially in an interrupt-driven computer system—this use of `nop` is dubious.

The `nop` instruction is identical to the instructions `xchg ax, ax` and `xchg eax, eax` (80386/486 only), both of which assemble to the same machine code as `nop`.

See Also

`xchg`

not**One's Complement Negation**

Processor: 8086/88 80286 80386/486 Flags: of df if tf sf zf af pf cf

**Purpose**

Toggles all 1 bits to 0 and all 0 bits to 1 in a value.

Syntax/Example

```
not regB | memB      not dh
not regW | memW      not dx
```

80386/486 only

```
not regDW | memDW   not [dword var]
```

Sample Code

```
DATASEG
false EQU 0           ; Value representing false
true EQU -1           ; Value representing true
flag db true          ; Initialize flag to true
CODESEG
cmp [flag], false    ; Is the flag false?
je @@10              ; Jump if flag = false
call Subroutine      ; Else call a subroutine
@@10:
not [flag]           ; Toggle flag value
```

Description

Use `not` to toggle all 1 bits in a value to 0 and all 0 bits to 1. This is often useful for toggling the value of a true and false flag, as in the sample. (The referenced subroutine is not shown.)

See Also

`neg`

or

Logical OR

Processor:	8086/88	80286	80386/486	Flags:	of	df	if	tf	sf	zf	af	pf	cf
	▲	▲	▲		0	-	-	-	▲	▲	u	▲	0

Purpose Logically ORs two byte, word, or doubleword (80386/486 only) values.

Syntax/Example

```

or al, immB           or ax, 80h
or ax, immW           or ax, 01h
or regB | memB, immB or bl, 0AAh
or regW | memW, immW or [word bx], 0800h
or regW | memW, immB or cx, 03h
or regB | memB, regB  or [byte bx], dl
or regW | memW, regW  or dx, dx
or regB, regB | memB  or bl, bh
or regW, regW | memW  or dx, [word bx]
    
```

80386/486 only

```

or eax, immDW         or eax, 08000000h
or regDW | memDW, immDW or edx, 0FFFF000h
or regDW | memDW, immB or [dword bx], 01h
or regDW | memDW, regDW or dx, ecx
or regDW, regDW | memDW or ecx, [dword bx]
    
```

Sample Code

```

mov ax, 01234h        ; ax = 01234h
and ax, 000FFh       ; ax = 00034h
or ax, 08000h        ; ax = 08043h

or dx, dx            ; Does dx = 0?
jz Target            ; Jump if dx = 0
                    ; Continue if dx <> 0
    
```

Description Use `or` to perform a logical OR on the bits in any two byte, word, or doubleword (80386/486 only) values stored in registers or in memory variables. (Both of the two operands can't be memory references.) The corresponding bits in the first operand are set to 1 only if the bits in either or both of the operands equal 1. The first part of the sample uses `or` to set the MDS of a word value in `ax` to 1, after `ah` is zeroed by a previous and with a mask of `000FFh`.

Another typical use for `or` is to test whether a value equals 0, as the second part of the sample demonstrates. ORing a value with itself sets the zero flag to 1, without changing the original value, only if all bits in the value are 0. Note that this also sets both `of` and `of` to 0, a fact that might be useful in some circumstances.

See Also `and`, `xor`

out

Output to Port

Processor:	8086/88	80286	80386/486	Flags:	of	df	if	tf	sf	zf	af	pf	cf
	▲	▲	▲		-	-	-	-	-	-	-	-	-

Purpose Outputs values to ports.

Syntax/Example

```
out immB, al      out 14h, al
out dx, al        out dx, al
out immB, ax      out 01Fh, ax
out dx, ax        out dx, ax
```

80386/486 only

```
out immB, eax     out 0Fh, eax
out dx, eax       out dx, eax
```

Sample Code

```
Ctrl8259 EQU 021h ; 8259 masks port
in al, Ctrl8259   ; Read 8259 enable masks
and al, EnableIRQ ; Clear masked bit
out Ctrl8259, al  ; Write new 8259 masks
```

Description The out instruction writes a value in al, ax, or eax (80386/486 only) to a hardware port. As the sample shows, out is often used in conjunction with in and logical instructions such as and and or to examine and change bit switches at various port addresses in the computer. (This is the same sample shown for in.) The simplest form of out writes a byte in al to an immediate port address in the range 0–255. To access higher port addresses, specify the address in the dx register.

See Also in, outs

outs outsb outsd outsw

Output From String to Port

Processor:	8086/88	80286	80386/486	Flags:	of	df	if	tf	sf	zf	af	pf	cf
		▲	▲		-	-	-	-	-	-	-	-	-

Purpose Outputs a sequence of bytes, words, or doublewords from memory to ports.

Syntax/Example

```
outs dx, [es:]si | memB  rep outs dx, [var]
outs dx, [es:]si | memW  rep outs dx, [word var]
outsb no operands      rep outsb
outsw no operands      rep outsw
```

80386/486 only

```
outs dx, regDW | memDW  rep outs dx, [dword var]
outsd no operands      rep outsd
```

Sample Code ; Note: don't run this!

```

DATASEG
string db 'A string is a wonderful thing'
slen = $-string
CODESEG
mov si, offset string ; Address string with ds:si
mov dx, <port number> ; Assign port number to dx
mov cx, slen ; Assign string length to cx
cld ; Auto-increment si
rep outsb ; Send string to output port

```

Description As with all string instructions, outsb (and its shorthand forms outsb, outsd [80386/486 only], and outsw) register assignments are fixed, even if you specify address labels explicitly. The source register is ds:si unless an es: override is used as in [byte es:si] or [word es:var]. The port number must be placed in dx. (Don't forget to do this also for the shorthand mnemonics.) If df = 0, then outsb increments si; if df = 1, outsb decrements si by the number of bytes being sent to the output port with each use of outsb. Normally, you'll preface outsb with rep, repeating the instruction for the number of times specified in cx as illustrated in the sample.

See Also cmpsb, cmpsd, cmpsw, ins, insb, insd, insw, lodsb, lodsd, lodsw, movsb, movsd, movsw, scas, scasb, scasd, scasw, stos, stosb, stosd, stosw

pop

Pop from Stack

Processor: 8086/88 80286 80386/486 Flags: of df if tf sf zf af pf cf

Purpose Removes a word or doubleword (80386 only) from the stack.

Syntax/Example

```

pop regW ; pop ax
pop memW ; pop [word var]
pop es | ds | ss ; pop es

```

80386/486 only

```

pop regDW ; pop ecx
pop memDW ; pop [dword var]
pop fs | gs ; pop gs

```

Sample Code

```

push ax ; Save ax on stack
push bx ; Save bx on stack
;
; various instructions
;
pop bx ; Restore saved bx value
pop ax ; Restore saved ax value
push cs ; Push cs onto the stack
pop es ; Pop ds, making ds = cs

```

Description

Execute `pop` to remove one word or doubleword (80386/486 only) value from the stack location addressed by `ss:sp` or by `ss:esp` on the 80386/486. After copying the stack value into the specified register, `sp` or `esp` are incremented by the number of bytes transferred. Having done this, the value above (at a lower address than) the new stack pointer is subject to being overwritten by other code.

The most common use for `pop` (see first part of sample) is to restore a register value previously inserted into the stack with `push`. Another use for `pop` is to load a segment register as in the second part of the sample, which sets `es` equal to `cs`. (Popping into the `cs` register is forbidden.) When popping values into a segment register, interrupts are temporarily disabled for the *next* instruction, thus allowing `pop ss` to be followed by `pop sp` without the danger that an interrupt will occur before the full stack pointer is initialized.

Often neglected is the ability to `pop` values into word and doubleword (80386/486 only) memory locations, using all memory-addressing modes. Thus, instructions such as `pop [aword + bx + si]` and `pop [aword + si]` are perfectly allowable, if somewhat unusual, commands.

See Also

`popa`, `popad`, `popf`, `popfd`, `push`, `pusha`, `pushad`, `pushf`, `pushfd`

popa

Pop All General-Purpose Registers

Processor:	8086/88	80286	80386/486	Flags:	of	df	if	tf	sf	zf	af	pf	cf
		▲	▲		-	-	-	-	-	-	-	-	-

Purpose

Removes registers `di`, `si`, `bp`, `sp` (discarded), `bx`, `dx`, `cx`, and `ax` from the stack.

Syntax/Example

`popa no operands` `popa`

Sample Code

```
PROC AnyProc
pusha                ; Save all general-purpose registers
;
; Procedure code
;
popa                 ; Restore general-purpose registers
ret                  ; Return to caller
ENDP
```

Description

Use `popa` on 80286 and 80386/486 systems to `pop` the 16-bit registers `di`, `si`, `bp`, `sp`, `bx`, `dx`, `cx`, and `ax` in that order from the stack. Although the saved value for `sp` is removed from the stack, the value is not inserted into `sp`. Normally, you'll use `popa` after previously having executed `pusha` to push these same register values (in the opposite order). The instruction uses 16 bytes of stack space.

See Also

`pop`, `popad`, `popf`, `popfd`, `push`, `pusha`, `pushad`, `pushf`, `pushfd`

16

popad

Pop All General-Purpose Doubleword Registers

Processor: 8086/88 80286 80386/486 Flags: of df if tf sf zf af pf cf

<i>Purpose</i>	Removes registers edi, esi, ebp, esp (discarded), ebx, edx, ecx, and eax from the stack.
<i>Syntax/Example</i>	popad <i>no operands</i> popad
<i>Sample Code</i>	<pre>pushad ; Save general-purpose 32-bit registers ; ; other code ; popad ; Restore saved registers</pre>
<i>Description</i>	Use popad on 80386/486 systems to pop the 32-bit registers edi, esi, dbp, esp, ebx, edx, ecx, and eax in that order from the stack. Although the saved value for esp is removed from the stack, the value is not inserted into esp. Normally, you'll use popad after previously having executed pushad to push these same register values (in the opposite order). The instruction uses 32 bytes of stack space.
<i>See Also</i>	pop, popa, popf, popfd, push, pusha, pushad, pushf, pushfd

popf

Pop Flags

Processor: 8086/88 80286 80386/486 Flags: of df if tf sf zf af pf cf

<i>Purpose</i>	Removes all flags from the stack.
<i>Syntax/Example</i>	popf <i>no operands</i> popf
<i>Sample Code</i>	<pre>xor ax, ax ; Set ax = 0000 push ax ; Push ax onto stack popf ; Pop stack into flags, thus ; resetting all flags to 0</pre>
<i>Description</i>	Execute popf to remove the top word from the stack and insert the bits in that word into the 8086 flags. Normally, you'll do this after previously executing pushf to push the flag values, perhaps to preserve the result of a comparison or other instruction. Another use for popf is to remove the flags from the stack in an interrupt service routine. You can also assign various bit values in a word register, push that register onto the stack, and then execute popf to transfer the bits to the flags, thus setting the flags to your new values.
<i>See Also</i>	pop, popa, popad, popfd, push, pusha, pushad, pushf, pushfd

popfd

Pop Extended Flags

Processor:	8086/88	80286	80386/486	Flags:	of	df	if	tf	sf	zf	af	pf	cf
		▲			▲	▲	▲	▲	▲	▲	▲	▲	▲

Purpose Removes extended 80386 flags except *vm* and *rf* from the stack.

Syntax/Example `popfd no operands` `popfd`

Sample Code

```

pushfd                ; Save extended flags
;
; other code
;
popfd                ; Restore extended flags

```

Description Execute `popfd` to remove the two top words from the stack and insert the bits in those words into the 80386/486 extended flag register. Normally, you'll do this after previously executing `pushfd` to push the extended flag values, perhaps to preserve the results of a comparison or other instruction. (See `popf` for other potential uses.) The 80386/486 *vm* (virtual 8086 flag, bit 17) and *rf* (resume flag, bit 16) are not changed by `popfd`.

See Also `pop`, `popa`, `popad`, `popf`, `push`, `pusha`, `pushad`, `pushf`, `pushfd`

push

Push Onto Stack

Processor:	8086/88	80286	80386/486	Flags:	of	df	if	tf	sf	zf	af	pf	cf
	▲	▲	▲		-	-	-	-	-	-	-	-	-

Purpose Transfers values to the stack.

Syntax/Example

```

push regW            push ax
push memW           push [word bx]
push cs | es | ds | ss  push cs

```

80286, 80386/486 only

```

push immB           push 0Fh
push immW           push 256

```

80386/486 only

```

push regDW          push ecx
push memDW          push [dword bx]
push immDW          push 99999
push fs | gs        push gs

```

Sample Code

```

push ax             ; Save ax on stack
push bx             ; Save bx on stack
push cx             ; Save cx on stack
;
; other code that changes ax, bx, cx
;

```

```
pop cx      ; Restore original cx
pop bx      ; Restore original bx
pop ax      ; Restore original ax
```

P386

```
push 99999  ; Turbo Assembler incorrectly disallows this
;
db 066h, 068h ; But you can code the instruction
dd 99999      ; with these two lines
```

Description

Use `push` to transfer a word or doubleword (80386 only) to the stack. Executing `push` first decrements the stack pointer by 2 (or by 4 in the case of an 80386 doubleword push). Then the value of the specified operand is copied into the location addressed by `ss:sp`. Note that this causes the stack to grow toward lower-memory addresses. The most common use of `push` is to save register values onto the stack, as the first part of the sample demonstrates. Later, `pop` can be used to remove the saved values, restoring the original registers.

It is legal to `push` but not to `pop` the value of the code-segment register `cs`. Also, you can `push` values from memory, using all the usual addressing modes. Thus, instructions such as `push [bx]` and `push [value + si]` are legal but often neglected forms of the instruction. In addition, the 80286 and 80386/486 processors allow pushing immediate values, for example `push 0` or `push -1`.

A bug in Turbo Assembler 1.0 prevents pushing 32-bit immediate values with instructions such as `push 99999`, which produces a “constant too large” error. To circumvent this presumably temporary problem, use the `db` and `dd` commands in the second part of the sample to insert the machine code for this instruction directly into your program.

See Also

`pop`, `popa`, `popad`, `popf`, `popfd`, `pusha`, `pushad`, `pushf`, `pushfd`

pusha

Push All General-Purpose Registers

Processor:	8086/88	80286	80386/486	Flags:	of	df	if	tf	sf	zf	af	pf	cf
		▲	▲		-	-	-	-	-	-	-	-	-

Purpose

Transfers registers `ax`, `cx`, `dx`, `bx`, `sp`, `bp`, `si`, and `di` to the stack.

Syntax/Example

```
pusha no operands      pusha
```

Sample Code

```
PROC Anyproc
pusha                ; Save general-purpose registers
;
; other code
;
popa                 ; Restore registers
ret                  ; Return to caller
ENDP
```

Description

Use *rc1* to rotate the bits in word, byte, and doubleword (80386/486 only) registers and memory values to the left (toward the MSDs) including the carry flag *cf* as part of the original value. In other words, the old MSD shifts into *cf*, which shifts into the new LSD, while all other bits shift one position to the left. Repeating this action would eventually restore the original value and *cf*.

For all processors, the second operand specifies the number of bit rotations to perform. On the 8086 and 8088 processors, if the second operand is literal, it must equal 1. To rotate more than one bit, you must assign the rotation count to *c1* and specify this register as the second operand. The 80286 and 80386/486 processors allow you to use any immediate value as the second operand, for example as in *rc1 cx, 4* to rotate *cx* 4 bits left. The 80386/486 further extends these forms by allowing rotations involving 32-bit extended registers.

When the second operand is an immediate 1, after *rc1* the *of* flag equals the exclusive OR of *cf* and the MSD of the newly rotated value. Thus, if *of* = 1 after *rc1 reg | mem, 1*, then the upper 2 bits of the original value were either 11 or 00. One way to use this knowledge is to stop a rotation as soon as a 1 bit appears in the rotated value's MSD. For example, if the original value in *ax* is 01000000b, executing *rc1 ax, 1* results in *cf* = 0 and *ax* = 10000000b, which sets *of* to 1, a condition that you can test with *jo* or *jno*. In all other cases, when the second operand to *rc1* is not an immediate 1, the *of* flag is not defined. Also, if the rotation count is 0, *of* and *cf* are left unchanged—an oddity of little practical value.

See Also

rcr, rol, ror, sal, sar, shl, shr

rcr

Rotate Right Through Carry

Processor:	8086/88	80286	80386/486	Flags:	of	df	if	tf	sf	zf	af	pf	cf
	▲	▲	▲	▲u	-	-	-	-	-	-	-	-	▲
Purpose	Rotates bits rightward through the carry flag.												
Syntax/Example	<i>rcr regB memB, 1</i>			<i>rcr al, 1</i>									
	<i>rcr regB memB, cl</i>			<i>rcr [abyte], cl</i>									
	<i>rcr regW memW, 1</i>			<i>rcr [aword], 1</i>									
	<i>rcr regW memW, cl</i>			<i>rcr bx, cl</i>									
	80286, 80386/486 only												
	<i>rcr regB memB, immB</i>			<i>rcr dl, 4</i>									
	<i>rcr regW memW, immB</i>			<i>rcr [aword], 4</i>									
	80386/486 only												
	<i>rcr regDW memDW, 1</i>			<i>rcr eax, 1</i>									
	<i>rcr regDW memDW, cl</i>			<i>rcr [dword bx], cl</i>									
	<i>rcr regDW memDW, immB</i>			<i>rcr ecx, 4</i>									

Sample Code

```
mov cl, 2      ; Assign rotation count to cl
rcr ax, cl     ; Rotate ax right by count in cl
```

Description

Use `rcr` to rotate the bits in word, byte, and doubleword (80386/486 only) registers and memory values to the right (toward the LSDs) including the carry flag `cf` as part of the original value. In other words, the old LSD shifts into `cf`, which shifts into the new MSD, while all other bits shift one position to the left. Repeating this action would eventually restore the original value and `cf`.

For all processors, the second operand specifies the number of bit rotations to perform. On the 8086 and 8088 processors, if the second operand is literal, it must equal 1. To rotate more than 1 bit, you must assign the rotation count to `cl` and specify this register as the second operand. The 80286 and 80386/486 processors allow you to use any immediate value as the second operand, for example as in `rcr dx, 3` to rotate `dx` 3 bits right. The 80386/486 further extends these forms by allowing rotations involving 32-bit extended registers.

When the second operand is an immediate 1, after `rcr` the `of` flag equals the exclusive OR of the two MSDs of the newly rotated value. Thus, if `of = 1` after `rcr reg | mem, 1`, then `cf` and the original MSD were different; otherwise, they were both equal to 1 or 0. Stated another way, `of = 1` indicates a change in sign of the original value as a result of the rotation. In all other cases, when the second operand to `rcr` is not an immediate 1, the `of` flag is not defined. Also, if the rotation count is 0, `of` and `cf` are left unchanged—an oddity of little practical value.

See Also

`rcl`, `rol`, `ror`, `sal`, `sar`, `shl`, `shr`

rep repe repz

Repeat, Repeat While Equal

Processor:	8086/88	80286	80386/486	Flags:	of	df	if	tf	sf	zf	af	pf	cf
	▲	▲	▲		-	-	-	-	-	-	-	-	-

Purpose

Conditionally repeats a string instruction.

Syntax/Example

```
rep movs | movsb | movsw  rep movs [byte di], [byte es:si]
rep stos | stosb | stosw  rep stosw
repe cmps | cmpsb | cmpsw  repe cmps [word str1], [word
str2]
repz cmps | cmpsb | cmpsw  repz cmpsb
repe scas | scasb | scasw  repe scasw
repz scas | scasb | scasw  repz scas [byte es:var]
```

80286, 80386/486 only

```
rep ins | insb | insw  rep insb
rep outs | outsb | outsw  rep outs dx, [word es:si]
```

80386/486 only

<code>rep movs movsd</code>	<code>rep movs [dword edi], [dword esi]</code>
<code>rep stos stosd</code>	<code>rep stosd</code>
<code>rep ins insd</code>	<code>rep ins [dword var], dx</code>
<code>rep outs outsd</code>	<code>rep outs dx, [dword si]</code>
<code>repe cmps cmpsd</code>	<code>repe cmpsd</code>
<code>repz cmps cmpsd</code>	<code>repz cmps [dword str1], [dword str2]</code>
<code>repe scas scasd</code>	<code>repe scasd</code>
<code>repz scas scasd</code>	<code>repz scas [dword es:esi]</code>

Sample Code

```

UDATASEG
string db 80 dup (?) ; Uninitialized variable
strlen = $ - string ; Length of string
CODESEG
mov ax, @data ; Initialize es
mov es, ax ; segment register
ASSUME es:DGROUP ; Tell tasm where es points
mov di, offset string ; Address string with es:di
mov cx, strlen ; Assign string length to cx
cld ; Auto-increment di
mov al, ' ' ; Assign ASCII value to al
rep stosb ; Fill string with blanks

```

Description

The three mnemonics `rep`, `repe`, and `repz` represent the same instruction prefix, which may be attached to any string instruction as shown in the examples and the sample code. Even though the mnemonics are identical, the effects differ depending on the strong instruction that is prefaced. Use `rep` before `movs`, `stos`, `ins`, and `outs`—plus the shorthand mnemonics for these instructions. Use `repe` and `repz` before `cmps` and `scas` plus shorthand equivalents.

The `rep` prefix repeats the string instruction that follows the number of times specified in `cx`. The `repe` and `repz` also repeat a string instruction by the value in `cx` but end the repetition if, after any iteration, `zf = 0`. Thus, you can use these two prefixes to repeat a string compare or scan for a certain number of times or until the string instruction locates a specific value. The `lodsb` instruction (and its shorthand mnemonics) may be repeated, although there is never any good reason to do so. (The result of a repeated `lodsb` instruction is to load the accumulator with one value after all repetitions are finished—there is no way to use the intermediate loaded values.)

See the various string instructions elsewhere in this chapter for more details and for the operands that you may use with instructions such as `cmps`, which, for brevity, are not repeated here. Also, although the repeat prefixes are listed here as not changing any flags, be aware that the string instructions following the prefixes can change flag settings.

See Also

`cmps`, `ins`, `movs`, `outs`, `repne`, `repnz`, `scas`, `stos`

repne repnz

Repeat While Not Equal

Processor:	8086/88	80286	80386/486	Flags:	of	df	if	tf	sf	zf	af	pf	cf
	▲	▲	▲		-	-	-	-	-	-	-	-	-

Purpose Conditionally repeats a string compare or scan instruction.

Syntax/Example

```
repne cmps | cmpsb | cmpsw repne cmps [word str1], [word str2]
repnz cmps | cmpsb | cmpsw repnz cmpsb
repne scas | scasb | scasw repne scasw
repnz scas | scasb | scasw repnz scas [byte es:var]
```

80386/486 only

```
repne cmpsd repne cmpsd
repnz cmpsd repnz cmps [dword str1], [dword str 2]
repne scasd repne scasd
repnz scasd repnz scas [dword es:esi]
```

Sample Code

```
DATASEG
string db 'Thisstringhasn''tanyblanks'
strlen = $ - string
CODESEG
mov ax, @data ; Initialize es
mov es, ax ; segment register
ASSUME es:DGROUP ; Tell tasm where es points
mov di, offset string + strlen - 1 ; Address end of string
mov cx, strlen ; Assign string length to cx
std ; Auto-decrement di
mov al, ' ' ; Value to search for
repne scasb ; Scan for blanks
jcxz Exit ; Exit if no blanks found
; es:di addresses last nonblank
```

Description

The `repne` and `repnz` prefixes, both of which represent the same machine code, repeat a `cmps` or `scas` string instruction (plus shorthand mnemonics) for the number of times specified in `cx` but end the repetitions early if an iteration sets `zf = 1`. For more details, see the notes for `repe` and `repz`, which operate similarly but recognize the opposite flag value for `zf`. The example demonstrates how to use `repne` to scan a string from back to front, leaving `di` addressing the last nonblank in the string or, if no blanks were found, jumping to label `Exit` (not shown).

See Also

`cmps`, `ins`, `movs`, `outs`, `rep`, `repe`, `repz`, `scas`, `stos`

repz

Repeat While Zero

Processor:	8086/88	80286	80386/486	Flags:	of	df	if	tf	sf	zf	af	pf	cf
	▲	▲	▲		-	-	-	-	-	-	-	-	-

See

`rep` `repe`

ret retf retn

Return, Return Far or Near

Processor: 8086/88 80286 80386/486 Flags: of df if tf sf zf af pf cf

▲ ▲ ▲ - - - - - - - -

Purpose Returns from a subroutine procedure.

Syntax/Example

```
ret no operands      ret
retn no operands    retn
retf no operands    retf
ret immW             ret 8
retn immW           retn 16
retf immW           retf 4
```

Sample Code

```
PROC AnyProc
;
; procedure code
;
ret                ; Return to caller
ENDP AnyProc
```

Description The three `ret` mnemonics are typically used as the final instruction of a procedure activated by `call`. Both `ret` and `retn`, which are synonyms for the same instruction, pop the 16-bit return address from the stack into register `ip`, continuing the program with the instruction that follows the `call`, which previously pushed this address onto the stack before activating the procedure. The `retf` instruction pops two words from the stack, assigning the first word to `cs` and the second to `ip`. Thus, the program continues in a different code segment. Use `retf` *only* if you made a *far* call to the subroutine, usually by using the instruction `call FAR AnyProc`.

When using simplified memory models (as in most of this book's example programs), it's probably best to use only `ret`. This lets Turbo Assembler decide whether to assemble the code for `retf` or `retn` as needed and also to use the appropriate `call` instruction. You can force near and far calls and returns, but be aware that using `retf` when you should have used `retn` will undoubtedly cause a system crash sooner or later—probably sooner.

You may follow any of the three mnemonics with an unsigned value, which will be added to the stack pointer *after* the return address is popped. High-level languages such as Pascal use this form of `ret` to end procedures and functions to which parameters have been passed on the stack. Adjusting the stack pointer with `ret` lets the procedure itself remove the stacked parameters instead of leaving it to the calling code. Because the optional value added to `ret` is immediate (fixed), the method is not as helpful in languages such as C, which allow a variable number of parameters to be passed to functions.

See Also`call`

rol

Rotate Left

Processor:	8086/88	80286	80386/486	Flags:	of	df	if	tf	sf	zf	af	pf	cf
	▲	▲	▲		▲u	-	-	-	-	-	-	-	▲

Purpose Rotates bits leftward.

Syntax/Example

```

rol regB | memB, 1      rol al, 1
rol regB | memB, cl     rol [abyte], cl
rol regW | memW, 1      rol [aword], 1
rol regW | memW, cl     rol bx, cl

```

80286, 80386/486 only

```

rol regB | memB, immB   rol dl, 4
rol regW | memW, immB   rol [aword], 4

```

80386/486 only

```

rol regDW | memDW, 1    rol eax, 1
rol regDW | memDW, cl   rol [dword bx], cl
rol regDW | memDW, immB   rol ecx, 4

```

Sample Code

```

mov cl, 5                ; Load count into cl
rol [aword], cl          ; Rotate word left 5 times

```

Description

Use `rol` to rotate the bits in word, byte, and doubleword (80386/486 only) registers and memory values to the left (toward the MSDs). The old MSD shifts into the new LSD position while all other bits shift one position to the left. In addition, the old MSD is copied into `cf`. Repeating this action would eventually restore the original value but not necessarily restore `cf`. (This is nearly identical to the way `rc1` operates, except that `cf` is not treated as an extra bit in the rotated value.)

For all processors, the second operand specifies the number of bit rotations to perform. On the 8086 and 8088 processors, if the second operand is literal, it must equal 1. To rotate more than 1 bit, you must assign the rotation count to `cl` and specify this register as the second operand. The 80286 and 80386/486 processors allow you to use any immediate value as the second operand, for example as in `rol dx, 2` to rotate `dx` 2 bits left. The 80386/486 further extends these forms by allowing rotations involving 32-bit extended registers.

When the second operand is an immediate 1, after `rol` the `of` flag equals the exclusive OR of `cf` and the MSD of the newly rotated value. (See `rc1` for an expanded discussion of these flag values.) In all other cases, when the second operand to `rc1` is not an immediate 1, the `of` flag is not defined. Also, if the rotation count is 0, `of` and `cf` are left unchanged—an oddity of little practical value. Of more use might be the associated fact that, after every `rol`, `cf` equals the LSD of the newly rotated value.

ror

Rotate Right

Processor:	8086/88	80286	80386/486	Flags:	of	df	if	tf	sf	zf	af	pf	cf
	▲	▲	▲		▲u	-	-	-	-	-	-	-	▲

Purpose Rotates bits rightward.

Syntax/Example

<code>ror regB memB, 1</code>	<code>ror al, 1</code>
<code>ror regB memB, cl</code>	<code>ror [abyte], cl</code>
<code>ror regW memW, 1</code>	<code>ror [aword], 1</code>
<code>ror regW memW, cl</code>	<code>ror bx, cl</code>

80286, 80386/486 only

<code>ror regB memB, immB</code>	<code>ror dl, 4</code>
<code>ror regW memW, immB</code>	<code>ror [aword], 4</code>

80386/486 only

<code>ror regDW memDW, 1</code>	<code>ror eax, 1</code>
<code>ror regDW memDW, cl</code>	<code>ror [dword bx], cl</code>
<code>ror regDW memDW, immB</code>	<code>ror ecx, 4</code>

Sample Code

```
mov cl, 8                ; Load count into cl
ror ax, cl              ; Rotate ax right 8 times
                        ; (Note: this is the same
                        ; as xchg ah, al!)
```

Description

Use `ror` to rotate the bits in word, byte, and doubleword (80386/486 only) registers and memory values to the right (toward the LSDs). The old LSD shifts into the new MSD position while all other bits shift one position to the right. In addition, the old LSD is copied into `cf`. Repeating this action would eventually restore the original value, but not necessarily restore `cf`. (This is nearly identical to the way `rol` operates, except that `cf` is not treated as an extra bit in the rotated value.)

For all processors, the second operand specifies the number of bit rotations to perform. On the 8086 and 8088 processors, if the second operand is literal, it must equal 1. To rotate more than 1 bit, you must assign the rotation count to `cl` and specify this register as the second operand. The 80286 and 80386/486 processors allow you to use any immediate value as the second operand, for example as in `ror ah, 4` to rotate `ah` 4 bits right. The 80386/486 further extends these forms by allowing rotations involving 32-bit extended registers.

When the second operand is an immediate 1, after `ror` the `of` flag equals the exclusive OR of the two MSDs of the newly rotated value. Thus, if `of = 1` after `ror reg | mem, 1`, then the original LSD and MSD bits were different; otherwise, these two end bits in the value were both equal to 1 or 0. In all other cases, when the second operand to `ror` is not an immediate 1, the `of` flag is not defined. Also, if the rotation count is 0, `of` and `cf` are left unchanged—an oddity of little practical value. Of more use

might be the associated fact that, after every ror, cf equals the MSD of the newly rotated value.

See Also rcl, rcr, rol, sal, sar, shl, shr

sahf

Store ah Register to Flags

Processor:	8086/88	80286	80386/486	Flags:	of	df	if	tf	sf	zf	af	pf	cf
	▲	▲	▲		-	-	-	-	▲	▲	▲	▲	▲

Purpose Copies bits 7, 6, 4, 2, and 0 from ah to the marked flags.

Syntax/Example `sahf no operands` `sahf`

Sample Code `xor ah, ah` ; Zero ah
`sahf` ; Zero sf, zf, af, pf, cf

Description Execute `sahf` to store bits from ah into five flags. With bit numbers in parentheses, the affected flags are sf(7), zf(6), af(4), pf(2), and cf(0). Other flags are not affected. The instruction is sometimes used in conjunction with a math coprocessor.

See Also lahf

sal

Shift Arithmetic Left

Processor:	8086/88	80286	80386/486	Flags:	of	df	if	tf	sf	zf	af	pf	cf
	▲	▲	▲		▲u	-	-	-	▲	▲	u	▲	▲

Purpose Shifts bits leftward.

Syntax/Example `sal regB | memB, 1` `sal [abyte], 1`
`sal regB | memB, cl` `sal ax, cl`
`sal regW | memW, 1` `sal dx, 1`
`sal regW | memW, cl` `sal [aword + bx], cl`

80286, 80386/486 only

`sal regB | memB, immB` `sal cx, 8`
`sal regW | memW, immB` `sal [word bp + 4], 4`

80386/486 only

`sal regDW | memDW, 1` `sal edx, 1`
`sal regDW | memDW, cl` `sal [dword es:di], cl`
`sal regDW | memDW, immB` `sal [dword bx], 4`

Sample Code

```

DATASEG
value dd 12345678                      ; A doubleword value
CODESEG
CODESEG                                ; to be multiplied by 2
shl [word value], 1                    ; Shift-low order word
rcl [word value + 2], 1                ; Shift high-order word
jc Exit                                 ; Jump if overflow detected

```

Description

The `sal` and `shl` mnemonics are synonyms for the same instruction and generate the identical machine code. Normally, you'll use `sal` to multiply unsigned values by powers of 2 and `shl` to simply shift bits left into position. Using `sal` lends additional clarity to a program by indicating a mathematical shift, but you can use the two mnemonics interchangeably.

Executing `sal` or `shl` shifts the old MSD of the value into the carry flag. A zero bit shifts into the new LSD. Repeating this action eventually sets all bits in the specified register or memory location to 0.

When the second operand is an immediate 1, after shifting, `of = 1` only if the new `cf` does not equal the new MSD. If `of = 0`, then the new `cf` and MSD bits are different. You might use this knowledge to detect a zero bit shifting into the MSD position of an initially nonzero value. When the second operand is not an immediate 1, `of` is not defined.

The sample shows how to use word shifts and rotations (see `rc1`) to multiply a doubleword value by 2. The initial `shl` shifts the low-order word, copying the MSD into `cf`. Then, `rc1` rotates the high-order word, shifting in `cf` to the new LSD (of the high-order word). Subsequent `rc1` instructions could be added to shift even larger multibyte values. If after the final `rc1` the carry flag equals 1, then an overflow has occurred.

See Also

`rc1`, `rcr`, `rol`, `ror`, `sar`, `shl`, `shr`

sar

Shift Arithmetic Right

Processor:	8086/88	80286	80386/486	Flags:	of	df	if	tf	sf	zf	af	pf	cf
	▲	▲	▲		▲u	-	-	-	▲	▲	u	▲	▲
Purpose	Shifts bits rightward.												
Syntax/Example	<pre> sar regB memB, 1 sar b1, 1 sar regB memB, cl sar ch, cl sar regW memW, 1 sar [aword], 1 sar regW memW, cl sar [word bx], cl 80286, 80386/486 only sar regB memB, immB sar [byte bp + 2], 4 sar regW memW, immB sar dx, 4 80386/486 only sar regDW memDW, 1 sar [dword bp - 8], 1 sar regDW memDW, cl sar eax, cl sar regDW memDW, immB sar edx, 16 </pre>												

Sample Code

```

DATASEG
value dw 08000h    ; -32,768
CODESEG
mov cl, 4          ; Assign shift count to cl
sar [value], cl    ; Value = -2048 (-32,768/16)

```

Description

Unlike `sal` and `shl`, which are synonyms, `sar` is *not* a synonym for `shr`. This often confuses people, but there's a good reason for the apparent discrepancy. The `sar` instruction shifts a register or memory value to the right, copying the old LSD bit into `cf`, but, unlike `shr`, `sar` *does not alter the old MSD bit*. By this action, the original sign of the shifted value remains unchanged; therefore, you can use `sar` to divide signed integers by powers of 2, while `shr` can divide only unsigned integers. The sample demonstrates how this works, using `sar` to divide $-32,768$ by 16, or 2.

When the second operand to `sar` is an immediate 1, or is set to 0. When the second operand is not an immediate 1, the effect on `of` is not defined.

When using `sar` to divide signed negative values in two's complement form by powers of 2, be aware that -1 (0FFFFh, for example) divided by 2 equals -1 , not 0. Some references refer to this effect as "truncation toward negative infinity," suggesting that `sar` does not generate the same answers in all cases as `idiv` by powers of 2, which gives 0 for $-1/2$ (that is, "truncation toward zero").

See Also `rcl`, `rcr`, `rol`, `ror`, `sal`, `shl`, `shr`

sbb

Subtract Integers with Borrow

Processor:	8086/88	80286	80386/486	Flags:	of	df	if	tf	sf	zf	af	pf	cf
	▲	▲	▲		▲	-	-	-	▲	▲	▲	▲	▲

Purpose Subtracts integers, taking a possible borrow from a previous `sub` or `sbb` into account.

Syntax/Example

<code>sbb al, immB</code>	<code>sbb ax, 8</code>
<code>sbb ax, immW</code>	<code>sbb ax, 256</code>
<code>sbb regB memB, immB</code>	<code>sbb [byte bx], 4</code>
<code>sbb regW memW, immW</code>	<code>sbb [word si], 600</code>
<code>sbb regW memW, immB</code>	<code>sbb dx, 3</code>
<code>sbb regB memB, regB</code>	<code>sbb ah, al</code>
<code>sbb regW memW, regW</code>	<code>sbb dx, ax</code>
<code>sbb regB, regB memB</code>	<code>sbb cl, [byte bp + 4]</code>
<code>sbb regW, regW memW</code>	<code>sbb ax, bx</code>

80386/486 only

```
sbb eax, immDW           sbb eax, 35
sbb regDW | memDW, immB sbb ecx, 4
sbb regDW | memDW, immDW sbb [dword bx], 18
sbb regDW | memDW, regDW sbb [dword bx + si], eax
sbb regDW, regDW | memDW sbb edx, [dword bp + 6]
```

Sample Code

```
DATASEG
v1 dd 87654321           ; A doubleword value
v2 dd 12345678           ; Value to subtract from v1
CODESEG
mov ax, [word v2]       ; Get low word of v2
mov dx, [word v2 + 2]   ; Get high word of v2
sub [word v1], ax       ; Subtract low words
sb [word v1 + 2], dx    ; Subtract high words with borrow
```

Description

After a sub or sbb on multibyte, word, or doubleword (80386/486 only) values, use sbb to subtract the higher-order portions of the values, taking a possible borrow into account. When you are not subtracting multipart values this way, always use sub instead, which does not take a borrow into account.

Usually, sbb is used as in the sample to subtract two large integers, in this case two doubleword values labeled v1 and v2. First, the program loads ax and dx with the value of v2. Then sub subtracts the low-order words and sbb finishes the subtraction, subtracting the high-order words and taking a possible borrow from sub into account. (Note: Doubleword values can be subtracted directly on 80386/486 systems.)

See Also

sub

Scan String

scas scasb scasd scasw

Processor:	8086/88	80286	80386/486	Flags:	of	df	if	tf	sf	zf	af	pf	cf
	▲	▲	▲		▲	-	-	-	▲	▲	▲	▲	▲

Purpose Scans a string to search for specific values.

Syntax/Example

```
scas memB           scas [byte di]
scas memW           scas [word string]
scasb no operands scasb
scasw no operands scasw
```

80386/486 only

```
scas memDW         scas [dword string]
scasd no operands scasd
```

Sample Code

```

DATASEG
string db '2Bh or not 2Bh' ; A string
strlen = $ - string ; String length
CODESEG
mov ax,@data ; Initialize es
mov es,ax ; to address data segment
ASSUME es:DGROUPE ; Tell tasm where es points
mov di, offset string; Address string with es:di
mov cx, strlen ; Assign length to cx
mov al, ' ' ; Assign search value to al
repne scasb ; Scan for first blank
;----- di now addresses the "o" in "or"

```

Description

As with all string instructions, register assignments are fixed for `scas` and the shorthand equivalent forms `scasb`, `scasd` (80386/486 only), and `scasw`. The instruction subtracts a byte, word, or doubleword value addressed by `es:di` and is usually used with repeat prefixes `repe` and `repne` to scan variables for specific values. Like `cmp`, the result of the subtraction is discarded—only the flags are retained. Byte values are subtracted from `al`; word values, from `ax`. On 80386/486 systems, doubleword values addressed by either `es:di` or `es:edi` are subtracted from `eax`. A segment override is not allowed; therefore, the string values must be stored in the segment addressed by `es`. After `scas`, if `df = 0`, then `di` (or `edi`) is incremented by the size of the specified operand—by 1 for bytes, 2 for words, and 4 for doublewords. If `df = 1`, then `di` (or `edi`) is decremented by the operand size.

The sample uses `scasb` to scan a character string, looking for the first blank character. After this code executes, if `cx` equals 0, then no blanks were found. To search for the first character *not* matching the value in `al`, you would use the `repe` repeat prefix instead of `repne`.

See Also

`cmpsb`, `cmpsd`, `cmpsw`, `ins`, `insb`, `insd`, `insw`, `lods`, `lodsb`, `lodsd`, `lodsw`, `movs`, `movsb`, `movsd`, `movsw`, `outs`, `outsb`, `outsd`, `outsw`, `stos`, `stosb`, `stosd`, `stosw`

set-condition

Set Byte Conditionally

Processor: 8086/88 80286 80386/486 Flags: of df if tf sf zf af pf cf

**Purpose**

Stores a byte value to a register or to memory if the specified condition is true (byte stored = 1) or false (byte stored = 0).

Syntax/Example

`setcondition regB | memB setae al`

Sample Code

```

DATASEG
bits db 01101001b    ; Packed bits in a byte
bytes db 8 dup (?)   ; Eight bytes
CODESEG
P386
mov bx, offset bytes; Address bytes with ds:bx
mov ah, [bits]       ; Load packed bits into ah
mov cx, 8            ; Assign loop count to cx
@@10:
shl ah, 1           ; Shift 1 bit into cf
setc [byte bx]      ; Set or reset unpacked byte
inc bx              ; Address next byte
loop @@10           ; cx <- cx - 1; jump if cx <> 0

```

Description

On 80386/486 systems, follow a `cmp` instruction with any of the *set-condition* instructions listed in Table 16.5. You can also use these instructions after `test` or any other code that affects various flags. If the condition specified in the center column of the table is met according to the flag settings listed to the right, then the destination byte register or memory value is set to 1, indicating “true”; otherwise, the destination is set to 0. These conditions mirror those supported by the conditional jump instructions (see *j-condition* in this chapter) except for `jcxz` and `jecxz`, which have no equivalent *set-condition* instructions.

The sample demonstrates how to use `setc` to unpack the bits in a byte. On each pass through the loop, if the `shr` instruction shifts a 1 into `cf`, then `setc` sets the byte at `[bx]` to 1; otherwise, `setc` resets the byte to 0. After this loop finishes, the uninitialized bytes variable holds the eight values: 00 01 01 00 01 00 00 01.

See Also*j-condition***Table 16.5. Conditional set-condition Reference.**

<i>Instruction</i>	<i>Set byte to 1 if...else set byte to 0</i>	<i>Flags</i>
<code>seta</code>	above	(<code>cf = 0</code>) & (<code>zf = 0</code>)
<code>setae</code>	above or equal	(<code>cf = 0</code>)
<code>setb</code>	below	(<code>cf = 1</code>)
<code>setbe</code>	below or equal	(<code>cf = 1</code>) (<code>zf = 1</code>)
<code>setc</code>	carry	(<code>cf = 1</code>)
<code>sete</code>	equal	(<code>zf = 1</code>)
<code>setg</code>	greater	(<code>sf = of</code>) & (<code>zf = 0</code>)
<code>setge</code>	greater or equal	(<code>sf = of</code>)
<code>setl</code>	less	(<code>sf <> of</code>)

continues

Table 16.5. continued

<i>Instruction</i>	<i>Set byte to 1 if...else set byte to 0</i>	<i>Flags</i>
setle	less or equal	(sf <> of) (zf = 1)
seto	overflow	(of = 1)
setp	parity	(pf = 1)
setpe	parity even	(pf = 1)
setpo	parity odd	(pf = 0)
sets	sign	(sf = 1)
setz	zero	(zf = 1)
setna	not above	(cf = 1) (zf = 1)
setnae	not above or equal	(cf = 1)
setnb	not below	(cf = 0)
setnbe	not below or equal	(cf = 0) & (zf = 0)
setnc	not carry	(cf = 0)
setne	not equal	(zf = 0)
setng	not greater	(sf <> of) (zf = 1)
setnge	not greater or equal	(sf <> of)
setnl	not less	(sf = of)
setnle	not less or equal	(sf = of) & (zf = 0)
setno	not overflow	(of = 0)
setnp	not parity	(pf = 0)
setns	not sign	(sf = 0)
setnz	not zero	(zf = 0)

shl

Shift Left

Processor: 8086/88 80286 80386/486 Flags: of df if tf sf zf af pf cf
 ▲ ▲ ▲ ▲u - - - ▲ ▲ u ▲ ▲

Purpose Shifts bits leftward.

Syntax/Example `shl regB | memB, I` `shl [abyte], 1`
`shl regB | memB, cl` `shl ax, cl`
`shl regW | memW, I` `shl dx, 1`
`shl regW | memW, cl` `shl [aword + bx], cl`

The sample shows a typical use for `shld`. Two doubleword values `v1` and `v2` form a 64-bit variable in memory. Only four instructions are required to shift this variable left by any number of bits (up to 31)–8 in this sample. First, the shift count is loaded into `c1`. Then the second part of the value is loaded into `eax`. The `shld` instruction shifts the bits from `eax` into the doubleword value [`v1`], which also shifts to the left an equal number of times. The `shl` instruction finishes the shift by shifting [`v2`] by the same count in `c1`. The effect is to multiply in a very short time the full 64-bit double-precision value by 2^8 (256 decimal).

See Also

`shrd`

shr

Shift Right

Processor:	8086/88	80286	80386/486	Flags:	of	df	if	tf	sf	zf	af	pf	cf	
	▲	▲	▲		▲	u	-	-	-	▲	▲	u	▲	▲

Purpose

Shifts bits rightward.

Syntax/Example

```
shr regB | memB, 1      shr [abyte], 1
shr regB | memB, cl     shr ax, cl
shr regW | memW, 1      shr dx, 1
shr regW | memW, cl     shr [aword + bx], cl
```

80286, 80386/486 only

```
shr regB | memB, immB  shr cx, 8
shr regW | memW, immB  shr [word bp + 4], 4
```

80386/486 only

```
shr regDW | memDW, 1   shr edx, 1
shr regDW | memDW, cl  shr [dword es:di], cl
shr regDW | memDW, immB shr [dword bx], 4
```

Sample Code

```
mov ax, 10500 ; Assign value to ax
mov cl, 3     ; Assign shift count to cl
shr ax, cl    ; Divide 10500 by 8 (ax = 1312)
```

Description

Executing `shr` shifts the old LSD of a byte, word, or doubleword (80386/486 only) value into the carry flag. A zero bit shifts into the new MSD. Repeating this action will eventually set all bits in the specified register or memory location to 0. Be aware that `shr` and `sar` are not synonyms, despite the fact that the counterpart instructions `sal` and `shl` are synonyms. (See these other instructions for more details.)

When the second operand to `shr` is an immediate 1, of is set to the MSD of the original value. When the second operand is not an immediate 1, the effect on of is not defined.

The sample demonstrates a common use for `shr`, dividing unsigned values by powers of 2. First, a value is loaded into `ax`, and the shift count is assigned to `cl`. Then `shr` shifts `ax` right by the number of times specified in `cl`. The result equals 10,500 divided by 2^3 , or 1,312 dropping the remainder.

See Also `rcl`, `rcr`, `rol`, `ror`, `sal`, `sar`, `shl`

shrd

Double-Precision Shift Right

Processor:	8086/88	80286	80386/486	Flags:	of	df	if	tf	sf	zf	af	pf	cf
			▲	u	-	-	-	▲	▲	u	▲	▲	

Purpose Shifts bits of multiple values rightward.

Syntax/Example

<code>shrd regW memW, regW, immB</code>	<code>shrd [bx], ax, 3</code>
<code>shrd regDW memDW, regDW, immB</code>	<code>shrd [edi], edx, 4</code>
<code>shrd regW memW, regW, cl</code>	<code>shrd ax, bx, cl</code>
<code>shrd regDW memDW, regDW, cl</code>	<code>shrd eax, ebx, cl</code>

Sample Code

```
shrd ecx, ecx, 4 ; Shift bits in four
shrd ecx, ebx, 4 ; general-purpose
shrd ebx, eax, 4 ; registers by 4
shr  eax, 4
```

Description On 80386/486 systems, use `shlr` to shift double-precision values to the right. The first operand specifies the destination and may be a word or doubleword register or memory reference. The second operand specifies the source bits that are shifted into the first operand. This value must be a word or doubleword register. The third operand specifies the number of shifts to perform and may be an immediate value from 0 to 31 or a value in register `cl`. Values greater than 31 are treated modulo 32.

You can use `shrd` to divide multiple-precision values by powers of 2. The sample demonstrates this idea by shifting 4 times left a 128-bit (16-byte) value held in registers `eax`, `ebx`, `ecx`, and `edx` with the highest-order portion of the value in `eax`. This divides the multiple-precision value by 2^4 , or 16. For more information, read the notes to `shld`, which operates identically to `shrd` except for the direction of the shift.

See Also `shld`

stc

Set Carry Flag

Processor:	8086/88	80286	80386/486	Flags:	of	df	if	tf	sf	zf	af	pf	cf
	▲	▲	▲	-	-	-	-	-	-	-	-	-	1

Purpose Sets the carry flag to 1.

Syntax/Example `stc no operands stc`

Sample Code

```

PROC AnyProc
; Procedure code
@@ErrExit:
    stc      ; Set carry (error)
    ret     ; Return to caller
@@NoErrExit:
    clc     ; Clear carry (no error)
    ret     ; Return to caller
ENDP AnyProc

```

Description Executing `stc` sets the carry flag to 1. As the sample code demonstrates, the instruction is often used to pass an error flag back from a subroutine, setting `cf` if an error was detected. (This is the same example shown for `clc`.)

See Also `clc`, `cmc`

std

Set Direction Flag

Processor:	8086/88	80286	80386/486	Flags:	of	df	if	tf	sf	zf	af	pf	cf
	▲	▲	▲		-	1	-	-	-	-	-	-	-

Purpose Sets the direction flag to 1.

Syntax/Example `std no operands std`

Sample Code

```

DATASEG
string db 10 dup (?)
strlen = $ - string
CODESEG
    mov ax,@data      ; Initialize es to address
    mov es,ax         ; of data segment
    ASSUME es:DGROUP ; Tell tasm where es points
    mov cx, strlen    ; Assign string length to cx
    mov di, offset string + strlen - 1 ; di addresses string end
    std               ; Auto-decrement di
@@10:
    mov al, cl        ; Assign next value to al
    stos [string]    ; Store al in string
    loop @@10        ; cx <- cx - 1; jump if cx <> 0

```

Description Use `std` to set the direction flag to 1. Always execute `std` (or the companion instruction `cld`) before a repeated string operation, which decrements either or both `si` and `di` automatically if `df` = 1. The sample demonstrates how to use `std` after first initializing `cx` to the length of a 10-byte string variable and addressing the end of the string with `es:di`. The three-instruction loop assigns successive values to `al`, which `stos` stores in the string, also decrementing `di` automatically because `df` = 1. The effect is to set `string` to the ten values 1, 2, ..., 10.

See Also `cld`

sti**Set Interrupt-Enable Flag**

Processor:	8086/88	80286	80386/486	Flags:	of	df	if	tf	sf	zf	af	pf	cf
	▲	▲	▲		-	-	1	-	-	-	-	-	-

Purpose Sets interrupt-enable flag to 1.

Syntax/Example `sti no operands sti`

Sample Code

```
cli      ; Disable maskable interrupts
;
; Code runs with maskable interrupts disabled
;
sti      ; Enable maskable interrupts again
```

Description Executing `sti` sets the interrupt-enable flag `if` to 1, allowing the processor to recognize maskable interrupts. The instruction is commonly used as one of the first commands in an interrupt service routine, which begins running with `if = 0`. Setting `if` to 1 with `sti` allows interrupts to be recognized during execution of the ISR.

See Also `cli`

stos stosb stosd stosw**Store String**

Processor:	8086/88	80286	80386/486	Flags:	of	df	if	tf	sf	zf	af	pf	cf
	▲	▲	▲		-	-	-	-	-	-	-	-	-

Purpose Stores strings of values into memory.

Syntax/Example

```
stos memB      stos [byte destination]
stos memW      stos [word destination]
stosb no operands stosb
stosw no operands stosw
```

80386/486 only

```
stos memDW     stos [dword destination]
stosd no operands stosd
```

Sample Code

```
DATASEG
buffer db 512 dup (0ffh)
CODESEG
mov ax,@data      ; Initialize es to address
mov es,ax         ; of data segment
ASSUME es:DGROUP ; Tell tasm where es points
mov di, offset buffer ; Address buffer with es:di
mov cx, 512 / 2   ; Assign buffer size / 2 to cx
xor ax, ax       ; Set ax to 0000
cld              ; Auto-increment di
rep stosw       ; Fill buffer with 00 words
```

Description

Use `stos` or the equivalent shorthand mnemonics `stosb`, `sstosd` (80386/486 only), and `stosw` to store strings of values in memory. Like all string instructions, register assignments are fixed even if you specify an explicit address label as the operand to `stos`. (The shorthand mnemonics do not require operands.) The instruction stores the value of `al`, `ax`, or `eax` (80386/486 only) to the location addressed by `es:di`. The size of the value stored depends on the size of the specified operand, unless you choose a shorthand mnemonic—`stosb` to store bytes, `stosw` to store words, and `sstosd` to store 80386/486 doublewords. After the instruction executes, if `df = 0`, `di` is incremented by the size of the value stored—by 1 for bytes, 2 for words, or 4 for doublewords. If `df = 1`, then `di` is decremented by this amount. Usually, `stos` is used with the `rep` repeat prefix along with a count value in `cx` to store values in multiple locations. As the sample demonstrates, this provides a fast and easy way to fill memory blocks with values, in this case, initializing a 512-byte buffer with zeros. Because the buffer size (512) is evenly divisible by 2, `stosw` is used instead of `stosb`, repeating for 256 instead of 512 times.

See Also

`cmpsb`, `cmpsd`, `cmpsw`, `ins`, `insb`, `insd`, `insw`, `lods`, `lodsb`, `lodsd`, `lodsw`, `movs`, `movsb`, `movsd`, `movsw`, `outs`, `outsb`, `outsd`, `outsw`, `scas`, `scasb`, `scasd`, `scasw`

sub

Subtract

Processor:	8086/88	80286	80386/486	Flags:	of	df	if	tf	sf	zf	af	pf	cf
	▲	▲	▲		▲	–	–	–	▲	▲	▲	▲	▲
Purpose	Subtracts integers.												
Syntax/Example	<code>sub al, immB</code> <code>sub ax, immW</code> <code>sub regB memB, immB</code> <code>sub regW memW, immW</code> <code>sub regW memW, immB</code> <code>sub regB memB, regB</code> <code>sub regW memW, regW</code> <code>sub regB, regB memB</code> <code>sub regW, regW memW</code>			<code>sub al, 3</code> <code>sub ax, 1000</code> <code>sub dl, 5</code> <code>sub [word bx], 256</code> <code>sub bx, 8</code> <code>sub [byte es:di], dl</code> <code>sub cx, cx</code> <code>sub ah, al</code> <code>sub dx, [word bp + 4]</code>									
	80386/486 only												
	<code>sub eax, immDW</code> <code>sub regDW memDW, immB</code> <code>sub regDW memDW, immDW</code> <code>sub regDW memDW, regDW</code>			<code>sub eax, 164532</code> <code>sub [dword bp - 8], 2</code> <code>sub edx, 99999</code> <code>sub [dword array + bx + di], edi</code> <code>sub edi, ecx</code>									

Sample Code

```

DATASEG
v1 dd 155612      ; A doubleword value
v2 dd 35996       ; Value to subtract from v1
CODESEG
mov ax, [word v2] ; Load low-order v2 into ax
sub [word v1], ax ; Subtract low-order words
mov ax, [word v2 + 2] ; Load high-order v2 into ax
sbb [word v1 + 2], ax ; Subtract high-order words
    
```

Description Use sub to subtract two signed or unsigned bytes, words, or doublewords (80386/486 only). The second operand is subtracted from the first, replacing the original value of the first operand. The sub instruction typically subtracts two values directly or begins a multiple-precision sequence that subtracts values larger than the maximum register size. When doing this, follow sub with one or more sbb instructions to complete the subtraction and take possible borrows into account. The sample demonstrates how this works, subtracting a doubleword value v2 from another doubleword value v1 and storing the result in v1. (Doublewords can be subtracted directly only on 80386/486 systems.)

See Also sbb

test

Test Bits

Processor:	8086/88	80286	80386/486	Flags:	of	df	if	tf	sf	zf	af	pf	cf
	▲	▲	▲		0	-	-	-	▲	▲	u	▲	0

Purpose Compares values, performing a logical AND.

Syntax/Example

```

test al, immB          test al, 00001000b
test ax, immW          test ax, 000Fh
test regB | memB, immB test [byte bx], 080h
test regW | memW, immW test dx, 01000h
test regB | memB, regB test ah, cl
test regW | memW, regW test ax, cx
    
```

80386/486 only

```

test eax, immDW          test eax, 02h
test regDW | memDW, immDW test [dword bx + di], 04000000h
test regDW | memDW, regDW test edx, ebx
    
```

Sample Code

```

mov ax, -1      ; Load test value into ax
test ax, 08000h ; Does MSD = 1?
jz  @@10       ; Jump if MSD <> 1
neg ax         ; Else find absolute value
@@10:
    
```

Description The test instruction is identical in every way to and except that the result of the logical AND operation is discarded—only the flags are retained, which can be inspected by a conditional jump. The most

xchg

Exchange

Processor: 8086/88 80286 80386 Flags: of df if tf sf zf af pf cf
 ▲ ▲ ▲ - - - - -

Purpose

Exchanges register values with other register and memory values.

Syntax/Example

```
xchg ax, regW                            xchg ax, cx
xchg regW, ax                            xchg bx, ax
xchg regB, regB | memB                 xchg dh, dl
xchg regB | memB, regB                 xchg [byte bp + 4], ah
xchg regW, regW | memW                 xchg ax, bx
xchg regW | memW, regW                 xchg [word bx], dx
```

80386/486 only

```
xchg eax, regDW                         xchg eax, ebx
xchg regDW, eax                         xchg ecx, eax
xchg regDW, regDW | memDW              xchg edx, [dword bx + di]
xchg regDW | memDW, regDW              xchg [dword var], eax
```

Sample Code

```
DATASEG
array db 80 dup (?) ; Addressed by [bx]
arraysize = $ - array ; Size of array
newbx dw offset array ; Place to hold bx
newcx dw arraysize ; Place to hold cx
CODESEG
PROC Outer
call Inner ; Initialize/preserve bx, cx
;
; other code in procedure
;
PROC Inner
xchg bx, [newbx] ; Initialize/restore bx
xchg cx, [newcx] ; Initialize/restore cx
ret ; Return to caller
ENDP Inner
ENDP Outer
```

Description

Use `xchg` to exchange two byte, word, or doubleword (80386/486 only) values, which can be in registers or in memory locations. The two operands—of which at least one must be a register—exchange values without requiring the use of an intermediate value on the stack or in another register. The sample uses `xchg` to initialize and save the values of two registers `bx` and `cx`. The `call` to `Inner` at the beginning of the `Outer` procedure swaps the registers with two word variables. When the procedure finishes, the code falls through to `Inner`, again executing the two `xchg` instructions before returning to `Outer`'s caller, thus restoring `bx` and `cx` to their original values, while storing the registers' *current* values. Later, when the procedure is again called, `bx` and `cx` will be loaded with the values they had at

the end of the procedure's previous run, allowing the code to pick up where it left off.

Trivia department: The special form `xchg ax, ax` generates the identical machine code as a `nop` instruction—the single byte 90h.

See Also

`bswap`, `cmpxchg`, `lock`, `nop`, `xadd`

xlat xlatb

Translate From Table

Processor:	8086/88	80286	80386/486	Flags:	of	df	if	tf	sf	zf	af	pf	cf
	▲	▲	▲		-	-	-	-	-	-	-	-	-

Purpose

Looks up (translates) a byte value from a table.

Syntax/Example

```
xlat memB      xlat [es:table]
xlatb no operands xlatb
```

Sample Code

```
DATASEG
table db 120, 202, 100, 64, 98, 250, 14, 8
CODESEG
mov al, 3          ; Load index into al
mov bx, offset table ; Address table with ds:bx
xlatb              ; Sets al to 64
```

Description

The `xlat` instruction translates a value in `al` to an associated value from a table of bytes. The table must be addressed by `ds:bx` or, using an `es`: override, by `es:bx`. The value in `al` represents an index into the table with the first table byte having the index value 0. Executing `xlat` loads the byte at `ds:bx + al` or `es:bx + al` into `al`. The sample demonstrates how this works; it loads `al` with the fourth byte (index = 3) from a small table, setting `al` to 64.

The plain `xlat` instruction does not require an operand. If you add an operand, it may refer to `bx` as in `xlat [bx]` and `xlat [es:bx]`, or it may refer to the table by name as in `xlat [table]` and `xlat [es:table]`. No matter what form you choose, however, you still have to load `bx` with the offset address of the table—the instruction doesn't do this for you. The shorthand form `xlatb`, which performs identically to `xlat`, may not be used with an operand.

Some references suggest using `lea` to load `bx` with the effective address of a table element. For example, you could use the instruction `lea bx, [matrix + si]` to initialize `bx` to the offset address of two-dimensional matrix row indexed by `si` and then use `xlat` to translate a column index in `al` to one of the bytes from that row. Another typical use for `xlat` is to translate ASCII characters to alternate symbols, perhaps to allow people to reprogram keyboards or to convert values to different character-set encodings.

See Also

`lea`

XOR

Exclusive OR

Processor:	8086/88	80286	80386/486	Flags: of	df	if	tf	sf	zf	af	pf	cf
	▲	▲	▲	0	-	-	-	▲	▲	u	▲	0

Purpose Logically exclusive ORs two byte, word, or doubleword (80386 only) values.

Syntax/Example

xor <i>al</i> , <i>immB</i>	xor <i>al</i> , 0FFh
xor <i>ax</i> , <i>immW</i>	xor <i>ax</i> , 08000h
xor <i>regB</i> <i>memB</i> , <i>immB</i>	xor [byte <i>bx</i>], 01h
xor <i>regW</i> <i>memW</i> , <i>immW</i>	xor <i>cx</i> , 0400h
xor <i>regW</i> <i>memW</i> , <i>immB</i>	xor [word <i>bp</i> + 2], 10h
xor <i>regB</i> <i>memB</i> , <i>regB</i>	xor <i>ah</i> , <i>cl</i>
xor <i>regW</i> <i>memW</i> , <i>regW</i>	xor <i>dx</i> , <i>cx</i>
xor <i>regB</i> , <i>regB</i> <i>memB</i>	xor <i>ah</i> , [byte <i>bx</i>]
xor <i>regW</i> , <i>regW</i> <i>memW</i>	xor <i>dx</i> , <i>dx</i>

80386/486 only

xor <i>eax</i> , <i>immDW</i>	xor <i>eax</i> , 00400000h
xor <i>regDW</i> <i>memDW</i> , <i>immDW</i>	xor <i>edx</i> , 0FFFFFFFh
xor <i>regDW</i> <i>memDW</i> , <i>immB</i>	xor [dword <i>bx</i>], 01h
xor <i>regDW</i> <i>memDW</i> , <i>regDW</i>	xor <i>eax</i> , <i>eax</i>
xor <i>regDW</i> , <i>regDW</i> <i>memDW</i>	xor <i>edx</i> , [dword <i>bx</i> + <i>si</i>]

Sample Code

```
xor ax, ax ; Sets ax to 0000
xor bx, 0FFFFh ; Forms one's complement of bx
```

Description Use xor to perform the logical exclusive OR operation to two byte, word, or doubleword (80386 only) values. The result of the operation replaces the value of the first operand. The second operand is often referred to as the *mask*. A typical use for xor is to toggle bits on and off, changing ones to zeros and zeros to ones. Also, due to the rules of the exclusive OR, because 1 can only result when the two original corresponding bits are different, performing xor on a register with itself sets that register to 0—a common 8086 technique that saves 1 byte. (The instruction mov ax, 0 takes 3 bytes; xor ax, ax takes 2.)

See Also and, or, not

17

CHAPTER

Turbo Assembler Reference

- Symbols, 788
- Operators, 792
- Mode Equivalents, 795
- Directives, 797

Symbols

Table 17.1 describes various italicized symbols used throughout this chapter while Table 17.2 describes in more detail the symbols for *warnclass*. The predefined symbols in Turbo Assembler are detailed in Table 17.3.

Table 17.1. Symbols and Meanings.

<i>Symbol</i>	<i>Meaning</i>
	either or
[]	optional*
...	a numeric series or continuation
[]...	a repeating optional element
::=	is equivalent to
<i>align</i>	byte word dword para page
<i>argument</i>	macro parameters
<i>boundary</i>	a power of 2 (e.g., 2, 4, 8)
<i>class</i>	<i>text</i> representing a segment classification
<i>codesym</i>	a code symbol (i.e., a label)
<i>columns</i>	number of columns
<i>combine</i>	at <i>expr</i> common memory private public stack
<i>condition</i>	expression evaluating to true (<> 0) or false (=0)
<i>count</i>	1, 2, ..., 65535
<i>datasym</i>	a data symbol (i.e., a label)
<i>definition</i>	a directive element defined in the directive syntax
<i>distance</i>	near far
<i>dx</i>	db dd df dp dq dt dw
<i>entry point</i>	a code label defining the start of a program
<i>expr</i>	numeric expression
<i>fieldname</i>	name of a record field name
<i>fields</i>	any data allocation created by db, dw, etc.
<i>filename</i>	a file name with or without path and drive information
<i>groupname</i>	name of a multiple segment group
<i>language</i>	basic c fortran pascal prolog

<i>Symbol</i>	<i>Meaning</i>
<i>macroname</i>	name of a defined macro
<i>memorymodel</i>	tiny small medium compact large huge tpascal
<i>memref</i>	memory reference
<i>name</i>	an identifier such as MyData or YourCode
<i>parameter</i>	a replaceable dummy parameter
<i>prefix</i>	two-character local label prefix, normally @@
<i>recordname</i>	name of a record data type
<i>register</i>	ax bx cx di ds dx es si (80386/486 only:) eax ebx ecx edi edx esi
<i>rows</i>	number of rows
<i>segexpr</i>	SEG <i>expr</i> (see SEG operator)
<i>segmentname</i>	name of a segment
<i>segname</i>	segreg segmentname segexpr
<i>segreg</i>	cs ds es ss
<i>size</i>	a whole number constant
<i>statements</i>	assembly language instructions or directives
<i>structname</i>	name of a structure
<i>text</i>	any sequence of characters
<i>type</i>	near far proc byte word dataptr dword fword pword qword tbyte <i>structname</i>
<i>use</i>	use16 use32
<i>version_id</i>	M400—(MASM 4.0) M500—(MASM 5.0) M510— (MASM 5.1) M520—(MASM 5.2 aka Quick ASM) T100—(TASM 1.0) T101—(TASM 1.01) T200— (TASM 2.0) T250—(TASM 2.5) T300—(TASM 3.0) T310—(TASM 3.1) T320—(TASM 3.2) T400— (TASM 4.0)
<i>warnclass</i>	aln ass brk icg lco opi opp ops ovf pdc pqk pro res tpi (See Table 17.2.)
<i>width</i>	a whole number constant

*Don't confuse the square brackets [], which surround optional items, with the square brackets used in a program's indirect memory references as in `mov ax, [count]`.

Table 17.2. Symbols for warnclass.

<i>Symbol</i>	<i>Meaning</i>
aln	segment alignment
ass	assumes 16-bit segment
brk	brackets needed
icg	inefficient code generation
gtp	global and symbol type mismatch
int	interrupt 3 (int 3) generation
lco	location counter overflow
mcp	MASM compatibility pass
opi	open IF conditional
opp	open procedure
ops	open segment
ovf	arithmetic overflow
pdv	pass-dependent construction
pqk	assuming constant for [const]
pro	protected-mode memory-write needs cs: override
res	reserved word
tpi	Turbo Pascal illegal construction
uni	uninitialized segment warning off

Table 17.3. Turbo Assembler Predefined Symbols.

<i>Symbol</i>	<i>Type</i>	<i>Description</i>
@32Bit	numeric	Segment model; 0 = 16-bit, 1 = 32-bit
@Code	alias	Code segment name
@CodeSize	numeric (byte)	0 = small, compact model; 1 = other models

<i>Symbol</i>	<i>Type</i>	<i>Description</i>
@Cpu	numeric (word)	Enabled processor instructions; bit numbers (1 = on, 0 = off): 0-8086; 1-80186; 2-80286; 3-80386; 4-80486; 5-80586; 6-unused; 7-protected mode; 8-8087; 9-unused; 10-80287; 11-80387; 12, 13, 14, 15-unused
@CurSeg	alias	Current segment name
@Data	alias	Near data segment name
@DataSize	numeric (byte)	Data memory model: 0 = tiny, small, medium; 1 = compact; 2 = huge
@FarData	alias	Far data segment name
@FarData?	alias	Far uninitialized data segment name
@FileName	alias	Assembly file name as an equated symbol
@Interface	numeric	Language or operating system; bit numbers: 0—no language; 1—C; 2—SysCal; 3—StdCall; 4—Pascal; 5—Fortran; 6—Basic; 7—Prolog; 8—C++. Bit 7 represents DOS/Windows (0) or Windows NT (1) if another language bit is also on
@Object	alias	Name of current object
@Stack	alias	Segment or group assumed for register ss
@Startup	alias	Near label marking start of program using the STARTUPCODE directive
@Table_<object-name>	alias	Table data type that contains an object's method table

continues

Table 17.3. continued

<i>Symbol</i>	<i>Type</i>	<i>Description</i>
@Tableaddr_<object-name>	alias	Label for the address of an object's virtual method table
@WordSize	numeric (byte)	Segment address size: 2 = 16 bit; 4 = 32 bit
??Date	string	Today's date
??FileName	string	Assembly file name as a character string
??Time	string	Current time in DOS country-code format
??Version	numeric (word)	Turbo Assembler version number: high byte = major revision numbers, low byte = minor revision numbers

Note: Equates of type *alias* represent other symbols. For example, @code represents the name of the current code segment—any place you can use a segment name, you can use an alias instead. Numeric equates represent whole number values—use them any place you would use another numeric equate. String equates represent unterminated character strings, which you can insert in `db` directives to create variables containing the file name, date, and time.

Operators

Operators are printed in Table 17.4 in uppercase to make them more visible. In programs, you may write operators in uppercase or lowercase. Table 17.5 lists possible SYMTYPE values. SYMTYPE is equivalent to MASM's `.TYPE` operator (with a leading period). The `TYPE operator` (without a leading period) returns a value as listed in Table 17.6. If positive, `TYPE` represents the *expr* size in bytes. If negative, `TYPE` represents a `NEAR` or `FAR` pointer. Turbo Assembler requires MASM mode to be enabled before using `TYPE`. Despite appearances, `TYPE` is *not* equivalent to MASM's `.TYPE` operator.

Table 17.4. Turbo Assembler Operators.

<i>Symbol</i>	<i>Syntax</i>	<i>Description</i>
()	(<i>expr</i>)	evaluate expression
*	<i>expr</i> * <i>expr</i>	multiply
+	<i>expr</i> + <i>expr</i>	add

<i>Symbol</i>	<i>Syntax</i>	<i>Description</i>
+	<i>+expr</i>	unary plus
-	<i>expr - expr</i>	subtract
-	<i>-expr</i>	unary minus
.	<i>memref.field</i>	structure member separator
/	<i>expr/expr</i>	divide
:	<i>segname groupname:expr</i>	segment override
?	<i>dx?</i>	uninitialized data
[]	<i>[memref]</i>	indirect reference
AND	<i>expr AND expr</i>	logical AND
BYTE	<i>BYTE [PTR] expr</i>	8-bit byte data
CODEPTR	<i>CODEPTR</i>	Procedure address size (2—small models; 4—large models)
DATAPTR	<i>DATAPTR</i>	Data address size (2—small models; 4—large models)
DUP	<i>count DUP (expr[,expr]...)</i>	duplicate
DWORD	<i>DWORD [PTR] expr</i>	32-bit doubleword data
EQ	<i>expr EQ expr</i>	equals
FAR	<i>FAR [PTR] expr</i>	far-code address
FWORD	<i>FWORD [PTR] expr</i>	48-bit far-data pointer
GE	<i>expr GE expr</i>	greater than or equal
GT	<i>expr GT expr</i>	greater than
HIGH	<i>HIGH expr</i>	high order of
LARGE	<i>LARGE expr</i>	force offset to 32 bits
LE	<i>expr LE expr</i>	less than or equal
LENGTH	<i>LENGTH datasym</i>	length of (element count)
LOW	<i>LOW expr</i>	low order of
LT	<i>expr LT expr</i>	less than
MASK	<i>MASK recordname fieldname</i>	bit mask
MOD	<i>expr MOD expr</i>	modulo (division remainder)
NE	<i>expr NE expr</i>	not equal
NEAR	<i>NEAR expr</i>	near code address
NOT	<i>NOT expr</i>	one's complement

Table 17.4. continued

<i>Symbol</i>	<i>Syntax</i>	<i>Description</i>
OFFSET	OFFSET <i>expr</i>	offset address
OR	<i>expr</i> OR <i>expr</i>	logical OR
PROC	PROC <i>codesym</i>	code procedure
PTR	<i>type</i> PTR <i>expr</i>	pointer to
PWORD	PWORD [PTR] <i>expr</i>	far-data pointer
QWORD	QWORD [PTR] <i>expr</i>	64-bit quadword data
SEG	SEG <i>expr</i>	segment address
SHL	<i>expr</i> SHL <i>count</i>	bit shift left
SHORT	SHORT <i>expr</i>	short code address
SHR	<i>expr</i> SHR <i>count</i>	bit shift right
SIZE	SIZE <i>datasym</i>	size in bytes
SMALL	SMALL <i>expr</i>	16-bit small offset
SYMTYPE	SYMTYPE <i>expr</i>	type of symbol (See Table 17.5)
TBYTE	TBYTE [PTR] <i>expr</i>	80-bit tenbyte data
THIS	THIS <i>type</i>	assign current address
TYPE	TYPE <i>expr</i>	size of symbol (See Table 17.6)
UNKNOWN	UNKNOWN <i>expr</i>	remove type information
WIDTH	WIDTH <i>record</i> <i>field</i>	record field bit width
WORD	WORD [PTR] <i>expr</i>	16-bit word data
XOR	<i>expr</i> XOR <i>expr</i>	logical exclusive OR

Table 17.5. Possible SYMTYPE Values.

<i>Bit Number</i>	<i>If bit = 1, then the symbol...</i>
0	belongs to a code segment
1	belongs to a data segment
2	is a constant (i.e., an equate)
3	is a direct memory reference
4	is a register
5	is defined
6	(unused bit)
7	is external to module

Note: If bits 2 and 3 equal 0, then the symbol is an indirect memory reference such as [bx + si]. If all bits equal 0, then the symbol is not defined. (This condition produces an assembly error when using SYMTYPE in data allocation directives such as db and dw.)

Table 17.6. Possible TYPE Values.

<i>Value</i>	<i>Type Represented</i>	<i>Value</i>	<i>Type Represented</i>
0	constant	8	QWORD
1	BYTE	10	TBYTE
2	WORD	0FFFFh	NEAR
4	DWORD	0FFFEh	FAR
6	WORD or PWORD	n	number of bytes in a structure or table or union

Mode Equivalents

The MASM- and Ideal-mode equivalents are listed in Table 17.7.

Table 17.7. MASM- and Ideal-Mode Equivalents.

<i>MASM Mode</i>	<i>Ideal Mode</i>
.186	P186
.286	P286
.286C	P286N

Table 17.7. continued

<i>MASM Mode</i>	<i>Ideal Mode</i>
.286P	P286N
.287	P287
.386	P386
.386C	P386N
.386P	P386N
.387	P387
.486	P486
.486C	P486N
.486P	P486N
.487	P487
.586	P586
.586C	P586N
.586P	P586N
.587	P587
.8086	P8086
.8087	P8087
.ALPHA	DOSSEG
.CODE	CODESEG
COMMENT	(none)
.CONST	CONST
.CREF	%CREF
.DATA	DATASEG
.DATA?	UDATASEG
.ERR	ERR
.ERR1	ERRIF1
.ERR2	ERRIF2
.ERRB	ERRIFB
.ERRDEF	ERRIFDEF
.ERRDIF	ERRIFDIF
.ERRDIFI	ERRIFDIFI
.ERRE	ERRIFE
.ERRIDN	ERRIFDN

<i>MASM Mode</i>	<i>Ideal Mode</i>
.ERRIDNI	ERRIFIDNI
.ERRNB	ERRIFNB
.ERRNDEF	ERRIFNDEF
.ERRNZ	ERRIF
.FARDATA	FARDATA
.FARDATA?	UFARDATA
.LALL	%MACS
.LFCOND	%CONDS
.LIST	%LIST
.MODEL	MODEL
%OUT	DISPLAY
PAGE	%PAGESIZE
.RADIX	RADIX
.SALL	%NOMACS
.SEQ	(none)*
.SFCOND	%NOCONDS
.STACK	STACK
SUBTTL	%SUBTTL
.TFCOND	(none)
TITLE	%TITLE
.TYPE	SYMTYPE†
.XALL	(none)
.XCREF	%NOCREF
.XLIST	%NOLIST

*Turbo Assembler normally collects segments in sequential order as encountered during assembly. With early TASM versions, use the DOSSEG (.ALPHA) directive to collect segments in alphabetic order. DOSSEG is obsolete in TASM 4.0. There is no Ideal-mode equivalent to the MASM .SEQ directive.

†This is an operator. All other symbols in this table are directives.

Directives

Most operators and directives are printed in uppercase in Table 17.8a through 17.8f to make them more visible. In programs, you may write operators and directives in uppercase or lowercase. Only Ideal-mode directives are listed in this table. See Table 17.8a for the equivalent MASM-mode directives.

Table 17.8a. Turbo Assembler 1.0 Directives.

<i>Directive</i>	<i>Name</i>	<i>Syntax</i>
:	Define near-code label	<i>codesym</i> :
=	Define numeric equate	<i>name</i> = <i>expr</i>
ALIGN	Align location counter	ALIGN <i>boundary</i>
ARG	Define procedural arguments	ARG <i>arglist</i> [= <i>name</i>] [RETURNS <i>arglist</i>] <i>arglist</i> ::= <i>definition</i> [, <i>definition</i>]... <i>definition</i> ::= <i>name</i> : <i>typedef</i> <i>typedef</i> ::= <i>type</i> PTR [<i>type</i>] [<i>distance</i> [PTR[<i>type</i>]]]
ASSUME	Set default segment register	ASSUME <i>segreg</i> : <i>segmentname</i> [, <i>segreg</i> : <i>segmentname</i>]... ASSUME <i>segreg</i> :NOTHING [, <i>segreg</i> :NOTHING]... ASSUME NOTHING
%BIN	Set listing object-code field width	%BIN <i>size</i>
CODESEG	Start new code segment	CODESEG [<i>name</i>]
COMM	Define communal variable	COMM <i>definition</i> [, <i>definition</i>]... <i>definition</i> ::= [<i>distance</i>] <i>name</i> : <i>type</i> [: <i>count</i>]
%CONDS	List all conditional statements	%CONDS

Directive

Name

Syntax

CONST

Start of constant data segment

CONST

%CREF

List cross references

%CREF

%CREFALL

List all cross-reference symbols

%CREFALL

%CREFREF

List only referenced symbols in cross reference

%CREFREF

%CREFUREF

List only unreferenced symbols in cross reference

%CREFUREF

%CTLS

List listing controls

%CTLS

DATASEG

Start new data segment

DATASEG

DB

Define byte

[name] DB *expr[,expr]...*

DD

Define doubleword

[name] DD [*type PTR*] *expr[,expr]...*

%DEPTH

Set listing nesting depth level

%DEPTH *size*

DF

Define farword pointer

[name] DF [*type PTR*] *expr[,expr]...*

DISPLAY

Display quoted string during assembly

DISPLAY "*text*"

Table 17.8a. continued

<i>Directive</i>	<i>Name</i>	<i>Syntax</i>
DOSSEG*	Enable standard DOS segment order	DOSSEG
DP	Define far 48-bit pointer	<i>[name]</i> DP [<i>type PTR</i>] <i>expr[,expr]...</i>
DQ	Define quadword	<i>[name]</i> DQ <i>expr[,expr]...</i>
DT	Define ten-byte variable	<i>[name]</i> DT <i>expr[,expr]...</i>
DW	Define word	<i>[name]</i> DW [<i>type PTR</i>] <i>expr[,expr]...</i>
ELSE	Start alternate conditional block	IF <i>condition</i> <i>statements</i>
	ELSE	<i>statements</i>
	ENDIF	
EMUL	Emulate coprocessor instructions	EMUL
END	End of source text	END [<i>entry point</i>]
ENDIF	End of conditional block	IF <i>condition</i> <i>statements</i>
	ENDIF	

Directive

Name

Syntax

ENDP

End of procedure

ENDP *[name]*

ENDS

End of segment or structure

ENDS *[name]*

EQU

Equate symbol (*name*) to value (*expr*)

name EQU *expr*

ERR

Force error message

ERR

ERRIF

Force error if *expr* is true

ERRIF *condition*

ERRIF1

Force error if pass 1

ERRIF1

ERRIF2

Force error if pass 2

ERRIF2

ERRIFB

Force error if argument blank

ERRIFB *argument*

ERRIFDEF

Force error for defined symbol

ERRIFDEF *name*

ERRIFDIF

Force error for different arguments

ERRIFDIF *argument1, argument2*

ERRIFDIFI

Force error for different arguments ignoring case

ERRIFDIFI *argument1, argument2*

ERRIFE

Force error if *expr* is false

ERRIFE *expr*

Table 17.8a. continued

*Directive**Name**Syntax***ERRIFIDN**

Force error for identical arguments

ERRIFIDN *argument1, argument2***ERRIFIDNI**

Force error for identical arguments ignoring case

ERRIFIDNI *argument1, argument2***ERRIFNB**

Force error if argument is not blank

ERRIFNB *argument***ERRIFNDEF**

Force error if symbol is not defined

ERRIFNDEF *name***EVEN**

Align code to even address

EVEN

EVENDATA

Align data to even address

EVENDATA

EXITM

Exit macro

EXITM

EXTRN

Define external symbol

EXTRN *definition [,definition]...**definition ::= name:type[:count]***FARDATA**

Start of far data segment

FARDATA [*name*]**GLOBAL**

Define global symbol

GLOBAL *definition [,definition]**definition ::= name:type[:count]***GROUP**

Define segment group

GROUP *name segmentname [,segmentname]...*

Directive
Name
Syntax

IDEAL

Switch to Ideal mode

IDEAL

IF

Assemble if condition is true

IF *condition*

IF1

Assemble if on pass 1

IF1

IF2

Assemble if on pass 2

IF2

IFB

Assemble if argument is blank

IFB *argument*

IFDEF

Assemble if symbol is defined

IFDEF *name*

IFDIF

Assemble if arguments differ

IFDIF *argument1, argument2*

IFDIFI

Assemble if arguments differ ignoring case

IFDIFI *argument1, argument2*

IFE

Assemble if expr equals 0 (is false)

IFE *expr*

IFIDN

Assemble if arguments are identical

IFIDN *argument1, argument2*

IFIDNI

Assemble if arguments are identical ignoring case

IFIDNI *argument1, argument2*

IFNB

Assemble if argument is not blank

IFNB *argument*

Table 17.8a. continued

<i>Directive</i>	<i>Name</i>	<i>Syntax</i>
IFNDEF	Assemble if name is not defined	IFNDEF <i>name</i>
%INCL	List include files	%INCL
INCLUDE	Include separate file	INCLUDE " <i>filename</i> "
INCLUDELIB	Include library file during linking	INCLUDELIB " <i>filename</i> "
IRP	Insert repeated parameter	IRP <i>parameter</i> , < <i>text</i> [, <i>text</i>]...> <i>statements</i>
		ENDM
IRPC	Insert repeated parameter for characters	IRPC <i>parameter</i> , <i>text</i> <i>statements</i>
		ENDM
JUMPS	Enable conditional jump adjustments	JUMPS
LABEL	Define typed symbol	LABEL <i>name type</i>
%LINUM	Set listing line number field width	%LINUM <i>size</i>
%LIST	Listing on	%LIST

Directive

Name

Syntax

LOCAL

Define local symbol in macros

LOCAL *name*[,*name*]...

LOCAL

Define local symbol in procedures

LOCAL *definition* [*definition*]... [=*name*]

definition ::= *name*:*type*[:*count*]

LOCALS

Enable local labels

LOCALS [*prefix*]

MACRO

Start macro definition

MACRO *name* [*parameter* [,*parameter*]...]

%MACS

List macro expansions

%MACS

MASM

Enable MASM-compatible assembly

MASM

MASM51*

Enable MASM version 5.1 enhancements

MASM51

MODEL

Select memory model

MODEL *memorymodel* [,*language*]

MULTERRS

Enable multiple errors per line

MULTERRS

NAME

Change module name

NAME *filename*

*Replaced with VERSION in version 3.0. See Table 17.8d.

continues

Table 17.8a. continued

*Directive**Name**Syntax***%NEWPAGE**

Start new listing page

%NEWPAGE**%NOCONDS**

List no false conditional statements

%NOCONDS**%NOCREF**

List no cross reference

%NOCREF [*name* [,*name*]...]**%NOCTLS**

List no listing controls

%NOCTLS**NOEMUL**

Disable coprocessor emulation

NOEMUL**%NOINCL**

List no include files

%NOINCL**NOJUMPS**

Disable conditional jump adjustments

NOJUMPS**%NOLIST**

Disable listing

%NOLIST**NOLOCALS**

Disable local labels

NOLOCALS**%NOMACS**

List only code-generating macro statements

%NOMACS**NOMASM51***

Disable MASM version 5.1 enhancements

NOMASM51

*Replaced with VERSION in version 3.0. See Table 17.8d.

Directive

Name

Syntax

NOMULTERRS

Disable multiple errors per line

NOMULTERRS

%NOSYMS

List no symbol table

%NOSYMS

%NOTRUNC

Word-wrap long fields in listing

%NOTRUNC

NOWARN

Disable warning message

NOWARN [*warnclass*]

ORG

Set location counter origin

ORG *expr*

P186

Enable 80186 instructions

P186

P286

Enable all 80286 instructions

P286

P286N

Enable 80286 non-protected-mode instructions

P286N

P287

Enable 80287 coprocessor instructions

P287

P386

Enable all 80386 instructions

P386

P386N

Enable 80386 non-protected-mode instructions

P386N

continues

Table 17.8a. continued

<i>Directive</i>	<i>Name</i>	<i>Syntax</i>
P387	Enable 8087 coprocessor instructions	P387
P8086	Enable only 8086/88 instructions	P8086
P8087	Enable 8087 coprocessor instructions	P8087
%PAGESIZE	Set listing page height and width	%PAGESIZE <i>[rows] [,columns]</i>
%PCNT	Set listing segment:offset field width	%PCNT <i>width</i>
PNO87	Disable coprocessor instructions	PNO87
%POPLCTL	Pop listing controls from assembler stack	%POPLCTL
PROC	Define new procedure	PROC <i>name [distance] [USES reglist] [arglist] [=name]</i> <i>[RETURNS arglist]</i> <i>reglist ::= register [register]...</i> <i>arglist ::= definition [,definition]...</i> <i>definition ::= name:typedef</i> <i>typedef ::= type PTR [type] \ [distance [PTR [type]]]</i>
PUBLIC	Define public symbol	PUBLIC <i>name [,name]...</i>

*Directive**Name**Syntax***PURGE**

Delete macro definition

PURGE *macroname* [,*macroname*]...**%PUSHLCTL**

Push listing controls onto assembler stack

%PUSHLCTL

QUIRKS*

Enable MASM quirks

QUIRKS

RADIX

Set default radix

RADIX *expr***RECORD**

Define bit-field record

RECORD *name definition* [,*definition*]...*definition ::= fieldname:width[=expr]***REPT**

Repeat statements

REPT *expr**statements*

ENDM

SEGMENT

Define segment

SEGMENT *name* [*align*] [*combine*] [*use*] [*'class'*]**STACK**

Start new stack segment

STACK [*size*]**STRUC**

Define structure

STRUCT *name**fields*ENDS [*name*]**%SUBTTL**

Declare listing subtitle

%SUBTTL "*text*"

*Replaced with VERSION in version 3.0. See Table 17.8d.

Table 17.8a. continued

<i>Directive</i>	<i>Name</i>	<i>Syntax</i>
%SYMS	Enable listing symbol table	%SYMS
%TABSIZ	Set listing column tab width	%TABSIZ <i>width</i>
%TEXT	Set listing source field width	%TEXT <i>width</i>
%TITLE	Set listing title	%TITLE "text"
%TRUNC	Truncate long fields in listings	%TRUNC
UDATASEG	Start new uninitialized data segment	UDATASEG
UFARDATA	Start new uninitialized far data segment	UFARDATA
UNION	Define union	UNION <i>name</i> <i>fields</i> ENDS [<i>name</i>]
USES	Auto push and pop registers (language models only)	USES <i>register</i> [, <i>register</i>]...
WARN	Enable a warning message	WARN [<i>warnclass</i>]

Table 17.8b. Turbo Assembler 2.0 Directives.

<i>Directive</i>
<i>Name</i>
<i>Syntax</i>
P486
Enable 80486 instructions
P486
P486N
Enable 80486 non-protected-mode instructions
P486N
P487
Enable 80487 coprocessor instructions
P487
P586
Enable 80586 (Pentium) instructions
P586
P586N
Enable 80586 non-protected-mode instructions
P586N
P587
Enable 80587 coprocessor instructions
P587
PUBLICDLL
Define dynamic link library entry points
PUBLICDLL [language] symbol [, [language] symbol]...
RETCODE
Generate model-dependent ret
RETCODE
STARTUPCODE
Insert model-dependent initialization code
STARTUPCODE

Table 17.8c. Turbo Assembler 2.5 Directives.

<i>Directive</i>
<i>Name</i>
<i>Syntax</i>
ENTERD
Same as enter but use ebp and esp
ENTERD
ENTERW
Same as enter but use bp and sp
ENTERW
LEAVED
Same as leave but use ebp and esp
LEAVED
LEAVEW
Same as leave but use bp and sp
LEAVEW

Table 17.8d. Turbo Assembler 3.0 Directives.

<i>Directive</i>
<i>Name</i>
<i>Syntax</i>
CATSTR
Concatenate string text macros
<i>name</i> CATSTR <i>string</i> [, <i>string</i>]...
ENUM
Create enumerated data type
<i>name</i> ENUM [<i>name</i> [, <i>name</i>]]
[{ <i>name</i> [, <i>name</i>]...}]
EXITCODE
Insert model-dependent termination code
EXITCODE <i>expr</i>
FASTIMUL
Generate efficient imul or shift/add instructions
FASTIMUL <i>register</i> , <i>register</i> <i>memref</i> , <i>value</i>
FLIPFLAG
Generate efficient XOR instruction
FLIPFLAG <i>register</i> , <i>memref</i>

Directive

Name

Syntax

GETFIELD

Get a value from a record field

GETFIELD *name register, memref | register*

GOTO

Start macro expansion at label

GOTO *label*

INSTR

Find substring in string macro

name INSTR [*start_expr*,] *string1, string2*

LARGESTACK

Override MODEL stack size to 32-bit

LARGESTACK

MASKFLAG

Generate efficient bitwise AND instruction

MASKFLAG *register, memref*

SETFIELD

Set a value in a record field

SETFIELD *name memref | register, register*

SETFLAG

Generate efficient bitwise OR instruction

SETFLAG *register, memref*

SIZESTR

Return length of string macro

name SIZESTR *string*

SMALLSTACK

Override MODEL stack size to 16-bit

SMALLSTACK

SUBSTR

Define text macro as substring

name SUBSTR *string, position_expr [,size_expr]*

TABLE

Declare table of object methods

Created by TASM: See Chapter 14

continues

Table 17.8d. continued

<i>Directive</i>
<i>Name</i>
<i>Syntax</i>
TBLINIT Initialize VMT pointer TBLINIT ds:bx
TBLINST Creates VMT instance for an object TBLINST
TBLPTR Locate an object's virtual table TBLPTR
TESTFLAG Generate efficient TEST instruction TESTFLAG register, memref
TYPEDEF Create a data type name TYPEDEF name type
VERSION Select assembler compatibility mode VERSION version_id
WHILE Repeat macro body WHILE expr macro_body ENDM

Table 17.8e. Turbo Assembler 3.1 Directives.

<i>Directive</i>
<i>Name</i>
<i>Syntax</i>
POPSTATE Pop Turbo Assembler state from internal stack POPSTATE

Directive
Name
Syntax

PUSHSTATE

Push Turbo Assembler state onto internal 16-level stack

PUSHSTATE

Table 17.8f. Turbo Assembler 3.2 Directives.

Directive
Name
Syntax

IRETW

Pop flags as WORD in 32-bit isr return

IRETW

POPAW

Pop all word registers in 32-bit code

POPAW

POPFW

Pop flags as WORD in 32-bit code

POPFW

PROCDESC

Declare procedure prototype

PROCDESC name [*description*]

(see PROC)

PROCTYPE

Create procedure (user-defined) data type

PROCTYPE name [*description*]

(see PROC)

PUSHAW

Push all word registers in 32-bit code

PUSHAW

PUSHFW

Push flags as WORD in 32-bit code

PUSHFW

A

APPENDIX

Assembling the Disk Files

- Assembly Language Listings, 818
- Pascal Listings, 819
- C Listings, 820
- C++ Listings, 820
- Object-Oriented Listings, 821
- Windows Listings, 822
- All Listings, 823
- Errors During Assembly, 824



If you haven't done so already, follow the instructions inside the back cover to install the files on the supplied disk. Also see the README.TXT file on disk for additional notes. This appendix suggests methods for assembling and compiling the installed files.

NOTE

The following instructions require Borland's MAKE.EXE version 3.7 utility to be on the system PATH. Other MAKE versions may also work. To test your configuration, enter `make /?` at a DOS prompt. If you do not receive a list of MAKE options, modify or insert a PATH statement in your root directory's AUTOEXEC.BAT file to include the directory where MAKE.EXE is stored. For example, you might use the following PATH statement:

```
PATH C:\windows;C:\dos;C:\tasm\bin
```

Assembly Language Listings

Use the MAKEASM.MAK file to assemble all assembly-language listings except for the object-oriented programs in Chapter 14 and the Windows applications in Chapter 15. This MAKE file also rebuilds the MTA.LIB library file, in which copies of various support modules such as STRINGS.OBJ and STRIO.OBJ are stored for easier linking.

Requirements

- Turbo Assembler 4.0.
- The system PATH must include the directory where TASM.EXE, TLINK.EXE, and TLIB.EXE are stored, usually C:\tasm\bin.
- The MTA.LIB file must be in the current directory. This file will be created and updated automatically if necessary.

Instructions

1. Change to the MTA directory. For example, enter the commands:

```
c:  
cd \mta
```

2. Run the MAKE utility, which issues commands as directed by instructions in the file, MAKEFILE. (A copy of this file is also provided in MAKEASM.MAK.) Enter the command:

```
make
```

3. In some cases, the text will suggest modifications to various programs. After you make these changes, save the modified file to disk and retype `make`. This will assemble and link *only* the modified program.



4. To delete extra files created during assembly, enter:

```
make clean
```

NOTE

Assembling the programs creates several new .OBJ, .EXE, and .COM files in the MTA directory. Read the text for instructions on running the .EXE and .COM programs. Some programs intentionally produce errors, or cause other critical events such as rebooting your computer to occur. A few programs should not be executed when Windows is running. In addition, many programs produce no on-screen output, and are intended to be traced with Turbo Debugger. *Always read about the program before running it.*

Pascal Listings

Follow the instructions in this section to compile the Borland Pascal listings in Chapter 12, "Mixing Assembly Language with Pascal."

Requirements

- Turbo Assembler 4.0.
- Borland Pascal 7.0. Earlier versions of Turbo Pascal might also work but are untested.
- The system PATH must include the directory where TASM.EXE and TLINK.EXE are stored, usually C:\tasm\bin. On some Borland Pascal installations, however, Turbo Assembler might be installed in C:\bp7\bin along with the Borland Pascal compiler.

Instructions

1. Change to the MTA directory. For example, enter the commands:

```
c:  
cd \mta
```

2. Run the MAKE utility, which issues commands as directed by instructions in the file, MAKEPAS.MAK. Enter the command:

```
make -fMAKEPAS.MAK
```

NOTE

You must use the DOS, command-line Turbo or Borland Pascal compiler. You may not use Turbo Pascal for Windows to compile the sample programs.



C Listings

Follow the instructions in this section to compile the C listings in Chapter 13, “Mixing Assembly Language with C and C++.”

Requirements

- Turbo Assembler 4.0.
- Borland C++ 4.0 or 4.5. Earlier versions of Turbo C++ may also work but are untested.
- The system PATH must include the directory where TASM.EXE and TLINK.EXE are stored, usually C:\tasm\bin. On some Borland C++ installations, however, Turbo Assembler might be installed in C:\bc4\bin along with the Borland C++ compiler. Use C:\bc45\bin for version 4.5.

Instructions

1. Change to the MTA directory. For example, enter the commands:

```
c:  
cd \mta
```

2. Run the MAKE utility, which issues commands as directed by instructions in the file, MAKEC.MAK. Enter the command:

```
make -fMAKEC.MAK
```

NOTE

You must use the DOS, command-line Borland C++ or Turbo C++ compilers. You may not use Turbo C++ for Windows to compile the sample programs.

C++ Listings

Follow the instructions in this section to compile the C++ listings in Chapter 13.

Requirements

- Turbo Assembler 4.0.
- Borland C++ 4.0 or 4.5.
- The system PATH must include the directory where TASM.EXE and TLINK.EXE are stored, usually C:\tasm\bin. On some Borland C++ installations, however, Turbo Assembler might be installed in C:\bc4\bin along with the Borland C++ compiler. Use C:\bc45\bin for version 4.5.



Instructions

1. Change to the MTA directory. For example, enter the commands:

```
c:  
cd \mta
```

2. Run the MAKE utility, which issues commands as directed by instructions in the file, MAKECPP.MAK. Enter the command:

```
make -fMAKECPP.MAK
```

NOTE

You must use the DOS, command-line Borland C++ compiler. You may not use Turbo C++ for Windows to compile the sample programs.

Object-Oriented Listings

Follow the instructions in this section to assemble the listings in Chapter 14, "Programming with Objects."

Requirements

- Turbo Assembler 4.0.
- The system PATH must include the directory where TASM.EXE and TLINK.EXE are stored, usually C:\tasm\bin.
- MTA.LIB must be in the \MTA directory (LIST program only).

Instructions

1. Change to the program's directory. For example, enter the commands:

```
c:  
cd \mta\oop\virtual
```

2. Run the MAKE utility, which issues commands as directed by instructions in the file, MAKEFILE. Enter the command:

```
make
```

3. Perform the preceding two commands for each of the following directories:

```
\mta\oop\encapsul  
\mta\oop\inherit  
\mta\oop\list  
\mta\oop\virtual
```

**NOTE**

Except for LIST demonstration, the object-oriented programs produce no on-screen output and are intended to be traced with Turbo Debugger. See the text in Chapter 14 for more information.

Windows Listings

Follow the instructions in this section to assemble the listings in Chapter 15, “Programming for Windows.”

Requirements

- Turbo Assembler 4.0.
- Borland C++ 4.0 or 4.5, another C or C++ Windows development system, or the Microsoft Windows SDK.
- The system PATH must include the directory where TASM.EXE and TLINK.EXE are stored, usually C:\tasm\bin.
- The system PATH must also include the directory where various Windows utilities such as the Borland resource compiler BRC.EXE are stored.
- The file WINDOWS.INC must be in C:\tasm\include.
- The file WINDOWS.H must be in C:\bc4\include. Use C:\bc45\include for version 4.5.

Instructions

1. Change to the program's directory. For example, enter the commands:

```
c:  
cd \mta\win\hello
```
- 2a. Run the MAKE utility, which issues commands as directed by instructions in the file, MAKEFILE. You must assemble the programs from a DOS prompt. Enter the command:

```
make
```
- 2b. Alternatively, run one of the supplied batch files, BUILD.BAT or MAK.BAT, to assemble with debugging information, and to create a listing output file. For example, to rebuild the program from scratch, enter the command:

```
build
```



3. Use the Windows File Manager to select and run the resulting .EXE code file. Or, you may use the Program or File Manager's *File|Run* commands and enter the program's pathname (`c:\mta\win\whello\whello.exe` for example).
4. Perform the preceding commands for each of the following directories:

```
\mta\win\whello
\mta\win\winapp
```

NOTE

If you receive errors during assembly and linking, you might have to edit the pathnames in the MAKEFILES in directories WHELLO and WINAPP.

All Listings

To assemble all listings (except the object-oriented examples in Chapter 14 and the Windows programs in Chapter 15), you may use the supplied MAKEALL.BAT batch file. Follow these instructions.

Requirements

- Turbo Assembler 4.0.
- Borland C++ 4.0.
- Borland Pascal 7.0.
- MAKE.EXE.
- The assembler, compiler, and MAKE executable files, and also the Borland linker, must be on the current PATH.

Instructions

1. Change to the MTA directory. For example, enter the commands:

```
c:
cd \mta
```

2. Run the MAKEALL.BAT batch file by entering the command:

```
makeall
```

Errors During Assembly

If you receive error messages, follow these suggestions:

- *Check your system's installation.* In addition to this book's listings, you must purchase and install Turbo Assembler 4.0. Some listings require Borland C++ 4.0 or 4.5 and Borland Pascal 7.0. The Windows examples also require utilities and files not supplied by Turbo Assembler.
- *Check your system's configuration.* TASM.EXE, TLINK.EXE, and TLIB.EXE must be on the system PATH. *At least 90% of errors reported by readers are due to an improperly configured system.* Be sure to type your PATH statement in AUTOEXEC.BAT exactly as shown in this appendix, with no extra spaces or punctuation. For most readers, the PATH statement should look something like this, although the directory names depend on your installation:

```
PATH
```

```
C:\windows;C:\dos;C:\tasm\bin
```

- *Add all installation directories to PATH.* If you have Borland C++ or Borland Pascal, also add these installation directories to the PATH. In that event, use a statement such as the following (change bc4 to bc45 if you have version 4.5):

```
PATH
```

```
C:\windows;C:\dos;C:\tasm\bi;C:\bc4\bin;C:\bp7\bin
```

- *Never attempt to configure your system for more than one assembler or compiler at a time.* Do not, for example, specify MASM and TASM directories in the PATH. This rule is especially important for C and C++ compilers, which refer to files that are named similarly, but that contain different contents. For example, if you have Borland C++ and Microsoft C/C++, create separate AUTOEXEC.BAT files to configure your system for working with only one of those compilers at a time.
- *Read the text.* Some error messages, warnings, and strange happenings are expected. Before you report that a program causes your system to reboot, check whether the program is *supposed* to do that. Always read about the program before running it.
- *Upgrade Turbo Assembler to version 4.0 or later.* If you have an earlier assembler version, see the instructions in the README.TXT file on disk for extracting the first-edition files. You might be able to use these files temporarily until you upgrade your assembler.
- *MAKE doesn't do anything.* This is normal. MAKE compares file dates and times to determine if a program is already assembled, compiled, or linked. To force MAKE to issue its commands anyway, add the -B (build) option. For example, enter `make -B`.

B

APPENDIX

File Directory

After installing the disk supplied with this book, compare the installation directory (usually C:\MTA) with the following tree diagram. This will verify that your installation is complete. To produce this listing, I installed the files and entered the following DOS command:

```
tree c:\mta /f /a >tree.txt
```

Listing B.1. File inventory.

Directory PATH listing for Volume CDRIVE
Volume Serial Number is 0000-0000

```
C:\MTA
|
| ADDHEX.ASM
| ADDSUB.ASM
| ANDORXOR.ASM
| ASMARG.ASM
| ASMARG2.ASM
| ASMFILL.ASM
| ASYNCH.ASM
| BCD.ASM
| BINASC.ASM
| BOUND286.ASM
| BOXCHAR.ASM
| CAPSLOCK.ASM
| CFILL.ASM
| CFILLSTR.C
| CFLAGS.C
| CHARS.ASM
| COLDBOOT.ASM
| COMSHELL.ASM
| CONVERT.ASM
| COPYSTR.ASM
| CPPARG.ASM
| CPPARG.CPP
| CPPFUNC.CPP
| CPPLOOP.ASM
| CPPPOOP.ASM
| CPPPOOP.CPP
| CSHELL.ASM
| DATETIME.ASM
| DISKERR.ASM
| DIV286.ASM
| DIV86.ASM
| DIVFAULT.ASM
| DOSMACS.ASM
| DR.ASM
| DT.ASM
| ECHOSTR.ASM
| EQUIP.ASM
| EXESHELL.ASM
| FF.ASM
| FILLSTR.ASM
| FILLSTR.PAS
| FILTER.ASM
```

HARDSHEL.ASM
KEYBOARD.ASM
KEYS.ASM
KOPY.ASM
LC.ASM
LF.ASM
MAKEALL.BAT
MAKEASM.MAK
MAKEC.MAK
MAKECPP.MAK
MAKEFILE
MAKEPAS.MAK
MOV.ASM
MTA.LIB
MULDIV.ASM
PARAMS.ASM
PASDEMO.ASM
PASDEMO.PAS
PASSHELL.ASM
PR132.ASM
PUSHPOP.ASM
README.TXT
REBOOT.ASM
SCREEN.ASM
SHIFT.ASM
SHOWPAM.ASM
SINGLE.ASM
SLOWMO.ASM
STR.ASM
STR.PAS
STRINGS.ASM
STRIO.ASM
STRSLOW.PAS
STRUC.ASM
SUBDEMO.ASM
TABLE.ASM
TALLY.ASM
TALLY.C
TRM.ASM
UPCASE.ASM
UPDOWN.C
VERSION.ASM

+--WIN

+ --WINAPP

BUILD.BAT
MAK.BAT
MAKEFILE
WINAPP.ASM
WINAPP.DEF
WINAPP.EXE
WINAPP.ICO
WINAPP.OBJ
WINAPP.RC
WINAPP.RES

B

Listing B.1. continued

```
WINAPP.RH
WINAPP.RI
\--WHELLO
    BUILD.BAT
    MAK.BAT
    MAKEFILE
    WHELLO.ASM
    WHELLO.DEF
    WHELLO.EXE
    WHELLO.ICO
    WHELLO.OBJ
    WHELLO.RC
    WHELLO.RES
+--001
    MTA001.EXE
\--OOP
    OOMACROS.INC
    TDATEOBJ.INC
    TRECT.INC
+--ENCAPSUL
    ENCAPSUL.ASM
    MAKEFILE
    TPOINT.INC
+--VIRTUAL
    MAKEFILE
    TBASE.INC
    TDERIVED.INC
    VIRTUAL.ASM
+--INHERIT
    INHERIT.ASM
    MAKEFILE
    TBASE.INC
    TDERIVED.INC
\--LIST
    LIST.ASM
    MAKEFILE
    TINTOBJ.INC
    TITEM.INC
    TLIST.INC
    TSTROBJ.INC
```

C

APPENDIX

Answers to Exercises

Chapter 1

- 1.1 Machine language, an improper synonym for assembly language, refers to the binary code that drives a computer processor; therefore, machine code is a better term.
- 1.2 Most computer languages are high level. C, Pascal, BASIC, and others, while varying in many ways, are all considered to be high-level languages. Machine code is the lowest of low-level languages. Assembly language is somewhere in between, giving programmers a way to program the CPU directly while taking advantage of features normally found in high-level languages.
- 1.3 Individual assembly language instructions translate (assemble) directly to single machine codes. Individual high-level language statements usually translate (compile) to many machine codes.
- 1.4 Machine code is cumbersome because many codes depend on their position in a program or refer to fixed addresses in memory. Modifying machine code directly is impractical. Early programmers had no choice in the matter because there weren't any computer languages—not even assembly language—in the dawn of the computer age.
- 1.5 Debuggers such as Turbo Debugger help programmers fix broken programs by running code at slow speed, stopping at various locations, so you can examine processor registers and memory values. These same features provide ways to examine the inner workings of programs, too, and can help prevent system crashes.
- 1.6 A register is a small amount of memory located inside the CPU and directly affected by certain machine-code instructions.
- 1.7 A flag is a single bit of memory located inside the CPU and, like registers, directly affected by certain machine-code instructions.
- 1.8 Ideal mode assembles faster than MASM mode. Ideal mode syntax is easier to understand and use than MASM mode. Ideal mode adds features that are especially useful for writing stand-alone assembly language programs.
- 1.9 Advantages of assembly language include the promise (but not the guarantee) of top speed and the ability to directly control the CPU and peripheral devices attached to the computer.
- 1.10 Many disadvantages are often cited about assembly language. The major disadvantage is the difficulty of transferring assembly language programs from one processor to another. Doing so usually means writing the program over from scratch.



Chapter 2

- 2.1 Header: 1–6, Equates: 7–11; Data: 12–24; Body: 25–40; Closing: 41.
- 2.2 prCodes
- 2.3 There are 14 comments in Listing 2.1. Did you miss the comment in line 8?
- 2.4 Turbo Assembler allows either a dash (–) or a forward slash (/). Early versions of Turbo Linker allow only a forward slash. Turbo Linker 6.00 allows a dash or a slash.
- 2.5 `tasm -zi bugaboo`
`tlink /v bugaboo`
- 2.6 Turbo Assembler creates object code. Turbo Linker further processes object-code files to create executable programs. The purpose of object code is to allow programmers to write and assemble large programs in separate pieces, or modules. Turbo Linker can join multiple modules to create the finished code file.
- 2.7 An error is fatal—the resulting object code will not link or run. A warning is not fatal—the resulting object code might link and run. If you receive an error, you should examine and fix the line identified by the number in parentheses. If you receive a warning, you should probably do the same, unless you are certain, based on your intimate knowledge of the program, that the warning may be safely ignored.
- 2.8 A .COM code file organizes its data, code, and stack in one memory segment. An .EXE code file separates the programs data, code, and stack into separate memory segments. Writing .EXE programs takes a little more work than writing .COM programs. Programs in .COM format always occupy 64K of memory. Programs in .EXE format occupy only as much memory as they need.
- 2.9 `tasm -l listme`
`type listme.lst>prn`
OR
`tasm -l-c listme`
`type listme.lst>prn`
- 2.10 Assembly language programs do not end—they hand over control to another program, usually COMMAND.COM.
- 2.11 DB reserves space for one or more byte variables in memory. You can use DB to reserve space for single and multiple bytes, plus one or more character strings.



Chapter 3

3.1 Binary digit.

3.2 There are 8 bits in a byte and 2 bytes in a word. There are 4 words in a quadword.

3.3 MSD—most significant digit; LSD—least significant digit; MSB—most significant byte; LSB—least significant byte.

```

3.4  0110 1011 1111 1001
      + 1010 1011 1100 1000
      -----
      1 0001 0111 1100 0001

```

```

3.5  6BF9
      +ABC8
      -----
      117C1

```

3.6 $(2 \times 2 \times 2 \times 2 \times 2 \times 2) = 128$. The value 2^7 is the power of column number 7, the seventh column from the right. Did you remember that the rightmost column (LSB) is number 0?

```

3.7  3ECA = (3x4096) + (14x256) + (12x16) + (10x1) = 16,704
      2F78 = (2x4096) + (15x256) + (7x16) + (8x1) = 12,152
      2F78 = 0010 1111 0111 1000

```

```

3.8  AND mask = 0010 1100
      OR mask  = 1100 0000
      XOR mask = 1000 0000

```

Did you remember that bits are numbered from right to left, starting with 0? If not, see Figure 3.1 and try again.

```

3.9  a??? ab?? (a=bits 3,7; b=bit 2; ?=to preserve)
      AND 0111 0111 (AND mask)
          0??? 0b?? (sresult of AND)
      OR  1000 1000 (OR mask)
          1??? 1b?? (result of OR)
      XOR 0000 0100 (XOR mask)
          1??? 1B?? (result of XOR; B = NOT b)

```

3.10 $(6 \times 2048 \times 8) = 98,304$

3.11 Original Value	One's Complement	Two's Complement
1011 1111	0100 0000	0100 0001
0000 0001	1111 1110	1111 1111
1000 0000	0111 1111	1000 0000
1110 0001	0001 1110	0001 1111
1111 1111	0000 0000	0000 0001

3.12 1111 1001 (original signed value)

0000 0110 (one's complement)

0000 0111 (two's complement)

Forming the two's complement of 1111 1011 equals 7, indicating that the original binary value is -7 in two's complement notation.

3.13 Six bits can express values up to $(2*2*2*2*2*2) - 1$, or 63. Nine bits can express up to $(2*2*2*2*2*2*2*2*2)$, or 512, including 0.

3.14 0011 1001 $\times 4 = 1110 0100$ (shift left 2 times)

57 $\times 4 = 228$ (in decimal)

1001 1100 / 8 = 0001 0011 (shift right 3 times)

156 / 8 = 19 (in decimal)

You can't multiply 0101 0101 by 8 accurately using left shifts because the result is larger than 8 bits.

Chapter 4

4.1 The minimum size of a segment is 16 bytes because a segment must begin on a 16-byte boundary in memory—therefore, segments must either overlap or be separated by at least 16 bytes. The maximum size of a segment is 65,536 bytes (roughly 64K).

4.2 xor ax, ax

sub ax, ax

mov ax, 0

and ax, 0

mov cl, 16

shl ax, cl ; or shr

4.3 push dx ; Push dx onto stack

pop ax ; Pop value of dx into ax

4.4 neg forms the two's complement of a byte or word; not forms the ones complement of a byte or word.

4.5 mov cl, 17

rcl ax, cl ; or rcr

The rcl and rcr instructions treat cf as though it were the 17th bit of a word (or the 9th bit of a byte). Therefore, these are the only two instructions that can rotate a value back to its original state and preserve cf.

4.6 mov dh, ah ; Copy original value to dh from ah

mov cl, 4 ; Prepare to execute 4 shifts

shr dh, cl ; Shift upper 4 bits right

mov dl, ah ; Copy original value to dl from ah

and dl, 0Fh ; Strip all but lower 4 bits



- ```
4.7 mov cl, 3 ; Prepare to execute 3 shifts
 shl dh, cl ; Shift bit 5 into cf
 jc BitIsSet ; Jump only if cf = 1
```
- ```
4.8 jl Target     ; Jump if less to Target
    jnl Continue  ; Jump if not less to Continue
    jmp Target    ; Jump if less to Target
Continue:
```
- ```
4.9 xor bx, 0FFFFh ; Ones complement of bx
 inc bx ; plus 1 forms twos complement
```
- ```
4.10 mov ax, ax
      OR
      jmp short next:
next:
```
- 4.11 A string repeat prefix repeats one of the four string instructions `cmps`, `lods`, `scas`, and `stos` by the number of times specified in `cx`. When used with `cmps` and `scas`, the repetitions stop when `zf` indicates that the comparison or scan condition failed.
- ```
4.12 xor cx, cx
 rep scasb ; Or repe or repz
```

## Chapter 5

- ```
5.1 mov ax, 1      ; Immediate data
    xor cx, cx     ; Register data
    mov bx, [index] ; Memory data
```
- ```
5.2 inc [bankBalance] ; Direct addressing
 sub [word bx], 5 ; Register-indirect [bx] addressing
 mov ax, [bp + 10] ; Base addressing
 and [byte si + 6], 0Fh ; Indexed addressing
 mov [word bx + di + 2], 0 ; Base-indexed addressing
```
- ```
5.3 DATASEG
aByte db 0
aWord dw 0
aString db 'This is a string'
UDATASEG
aBuffer db 1024 DUP (?)
```
- ```
5.4 mov di, offset aBuffer ; Address aBuffer with di
 mov cx, 1024 ; Assign loop count to cx
 cld ; Auto-increment di
@@10:
 mov al, cl ; Assign value to al
 stosb ; Store al in aBuffer
```

```

 ; [di]
loop @@10 ; Loop until cx = 0
ret ; Return to caller

```

**5.5** tasm module  
 tasm program  
 tlink program module ; Or tlink program + module

**5.6** The linker can extract only the modules it needs. Using the extended dictionary option speeds linking.

**5.7** PUBLIC directives export procedure, numeric constant, and variable labels from one module to others. EXTRN imports these same kinds of symbols into a module.

**5.8** The jmp refers to the second @@40: local label (the one under the je instruction) because the global Repeat: label blocks the view of the first @@40: from jmp. Remember that local labels extend only up and down to the nearest global label.

**5.9** The MaxCount, YesAnswer, and BufferSize equates can be exported in a PUBLIC directive. If you didn't include YesAnswer in your answer, remember that characters in assembly language are just numbers expressed in ASCII in the program text.

**5.10** s1 db 20 DUP (?)  
 s2 db '12345678901234567890'  
 s3 db 'abcdefghij'  
 db 'klmnopqrst'

The last two lines create a single string variable with 20 characters because variables are stored sequentially in memory.

**5.11** tasm printer  
 tasm getdata  
 tasm readtext  
 tasm YourProgram  
 tlink YourProgram,,,mta

Or, for the link step:

```
tlink YourProgram printer getdata readtext strings strio
```

**5.12** tlib /E mta --+printer  
 tlib /E mta --+getdata  
 tlib /E mta --+readtext

**5.13** CODESEG  
 jmp short @@10 ; Jump over data  
 Flag db 0fh ; Store byte in code segment  
 @@10:  
 mov dh, [cs:Flag] ; Load byte into dh

Storing data in the code segment this way is not usually necessary (and is, perhaps, unwise). Still, the technique is available if you need it. To refer to the byte requires using the segment override instruction prefix cs:.





```
5.14 quotable db '"This 'string' can't have "too" many'
 db 'quotes," she said.'
```

There are several possible answers, but this answer works. For space reasons and for demonstration purposes, this answer is listed on two lines. You could declare the entire string on one line.

## Chapter 6

```
6.1 STRUC Time
 hours db 0 ; 0-23
 minutes db 0 ; 0-59
 seconds db 0 ; 0-59
ENDS
```

6.2 Assuming the default field values are 0:

```
DATASEG
TenThirtyFortyFive Time <10,30,45>
FourteenHundred Time <14> ; Or <14,,> or <14,0,0>
SixteenThirty Time <16,30> ; Or <16,30,>
 ; or <16,30,0>
Midnight Time <> ; Or <0,0,0>
```

```
6.3 DATASEG
theTime Time <>
oldTime Time <>
```

```
CODESEG
; set the time to 15:45:12
mov [theTime.hours], 15
mov [theTime.minutes], 45
mov [theTime.seconds], 12

; Increment the hour
inc [theTime.hours]

; Reset the time to 00:00:00 (assumes es = data segment)
xor ax,ax ; ax <- 0000
mov di, OFFSET theTime ; Address theTime with es:di
cld
stosw ; Zero hours and minutes fields
stosb ; Zero seconds

; Copy theTime to oldTime
mov al, [theTime.hours]
mov [oldTime.hours], al
mov al, [theTime.minutes]
mov [oldTime.minutes], al
```



```
mov al, [theTime.seconds]
mov [oldTime.seconds], al
```

6.4

|          |           |               |
|----------|-----------|---------------|
| 00001011 | (hex)     | = 4113        |
| 10000000 | (binary)  | = 128         |
| 1234     | (hex)     | = 4660        |
| 4321d    | (decimal) | = 4321        |
| FACE     | (label)   | = not a value |
| 00FF     | (hex)     | = 255         |

## 6.5 DATASEG

```
f1 dt 2.5
f2 dt 88.999
f3 dt 0.141
bcd1 dt 125000
bcd2 dt 1250500
```

The largest possible binary-coded-decimal number is 20 digits long, or 99,999,999,999,999,999,999.

## 6.6 DATASEG

```
WordArray dw 45 DUP (0) ; 90 bytes
DoubleArray dd 100 DUP (0) ; 400 bytes
Buffer 1024 db 1024 DUP (0) ; 1024 bytes
BCDArray dt 75 DUP (0) ; 750 bytes
```

## 6.7 DATASEG

```
index dw 0 ; Word array index
CODESEG
; WordArray
mov bx, [index] ; Get index value
shl bx, 1 ; Multiply by 2
add bx, OFFSET WordArray ; Add to array address

; DoubleArray
mov bx, [index] ; Get index value
shl bx, 1 ; Multiply by 4
shl bx, 1
add bx, OFFSET DoubleArray; Add to array address

; Buffer1024
mov bx, [index] ; Get index value
add bx, OFFSET Buffer1024 ; Add to array address

; BCDArray
mov bx, [index] ; Get index value
mov ax, bx ; Save in ax temporarily
mov cl, 3 ; Assign shift count
shl bx, cl ; Multiply index by 8
shl ax, 1 ; Multiply index by 2
add bx, ax ; Finish multiply by 10
add bx, OFFSET BCDArray ; Add to array address
```

**6.8** STRUC FourBytes

```

byte1 db ?
byte2 db ?
byte3 db ?
byte4 db ?
ENDS FourBytes

```

## STRUC TwoWords

```

loWord dw ?
hiWord dw ?
ENDS TwoWords

```

## UNION ByteWordDWord

```

asBytes FourBytes <>
asWords TwoWords <>
asDWord dd ?
ENDS ByteWordDWord

```

## DATASEG

```
v1 ByteWordDWord <>
```

## CODESEG

```

mov ah, [v1.asBytes.byte3]
mov ax, [v1.asWords.hiWord]
mov bx, offset v1.asDWord
mov ax, [bx]
mov dx, [bx + 2]

```

**6.9** RECORD inventory location:3, status:1, quantity:5, vendor:4

This record occupies one word because more than 8 bits are specified. The range of values for each field are:

```

location = 0 to 7
status = 0 to 1
quantity = 0 to 31
vendor = 0 to 15

```

**6.10** maskLocation = MASK location

```

maskStatus = MASK status
maskQuantity = MASK quantity
maskVendor = MASK vendor

```

## DATASEG

```
inv inventory <>
```

## CODESEG

```

; Set location to 3
and [inv], NOT maskLocation ; Punch hole in record
or [inv], 3 SHL location ; Insert 3 into hole

; Set status to 1
or [inv], maskStatus ; Set single bit = 1

```

```

; Add 6 to quantity field
mov ax, [inv] ; Load record into ax
and ax, maskQuantity ; Isolate quantity field
mov cl, quantity ; Assign shift count to cl
shr ax, cl ; Move value to right
add ax, 6 ; Add 6 to value
shl ax, cl ; Shift back into position
and ax, maskQuantity ; Limit value (optional)
and [inv], NOT maskQuantity ; Punch hold in value
or [inv], ax ; Insert new quantity

; Load vendor field into dh
mov dx, [inv] ; Load record into dx
and dx, maskVendor ; Isolate vendor field
mov cl, vendor ; Assign shift count to cl
shr dx, cl ; Move to right of dx
xchg dh, dl ; Swap result from dl into dh

; Toggle the status field
xor [inv], maskStatus ; 0 -> 1; or 1 -> 0

; Zero all fields in the record
xor ax, ax ; Set ax = 0000
mov [inv], ax ; Set inv = ax

```

- 6.11** There are several possible answers to this question, the following being one of the simplest. To save space here, ADDHEX.ASM does not flag errors, as it probably should. See the CONVERT program in Chapter 6 for hints on how you can improve ADDHEX. Assemble and link the program with the commands:

```

tasm addhex
tlink addhex,,, mta

```

#### Listing Answers.1. ADDHEX.ASM.

```

1: %TITLE "Sum of two hex values -- by Tom Swan"
2:
3: IDEAL
4:
5: MODEL small
6: STACK 256
7:
8: DATASEG
9:
10: exCode DB 0
11: prompt1 DB 'Enter value 1: ', 0
12: prompt2 DB 'Enter value 2: ', 0
13: string DB 20 DUP (?)
14:
15: CODESEG

```

**Listing Answers.1. continued**

---

```

16:
17: EXTRN StrLength:proc
18: EXTRN StrWrite:proc, StrRead:proc, NewLine:proc
19: EXTRN AscToBin:proc, BinToAscHex:proc
20:
21: Start:
22: mov ax, @data ; Initialize DS to address
23: mov ds, ax ; of data segment
24: mov es, ax ; Make es=ds
25:
26: mov di, offset prompt1 ; Address prompt #1
27: call GetValue ; Prompt for input
28: push ax ; Save first value
29: mov di, offset prompt2 ; Address prompt #2
30: call GetValue ; Prompt for input
31: pop bx ; Get first value
32: add ax, bx ; ax <- sum of values
33: mov cx, 4 ; Request 4 digits
34: mov di, offset string ; Address string
35: call BinToAscHex ; Convert ax to string
36: call StrWrite ; Display answer
37: Exit:
38: mov ah, 04Ch ; DOS function: Exit program
39: mov al, [exCode] ; Return exit code value
40: int 21h ; Call DOS. Terminate program
41:
42: ; GetValue: di=address of prompt; output: ax=value entered in hex
43: PROC GetValue
44: call StrWrite
45: mov di, offset string
46: mov cl, 4
47: call StrRead
48: call NewLine
49: call StrLength
50: mov bx, cx
51: mov [word bx + di], 'h'
52: call AscToBin
53: ret
54: ENDP GetValue
55:
56: END Start ; End of program / entry point

```

---

**6.12** See lines 16–17 and 31–32 in Listing 6.2 VERSION.ASM, if you are having trouble with this one.

## Chapter 7

```

7.1 mov ah, 1 ; Specify DOS Character Input function
 int 21h ; Call DOS. Character returned in al

 mov ah, 7 ; Specify DOS Unfiltered input without echo
 int 21h ; Call DOS. Character returned in al

 mov ah, 8 ; Specify DOS Filtered input without echo
 int 21h ; Call DOS. Character returned in al

7.2 @@10:
 mov ah, 7 ; Unfiltered input without echo
 int 21h
 cmp al, 27 ; ASCII ESC
 je Exit ; Exit on Esc key
 cmp al, 'a' ; Check for lowercase letter
 jb @@20
 cmp al, 'z'
 ja @@20
 sub al, 'z' - 'Z'; Convert to uppercase
@@20:
 mov dl, al ; Assign character to dl
 mov ah, 2 ; Character output function number
 int 21h ; Call DOS to write character
 jmp @@10

```

In the sub instruction, instead of 'z' - 'Z', you can also use 'a' - 'A' or just 32.

```

7.3 PROC EscKey
 push ax ; Save ax on stack
 mov ah, 11 ; Get input status
 int 21h ; Call DOS
 or al, al ; Does al = 0? (i.e., no key waiting)
 je @@10 ; Jump if so (zf = 1)
 mov ah, 7 ; Unfiltered input without echo
 int 21h ; Call DOS to get key press
 cmp al, 27 ; Does al = Esc?
 je @@20 ; Jump if al = Esc (zf = 1)
@@10:
 or al, 1 ; Set zf = 0
@@20:
 pop ax ; Restore saved ax
 ret ; Return to caller
ENDP EscKey

```

There are other good solutions. For example, the second je can be replaced with a jmp short @@20 as zf is already set or cleared correctly by the previous cmp. There's no need to reset zf to 0 if al does not equal 27. As this shows, juggling



flags can be tricky. Run tests in Turbo Debugger if you're having trouble understanding how the code works.

- 7.4 Replace the `cmp` and `je` instructions just above label `@@10:` in the answer to question #7.3 with:

```

or al, al ; Does lead-in = 0?
jne @@20 ; No, so exit (cant be F1)
int 21h ; Call DOS to get second key press
cmp al, 03Bh ; Does al = F1 code?
jmp short @@20 ; Exit with zf properly set

```

- 7.5 A handle is a 16-bit number that represents a logical file. DOS lets you specify handles to direct a program's I/O to and from various logical files. DOS preassigns five handles.

- 7.6 Filter programs read from the standard input file and write to the standard output file; therefore, their input and output can be piped together with other filters to create complex commands out of relatively simple programs. DOS supplies three standard filters: `SORT`, `FIND`, and `MORE`.

- 7.7 DATASEG

```

string db 'I hate meeses to pieces'
strlen = $ - string

```

- 7.8 ; al=char to display; changes bx, dx, di

```

PROC FillScreen
 push ax ; Save ax on stack for later use
 mov dh, 24 ; Initialize dh to maximum row
@@10:
 mov dl, 79 ; Initialize dl to maximum column
@@20:
 pop ax ; Get character to display
 push ax ; Save character on stack again
 push dx ; Save dx--changed by ScPokeChar
 call ScPokeChar; Display one character
 pop dx ; Restore dx
 dec dl ; Subtract 1 from column number
 jns @@20 ; Jump if dl >= 0
 dec dh ; Subtract 1 from row number
 jns @@10 ; Jump if dh >= 0
 pop ax ; Restore original ax value
 ret ; Return to caller
ENDP FillScreen

```

This subroutine demonstrates how to save values temporarily on the stack. Each time through the loop at label `@@20:`, the character is popped from the stack and then immediately pushed for the next pass. In this way, the stack serves as a temporary holding place for the variable—an especially useful technique when all

registers are used for other purposes. The initial push at the start and the pop at the end are both required to make this method work.

- 7.9** The following is not a complete program. To test the code, add the instructions at appropriate places to a copy of EXESHELL.ASM from Chapter 2.

```

Red EQU 4 ; Value for red attribute
White EQU 7 ; Value for white attribute

DATASEG
message db 'ERROR: Dumb mistake detected', 0

CODESEG
EXTRN ScReadXY:proc, ScPokeStr:proc, StrLength:proc
EXTRN ScSetBack:proc, ScSetFore:proc, ScBright:proc
EXTRN ScBlink:proc
mov al, Red ; Assign red color to al
call ScSetBack ; Set background to red
mov al, White ; Assign white color to al
call ScSetFore ; Set foreground to white
call ScBright ; Make it whiter than white
call ScBlink ; Blink foreground
mov di, offset message ; Address message with es:di
call StrLength ; Set cx = length of message
call ScReadXY ; Get current cursor location
mov si, offset message ; Address message with ds:si
call ScPokeStr ; Display message at cursor

```

- 7.10** ScInit.

```

7.11 PROC YesNo
push ax ; Save ax on stack
@@10:
call GetCh ; Get key press
je @@10 ; Reject function and control keys
cmp al, 'y'; Does key = lowercase y?
je @@99 ; Jump if yes
cmp al, 'Y'; Does key = uppercase Y?
@@99:
pop ax ; Restore saved ax from stack
ret ; Return to caller
ENDP YesNo

```

## Chapter 8

- 8.1** The advantages include:

- Macros can reduce repetition
- Macros can clarify assembly language
- Macros let you customize Turbo Assembler

The disadvantages are:

Macros can hide effects on register values

Macros can increase assembly time

### 8.2 MACRO Startup

```
mov ax, @data ;; Initialize segment registers
mov ds, ax ;; ds and es to address the
 ;; programs
mov es, ax ;; data segment
```

ENDM Startup

8.3 1) Any nonzero value represents true; 2) only zero represents false; and 3) 1 or -1 typically represent true.

8.4 Comments preceded with double semicolons are not written to a listing file created with the /1 option during assembly. Comments preceded by single semicolons are listed each time the macro is used in the program. A double semicolon can reduce listing file size and, therefore, decrease printing time.

8.5 Use the PURGE directive to throw away a macro definition.

8.6 You don't specify parameter types in macro definitions. Parameter types depend on how the parameters are used inside the macro.

```
8.7 MACRO stz ;; Set zf flag = 1
 push ax ;; Save ax on stack
 lahf ;; Load flags into ah
 or ah, 040h ;; Set bit 6 (zf)
 sahf ;; Store ah to flags
 pop ax ;; Restore ax
 ENDM stz
```

```
MACRO clz ;; Clear zf flag = 0
 push ax ;; Save ax on stack
 lahf ;; Load flags into ah
 and ah, 0bfh ;; Clear bit 6
 sahf ;; Store ah to flags
 pop ax ;; Restore ax
 ENDM clz
```

### 8.8 ;----- Macro definition

```
MACRO AssignSeg reg, value
 push ax
 mov ax, value
 mov reg, ax
 pop ax
 ENDM AssignSeg
```

```
;----- Assign color video buffer address to es
AssignSeg es, 0B800h
```



```
8.9 INCLUDE "FLOAT.MAX"
INCLUDE "BIOSMAC.TXT"
INCLUDE "CUSTOM.MAX"
```

Did you remember the quotes required around file names in Turbo Assemblers Ideal mode?

```
8.10 True = -1
False = 0
;HasFasCrt = True ; For Pcs
HasFastCrt = False ; For plain MS-DOS systems
```

```
PROC WriteAChar
IF HasFastCrt
 call ScPokeChar ; Fast write to x,y
ELSE
 cmp al, '' ; Reject control codes
 jae @@HFC10 ; Jump if not a control
 mov al, '.' ; Char to display for controls
@@HFC10:
 cmp dh, 24 ; Does row = maximum?
 jne @@HFC20 ; Jump if not
 cmp dl, 79 ; Does column = maximum?
 je @@HFC99 ; Exit to prevent scroll!
@@HFC20:
 xchg dx, bx ; Preserve requested x,y
 call ScReadXY ; Get current cursor position
 push dx ; Save current position
 xchg bx, dx ; Restore requested x,y
 call ScGotoXY ; Position the cursor
 mov dl, al ; Assign character to dl
 MS_DOS 2 ; Call DOS output char function
 pop dx ; Restore saved cursor position
 call ScGotoXY ; Put cursor back where it was
ENDIF
@@HFC99:
 ret ; Return to caller
ENDP WriteAChar
```

The answer to this problem is trickier than it seems at first. Because `ScPokeChar` ignores the cursor position, poking characters directly into the video memory buffer, the DOS replacement code must read and restore the cursor to its original position. Also, because writing a character to the bottom right corner causes the display to scroll up one line, the code must prevent characters from being displayed at this position. Because control codes such as carriage returns and line feeds cause actions when written via DOS but not `ScPokeChar`, control codes



must be converted to another character (in this case, a period). Obviously, then, the two routines can't be 100% identical, and the best you can do is come close.

## Chapter 9

- 9.1 Closing a file writes or flushes to disk any data held in DOS buffers, updates the entry for this file in the disk directory, and releases the file handle for use with other files.
- 9.2 Opening a file is required before you can read and write data in the file. Unless an error occurs, when DOS opens a file, it returns a file handle that you can subsequently use to refer to the opened file.

### 9.3 DATASEG

```
prompt db 'File? ', 0
string db 65 dup (0)
```

### CODESEG

```
; Input : none
; Output: cf = 0 : ax = file handle, string = file name
; cf = 0 : ax = error code (or 0 if no file
; entered)
; Regs : ax, cx, di
```

### PROC OpenFile

```
 mov di, offset prompt ; Address prompt string
 call StrWrite ; Display prompt
 mov di, offset string ; Address input string
 mov cx, 64 ; Limit to 64 characters
 call StrRead ; Get file name
 call StrLength ; Check length in cx
 jcxz @@10 ; Exit if length = 0
 mov dx, di ; Address string with ds:dx
 mov ah, 03Dh ; DOS Open-File function
 mov al, 2 ; 2 = Read/Write access
 int 21h ; Call DOS to open file
 ret ; Return (cf = result)
```

### @@10:

```
 xor ax, ax ; No error code in this case
 stc ; Set carry to indicate file is not
 ; open
 ret ; Return to caller
```

### ENDP OpenFile

- 9.4 ; Input : bx=file handle; dx=address of file name
- ; Output : File flushed and reopened. (Location changed
- ; to beginning of file.) cf=0:no errors; cf=1:error
- ; Regs : ax

### PROC FlushFile

```

 mov ah, 03Eh ; DOS Close-File function number
 int 21h ; Call DOS to close the file
 jc @@99 ; Exit on errors
 mov ah, 03Dh ; DOS Open-File function
 mov al, 2 ; 2 = Read/Write access
 int 21h ; Call DOS to open file
@@99:ret ; Return (cf = result)
ENDP FlushFile

```

9.5 ; Input : cx=record size; ax=record number; bx=file handle  
; : ds:dx=address of buffer  
; Output : cf=1:error (ax = code); cf=0:success  
; Regs : ax

```

PROC ReadRecord
 push cx ; Save record size
 push dx ; Save buffer address
 mul cx ; ax:dx <- ax * cx
 mov cx, dx ; cx <- MSW of result
 mov dx, ax ; dx <- LSW of result
 mov ah, 042h ; DOS Seek-File function
 mov al, 0 ; Seek from beginning of file
 int 21h ; Position file pointer
 jc @@99 ; Exit on errors
 mov ah, 03Fh ; DOS Read-File function
 pop dx ; Retrieve buffer address
 pop cx ; Retrieve record size
 int 21h ; Read cx bytes from file
@@99:ret ; Return to caller
ENDP ReadRecord

```

9.6 ; Input : cx=record size; bx=file handle  
; : ds:dx=address of buffer  
; Output : cf=1:error (ax = code); cf=0:next record loaded  
; Regs : cx, dx

```

PROC ReadNextRec
 push cx ; Save record size
 push dx ; Save buffer address
 mov dx, cx ; dx <- cx
 xor cx, cx ; Zero upper half of value
 mov ah, 042h ; DOS Seek-File function
 mov al, 1 ; Seek from current position
 int 21h ; Position file pointer
 mov ah, 03Fh ; DOS Read-File function
 pop dx ; Retrieve buffer address
 pop cx ; Retrieve record size
 int 21h ; Read cx bytes from file
 ret ; Return to caller

```

```

ENDP ReadNextRec

```

**9.7** ; Input : ah=option letter e.g., 'P' (case sensitive)  
 ; Note : Must have called GetParams earlier  
 ; Output : cf=1:not found; cf=0:option (e.g., -P) found  
 ; Regs : al, cx, di

```
PROC OptionLetter
 call ParamCount ; dx=number of parameters
 mov cx, dx ; Transfer num to cx
@@10:
 jcxz @@99 ; Exit if all params checked
 dec cx ; Count number params done
 push cx ; Save count on stack
 call GetOneParam ; Get param addr in di
 call StrLength ; Get length of param string
 cmp cx, 2 ; Test string length
 pop cx ; Restore count from stack
 jb @@10 ; Jump if length < 2 chars
 mov al, '-' ; al='-'; ah=option letter
 scasw ; Compare ax with [ds:di]
 jnz @@10 ; Jump if compare fails
 cld ; Clear carry
 ret ; Return success!
@@99:stc ; Set carry
 ret ; Return failure
ENDP OptionLetter
```

**9.8** ; Add these variables to DR.ASM between lines 18 and 19  
 oneDot DB '.', 0 ; Single dot string  
 oneBlank DB '', 0 ; Single blank string

```
; Insert this procedure between lines 129 and 130 and
; also insert a call ExpandName instruction between
; lines 117 and 118
```

; Input : ds:di addresses file name in directory DTA  
 ; Output : name expanded, e.g., xxx.txt --> xxx txt

```
PROC ExpandName
 mov si, offset OneDot ; Address '.' string
 call StrPos ; Is there a '.' here?
 jnz @@05 ; Jump if no
 cmp dx, 0 ; But is '.' at front?
 jne @@10 ; Jump if no
@@05:
 call StrLength ; Get string length
 mov dx, cx ; And assign to dx
 jmp short @@20 ; Skip delete steps next
@@10:
 mov cx, 1 ; Number of chars to delete
 call StrDelete ; Delete '.' (if there)
@@20:
 mov si, offset OneBlank; Address '' string
```

```

@@30:
 call StrLength ; Get string length
 cmp cx, 12 ; Is length = 12 yet?
 je @@99 ; Exit if yes
 call StrInsert ; Insert blank into string
 jmp @@30 ; Repeat until done
@@99:
 ret ; Return to caller
ENDP ExpandName

```

**9.9** ; Insert into KOPY.ASM between lines 115 and 116:

```

 mov al, [oneByte] ; Get input byte
 cmp al, ' ' ; Is byte >= ' '?
 jge @@Continue ; Jump if yes (not a control)
 cmp al, 13 ; Is byte a carriage return?
 je @@Continue ; Jump if yes
 mov al, ' ' ; Change controls to blanks
 mov [oneByte], al ; Store char back in variable

```

@@Continue:

**9.10** ; Add these lines to DR.ASM between lines 18 and 19

```

comExtn DB .COM, 0 ; .COM file extension
exeExtn DB .EXE, 0 ; .EXE file extension
; Replacement for Action procedure in DR.ASM, lines
; 116-128
PROC Action
 push si ; Save si
 mov di, offset dirData + FileName ; Address filename
 mov si, offset comExtn ; Check for .COM extensions
 call StrPos ; Is '.COM' there?
 jz @@05 ; Jump if yes
 mov si, offset exeExtn ; Check for .EXE extensions
 call StrPos ; Is '.EXE' there?
 jnz @@99 ; Exit if no

```

@@05:

```

 call ExpandName ; OPTIONAL: see answer to question #9.8

```

```

 call StrWrite ; Write file name
 call StrLength ; Tab to next column
 sub cx, 16
 neg cx

```

@@10:

```

 mov ah, 2
 mov dl, ' '
 int 21h
 loop @@10

```

```

@@99: pop si ; Restore si
 ret ; Return to caller
ENDP Action

```





## Chapter 10

- 10.1** External interrupts can occur at any time; therefore, changing a register could destroy a value being used by the interrupted program.
- 10.2** An `iret` instruction pops the flags and return address off the stack, resuming the program with the instruction just after the place where the interruption occurred.
- 10.3** The `cld` instruction disables maskable interrupts. The `sti` instruction enables maskable interrupts. Both instructions operate by clearing and setting the interrupt-enable flag `if`. In an ISR, a `cld` instruction could appear anywhere but is unnecessary because interrupts are disabled when the ISR begins to run. An `sti` instruction should appear near the beginning of the ISR if you want interrupts to be recognized during the ISR's execution. Placing an `sti` before `iret` is always unnecessary because ending the interrupt restores the `if` flag to its previous state.

### 10.4 DATASEG

```
oldSeg dw ? ; Stores original vector segment
oldOfs dw ? ; Stores original vector offset
```

### CODESEG

```
;----- Install new vector
push ds ; Save ds register
push es ; Save es register
mov ax, 351Ch ; Get interrupt 1C vector
int 21h ; Call DOS for vector
mov [oldSeg], es ; Save segment value
mov [oldOfs], bx ; Save offset value
mov ax, 251Ch ; Set interrupt 1C vector
push cs ; Make ds = cs to address
pop ds ; the new ISR, placing full
mov dx, offset NewISR; address into ds:dx
int 21h ; Set new interrupt vector
pop es ; Restore es
pop ds ; Restore ds

;----- Restore original vector
push ds ; Save ds, changed below
mov ax, 251Ch ; Set interrupt 1C vector
mov dx, [oldOfs] ; Get saved offset value
mov ds, [oldSeg] ; Get saved segment value
int 21h
pop ds ; Restore ds
```

- 10.5** Yes, but you have to execute an `sti` instruction to set the interrupt-enable flag, allowing maskable interrupts to be recognized.

```

10.6 sti ; Enable interrupts
 mov al, 020h ; End-of-interrupt value
 out 020h, al ; Output to 8259 port

10.7 PROC PrintScreen
 int 5 ; Call "hardware" interrupt 5
 ret ; Return to caller
 ENDP PrintScreen

```

**10.8** When a divide fault occurs, causing an interrupt type 0 signal, the 8086/88 processors push the address of the next instruction after the `div` or `idiv` that caused the fault. The 80286/386 and later processors push the address of the divide instruction.

```

10.9 int 3 ; Set breakpoint

```

```

10.10 ;----- Set trap flag (tf)
 push bp ; Save bp
 pushf ; Push flags onto stack
 mov bp, sp ; Address stack with bp
 or [word bp], 0100h ; Set tf in saved flags
 popf ; Restore flags from stack
 pop bp ; Restore bp

```

## Chapter 11

**11.1** There would be 8 digits in a hypothetical packed 4-byte BCD value (2 digits per byte). There would be 6 digits in a hypothetical 6-byte unpacked BCD value (1 digit per byte). The `dt` directive allocates 10 bytes. At 2 digits per byte, that's enough room to hold up to 20 packed BCD digits.

```

11.2 mov al, 079h ; Assign packed BCD to al
 mov ah, al ; Copy value to ah
 mov cl, 4 ; Assign shift count to cl
 shr ah, cl ; Shift BCD MSD to LDS position
 and al, 00Fh ; Mask other digit in al
 aad ; Convert unpacked BCD to binary

```

The trick here is to convert the packed BCD byte in `al` to unpacked form in `ax` (1 digit per byte), using `shr` and `and` instructions to manipulate the bits. With the data in this format, `aad` converts the value to binary in `ax`.

```

11.3 GLOBAL string:Byte ; or, GLOBAL string:Byte:25
 GLOBAL count:Word
 GLOBAL BCD:TByte

```

The string GLOBAL definition can also be `string:Byte:25`, although it's not necessary in this case to specify the exact length of the string variable.



**11.4 DATASEG**

```
cubes db 0, 1, 8, 27, 64, 125, 216 ; cubes of 0 to 6
CODESEG
mov al, cl ; Copy index in cl to al
mov bx, offset cubes ; Address table with ds:bx
xlat ; Translate al from table
```

**11.5** ASSUME tells Turbo Assembler where a specified segment register points. Using ASSUME lets the assembler verify that references to named variables are correct.

**11.6** SEGMENT MoreData Page Public 'DATA'

```
MyWord dw 1234h
ENDS MoreData
```

## CODESEG

```
mov ax, MoreData ; Address MoreData segment
mov ds, ax ; with ds
ASSUME ds:MoreData ; Tell Turbo Assembler where ds points
mov ax, [MyWord] ; Load ax with value of MyWord
```

**11.7** GROUP combines multiple segments that have different names and, possibly, different classes, into one segment up to 64K long. To group the four listed segments under the name DataGroup, use the command:

```
GROUP DataGroup SomeData, MoreData, TableSeg, StringSeg
```

Then you can address the data in the grouped segment by first initializing a segment register to the start of the group:

```
mov ax, DataGroup
mov ds, ax
ASSUME ds:DataGroup
```

**11.8** Execute these commands to assemble, link, and run the program, which calls a procedure in the STRIO library module:

```
tasm capslock
tlink capslock,, mta
capslock
```

**Listing Answers.2. CAPSLOCK.ASM.**

```
1: %TITLE "Test CapsLock Key -- by Tom Swan"
2:
3: IDEAL
4: MODEL small
5: STACK 256
6:
7: BIOSDataLoc EQU 0040h ; Segment address of BIOS data
8: KbFlagLoc EQU 017h ; Offset to keyboard flag
9: CapsLockFlag EQU 040h ; Capslock key bit
10:
11: SEGMENT BIOSData at BIOSDataLoc
12: ORG KbFlagLoc
```

```

13: LABEL KbFlag Byte
14: ENDS BIOSData
15:
16: DATASEG
17:
18: CapsString db 'CapsLock is: ', ,0
19: CapsOn db 'ON', 0
20: CapsOff db 'OFF', 0
21:
22: CODESEG
23:
24: EXTRN StrWrite:proc
25:
26: ASSUME DS:BIOSData
27:
28: Start:
29: mov ax, BIOSDataLoc ; Address BIOSData segment
30: mov es, ax ; with es
31: ASSUME es:BIOSData ; Tell tasm where es points
32: mov bl, [es:KbFlag] ; Load keyboard flag into bl
33: mov ax, @data ; Initialize ds and es
34: mov ds, ax ; to default data segment
35: mov es, ax
36: ASSUME es:@data, es:@data ; Tell tasm where es, ds point
37: mov di, offset CapsString ; Address string with di
38: call StrWrite ; Display string
39: mov di, offset CapsOn ; Address "ON" with di
40: test bl, 040h ; Test capslock flag bit
41: jnz @@10 ; Jump if bit <> 0
42: mov di, offset CapsOff ; Else address "OFF" with di
43: @@10:
44: call StrWrite ; Display "ON" or "OFF"
45: mov ax, 04C00h ; DOS function: Exit program
46: int 21h ; Call DOS. Terminate program
47:
48: END Start ; End of program / entry point

```

**11.9** P286N

```

PROC ISR286
 pusha ; Push all general-purpose registers
;
; Other code goes here
;
 popa ; Pop all general-purpose registers
 iret ; Return from interrupt
ENDP ISR286

```

- 11.10** This problem reduces to two tasks: Transfer a certain bit to the carry flag and then either do nothing to the original bit *bt*, complement the bit *btc*, reset the bit *btr*, or set the bit *bts*. The following shows how to accomplish these tasks for bit 3. Other bits require different mask values, but the code is the same.

# C

```
;----- To transfer bit 3 (mask = 0008h) to cf:

 test dx, 08h ; zf <- result; cf <- 0
 jz @@10 ; Jump if bit = 0
 stc ; Else set carry
@@10:

;----- Then, to complement, reset and set bit 3:

 xor dx, 08h ; Complement bit 3
 and dx, NOT 08h ; Reset bit 3
 or dx, 08h ; Set bit 3
```

## Chapter 12

**12.1** *Critical code* refers to program statements that account for most of a program's total execution time.

**12.2** A profiler monitors a running program and prepares statistics that can help identify the programs critical code.

**12.3** `InLine($F8); { clc -- clear carry flag }`  
`InLine($F9); { stc -- set carry flag }`

```
PROCEDURE clc; InLine($F8); { clear carry flag }
PROCEDURE stc; InLine($F9); { set carry flag }
```

**12.4** `PUBLIC PlayBall`  
`PROC PlayBall FAR`  
`ret ; Return to caller`  
`ENDP PlayBall`

Did you remember to declare this procedure FAR, required because of the Pascal { $F+$ } declaration?

**12.5** `{ $L$  NEWSTUFF.OBJ}`  
`PROCEDURE OldStuff; EXTERNAL;`  
`FUNCTION OlderStuff : Integer; EXTERNAL;`

**12.6** Using the TPASCAL memory model adds `push bp` and `mov bp, sp` instructions to every procedure, whether or not these instructions are needed to address parameters on the stack. The advantage of the TPASCAL memory model is the ability it gives you to use simplified segment directives `DATASEG` and `CODESEG` in external modules. The alternative is to declare segments manually with `SEGMENT` directives, also requiring the use of `ASSUME` to inform the assembler to which memory segments `cs`, `ds`, and `es` refer. TPASCAL is not required with Borland Pascal.

**12.7** Plain constants and types such as `Months`, `MaxLevel`, and `Esc` identifiers can't be imported into an assembly language module. The other declarations can be imported into a data segment this way:



```

SEGMENT DATA word public
 EXTRN AreaCode : WORD, YourName : BYTE,
 Score : WORD
 EXTRN SalesPerMonth : WORD
ENDS DATA

```

**12.8** In the Pascal program:

```

PROCEDURE WriteASCII; FORWARD;
{$L ASCII.OBJ}

```

In the object-code module:

```

SEGMENT CODE byte public
ASSUME cs:CODE, ds:DATA
EXTRN WriteASCII : NEAR
PROC AnyProc NEAR
 mov ax, 'a' ; Pass character as word
 push ax ; on stack
 call WriteASCII ; Call Pascal procedure
 ret
ENDP AnyProc
ENDS

```

**12.9**

```

mov ax, [word LongValue]
mov dx, [word LongValue + 1]
ret

```

**12.10** The assembly language module, TESTASM.ASM:

```

IDEAL
MODEL TPASCAL
CODESEG
PUBLIC LotsOfParams

PROC LotsOfParams NEAR
 ARG a:Word, b:Word, Number:dword, char:dword
 mov cx, [a] ; Load a into cx
 mov dx, [b] ; Load b into dx
 les di, [Number] ; Address Number with es:di
 add [word es:di], 5 ; Add 5 to number
 les si, [char] ; Address ch with es:si
 mov al, [byte es:si]; Load ch into al
 ret ; Return to caller
ENDP LotsOfParams

END ; End of module

```

The Pascal program, TESTPAS.PAS:

```

PROGRAM TestPas;
VAR Score : Integer; ch : char;

```

*continues*



```
{$.L TESTASM.OBJ}
PROCEDURE LotsOfParams(a,b : Integer; VAR number :
 Integer; VAR ch : char); EXTERNAL;
BEGIN
 ch := 'A';
 score := 100;
 Writeln('Before score = ', score);
 LotsOfParams(1, 2, score, ch);
 Writeln('After score = ', score)
END.
```

## Chapter 13

- 13.1** The two methods of adding assembly language to C programs are: inline `asm` statements and external functions. Inline statements require Turbo C to compile the entire program into an `.ASM` text file and then assemble and link this file separately. External functions are assembled separately and then linked with a compiled Turbo C program in `.OBJ` code-file format. Borland C++ can assemble inline `asm` statements directly.
- 13.2** External functions must save and restore `si` and `di` (if these registers are used), but only if another function using register variables calls the external code. It is never necessary to save and restore `si` and `di` in C functions that use inline `asm` statements. In that case, the compiler automatically saves and restores these registers while also turning off register variables, thus preventing any possibility of a conflict.
- 13.3** To compile this program, supplied on the disk in file `CFLAGS.C`, enter `bcc cflags.c` or `tcc cflags`.

```
#pragma inline
#include <stdio.h>

void showflags(void);

int main()
{
 showflags();
 return 0;
}

void showflags(void)
{
 unsigned int theflags;

 printf("- - - O D I T S Z - A - P - C\n");
 asm pushf /* push flags onto stack */
 asm pop [theflags] /* pop flags into the flags */
```

```

asm mov cx, 16 /* assign loop count to cx */
Again:
asm rol [Word ptr theflags], 1 /* rotate bit to LSD position */
asm push cx /* save loop count on stack */
printf("%d", (theflags & 1)); /* display value of LSD */
asm pop cx /* restore saved loop count */
asm loop Again /* repeat until done */
printf("\n"); /* start new output line */
}

```

**13.4** `asm lea bx, MyThings.OneThing`

**13.5** Use the `-S` option (the S must be in uppercase) to compile a program to assembly language text. For example, to compile CHECKERS.C, you could use the command:

```
tcc -S checkers
```

For Borland C++, enter:

```
bcc -S checkers.c
```

The result is a file named CHECKERS.ASM containing the program in assembly language form. The danger of this command is that any existing CHECKERS.ASM file is erased with no prior warning.

**13.6** Using Borland C++ as a front end to Turbo Linker:

```

tasm /ml func1
tasm /ml func2
bcc -c main
bcc -ms main.obj func1.obj func2.obj

```

Or, to link directly, replace the fourth line with:

```
tlink \tc\lib\c0s main func1 func2, main,, \bc4\lib\cs
```

**13.7** ARG source:DWord, destination:DWord, sourcelen:Word

**13.8** `#include <stdio.h>`

```

extern void copystring (unsigned char far * source,
 unsigned char far * destination,
 int sourcelen);

char *source = "Source";
char *destination = "Destination";

main()
{
 printf("Before destination: %s\n", destination);
 copystring(source, destination, 6);
 printf("After destination : %s\n", destination);
}

```





## 13.9 %TITLE "Copy String External C Function"

```

 IDEAL
 MODEL small

 CODESEG

 PUBLIC _copystring

 PROC _copystring NEAR

 ARG source:DWord, destination:DWord, sourcelen:Word

 push bp ; Save bp
 mov bp, sp ; Address params with bp
 mov cx, [sourcelen] ; Load length into cx
 jcxz @@99 ; Exit if cx = 0
 push ds ; Save ds on stack
 les di, [destination]; Address dest with es:di
 lds si, [source] ; Address source with ds:si
 cld ; Auto-increment si, di
 rep movsb ; Copy source chars to dest
 pop ds ; Restore ds
@@99:
 pop bp ; Restore bp
 ret ; Return to caller
 ENDP _copystring

 END ; End of module

```

```

13.10 DATASEG
string1 db 'A Source String', 0
silen = $ - string1
string2 db 'A Destination String', 0

```

```

CODESEG
;
;
mov ax, silen - 1 ; Load string length into ax
push ax ; Push length parameter
push ds ; Push dest segment address
mov ax, offset string2; Push dest offset address
push ax
push ds ; Push source segment address
mov ax, offset string1; Push source offset address
push ax
call _copystring ; Call external function
add sp, 10 ; Remove parameters from stack

```

## Chapter 14

```
14.1 mov si, offset p2
 CALL si METHOD TPoint:setx, 0
 CALL si METHOD TPoint:sety, 0
```

14.2 Following is just one of many possible answers. On disk, file TRECT.INC is in the OOP subdirectory.

### Listing Answers.3. TRECT.INC.

```
1: %TITLE "TRect object -- by Tom Swan"
2:
3: GLOBAL TRect_getCoords:PROC
4: GLOBAL TRect_setCoords:PROC
5:
6: STRUC TRect METHOD { ; Begin TRect object declaration
7: getCoords:dword = TRect_getCoords ; Get coordinate values
8: setCoords:dword = TRect_setCoords ; Set coordinate values
9: } ; End of method declarations
10: left dw ? ; Coordinates of upper-left and
11: top dw ? ; lower-right corners of
12: right dw ? ; the rectangle
13: bottom dw ?
14: ENDS TRect ; End TRect object declaration
15:
16: CODESEG
17:
18: %NEWPAGE
19: ;-----
20: ; TRect_getCoords TRect getCoords method
21: ;-----
22: ; Input:
23: ; ds:si = instance address
24: ; Output:
25: ; ax = left coordinate
26: ; bx = top coordinate
27: ; cx = right coordinate
28: ; dx = bottom coordinate
29: ; Registers:
30: ; cx, dx, si, di
31: ;-----
32: PROC TRect_getCoords PASCAL
33: mov ax, [(TRect PTR si).left]
34: mov bx, [(TRect PTR si).top]
35: mov cx, [(TRect PTR si).right]
36: mov dx, [(TRect PTR si).bottom]
37: ret
38: ENDP TRect_getCoords
39: %NEWPAGE
40: ;-----
41: ; TRect_setCoords TRect setCoords method
42: ;-----
43: ; Input:
```

*continues*

**Listing Answers.3. continued**

```
44: ; ds:si = instance address
45: ; left coordinate (word, on stack)
46: ; top coordinate (word, on stack)
47: ; right coordinate (word, on stack)
48: ; bottom coordinate (word, on stack)
49: ; Output:
50: ; none
51: ; Registers:
52: ; ax
53: ;-----
54: PROC TRect_setCoords PASCAL
55: ARG @@left:word, @@top:word, @@right:word, @@bottom:word
56: mov ax, [@@left]
57: mov [(TRect PTR si).left], ax
58: mov ax, [@@top]
59: mov [(TRect PTR si).top], ax
60: mov ax, [@@right]
61: mov [(TRect PTR si).right], ax
62: mov ax, [@@bottom]
63: mov [(TRect PTR si).bottom], ax
64: ret
65: ENDP TRect_setCoords
```

```
14.3 PROC TAnyObject_twoWords PASCAL ; Declare procedure
 ARG @@w1:WORD, @@w2:WORD ; Specify required arguments
 USES cx, dx ; Preserve used registers
 mov cx, [@@w1] ; Load argument 1 into cx
 mov dx, [@@w2] ; Load argument 2 into dx
 ;---- Insert other instructions here
 ret ; Return to caller
 ENDP TAnyObject_twoWords
```

14.4 First, set `si` to the offset address of an instance, `v`, of the `TAnyObject` object, then call the `AnyStatic` method as shown on the second line:

```
mov si, offset v
CALL si METHOD TAnyObject:AnyStatic
```

14.5 Compare the following code with the static function call in the preceding exercise. In both cases, the program addresses the object instance `v` with `si`, but the virtual call requires two steps. First, load register `es` with the segment address of the object's virtual method table (required only for small memory model programs). This assumes that the program also includes the `OOMACROS.INC` file. Next, call the virtual method as shown on the third line. In Ideal mode, it is necessary to preface the use of register `si` with `TAnyObject PTR`, which tells the assembler the type of object that the register addresses:



```

mov si, offset v
LoadVMTSeg es
CALL TAnyObject PTR si METHOD TAnyObject:AnyVirtual

```

- 14.6** Listing Answers.4, TDATEOBJ.INC, shows one way to create an object, TDateObj derived from TItem, that can store day, month, and year values. On disk this file is stored in the OOP subdirectory.

#### Listing Answers.4. TDATEOBJ.INC.

```

1: %TITLE "TDateObj object -- by Tom Swan"
2:
3: GLOBAL TDateObj_construct:PROC
4: GLOBAL TDateObj_init:PROC
5: GLOBAL TDateObj_setDate:PROC
6: GLOBAL TDateObj_getDate:PROC
7: GLOBAL TDateObj_print:PROC
8:
9: STRUC TDateObj Titem METHOD {
10: construct:mptr = TDateObj_construct ; TDateObj constructor
11: init:mptr = TDateObj_init ; TDateObj initializer
12: setDate:mptr = TDateObj_setDate ; Change or initialize date
13: getDate:mptr = TDateObj_getDate ; Get day, month, year data
14: VIRTUAL print:mptr = TDateObj_print ; Print or display item
15: }
16: year dw ?
17: day dw ?
18: month db ?
19: ENDS TDateObj
20:
21: Make_VMT ; Define TDateObj VMT
22:
23: DATASEG
24:
25: dayBuf db '00'
26: daySep db '/'
27: monthBuf db '00'
28: monthSep db '/'
29: yearBuf db '0000', 0
30: TDateObj_msg db 'Date item = ', 0
31:
32: CODESEG
33:
34: ;----- From BINASC.OBJ, STRIO.OBJ
35: EXTRN BinToAscDec:Proc, NewLine:Proc, StrWrite:Proc
36:
37: ;-----
38: ; TDateObj_construct TDateObj constructor
39: ;-----
40: ; Input:
41: ; ds:si = TDateObj instance address
42: ; Output:
43: ; VMT ptr initialized
44: ; Registers:

```

## Listing Answers.4. continued

```

45: ; none
46: ;-----
47: PROC TDateObj_construct PASCAL
48: TBLINIT TDateObj PTR si ; Initialize VMT pointer
49: ret
50: ENDP TDateObj_construct
51:
52: ;-----
53: ; TDateObj_init Initialize item "next" pointer
54: ;-----
55: ; Input:
56: ; ds:si = TDateObj instance address
57: ; Output:
58: ; instance data bytes set to zero
59: ; Registers:
60: ; ax
61: ;-----
62: PROC TDateObj_init PASCAL
63: CALL si METHOD Titem:init
64: CALL si METHOD TDateObj:setDate, 0, 0, 0
65: ret
66: ENDP TDateObj_init
67:
68: ;-----
69: ; TDateObj_setDate Change or initialize a TDateObj instance
70: ;-----
71: ; Input:
72: ; ds:si = TDateObj instance address
73: ; year (word, on stack)
74: ; day (word, on stack)
75: ; month (word, on stack)
76: ; Output:
77: ; arguments stored in TDateObj instance
78: ; Registers:
79: ; ax
80: ;-----
81: PROC TDateObj_setDate PASCAL
82: ARG @@year:WORD, @@day:WORD, @@month:WORD
83: mov ax, [@@year]
84: mov [(TDateObj PTR si).year], ax
85: mov ax, [@@day]
86: mov [(TDateObj PTR si).day], ax
87: mov ax, [@@month]
88: mov [(TDateObj PTR si).month], ax
89: ret
90: ENDP TDateObj_setDate
91:
92: ;-----
93: ; TDateObj_getDate Return a TDateObj instance's data
94: ;-----
95: ; Input:
96: ; ds:si = TDateObj instance address
97: ; Output:
98: ; ax = instance.year
99: ; cx = instance.day
100: ; dl = instance.month

```

```

101: ; Registers:
102: ; ax, cx, dl
103: ;-----
104: PROC TDateObj_getDate PASCAL
105: mov ax, [(TDateObj PTR si).year]
106: mov cx, [(TDateObj PTR si).day]
107: mov dl, [(TDateObj PTR si).month]
108: ret
109: ENDP TDateObj_getDate
110:
111: ;-----
112: ; TDateObj_print Print item VIRTUAL
113: ;-----
114: ; Input:
115: ; ds:si = TDateObj instance address
116: ; Output:
117: ; none
118: ; Registers:
119: ; none
120: ;-----
121: PROC TDateObj_print PASCAL
122: USES ax, cx, di, es ; Preserve registers
123:
124: push ds ; Set es equal to ds
125: pop es ; for extrn subroutines
126: mov di, offset TDateObj_msg ; Address label string
127: call StrWrite ; Display string
128:
129: mov ax, [(TDateObj PTR si).day]
130: mov cx, 2
131: mov di, offset dayBuf
132: call BinToAscDec
133:
134: mov ah, 0
135: mov al, [(TDateObj PTR si).month]
136: mov cx, 2
137: mov di, offset monthBuf
138: call BinToAscDec
139:
140: mov ax, [(TDateObj PTR si).year]
141: mov cx, 4
142: mov di, offset yearBuf
143: call BinToAscDec
144:
145: mov [daySep], '/'
146: mov [monthSep], '/'
147: mov di, offset dayBuf
148: call StrWrite
149:
150: call NewLine ; Start new display line
151: ret
152: ENDP TDateObj_print

```

14.7 Include the TDATEOBJ.INC file from the preceding exercise:

```
INCLUDE "tdateobj.inc"
```



Define two date instances in the program's data segment. Also define a string for labeling the new code's output:

```
date1 TDateObj <>
date2 TDateObj <>
str6 db 'After inserting date items...', 0
```

Initialize the date instances with these instructions:

```
mov si, offset date1
LoadVMTSeg es
CALL si METHOD TDateObj:construct
CALL si METHOD TDateObj:init
CALL si METHOD TDateObj:setDate, 1954, 12, 7
```

```
mov si, offset date2
LoadVMTSeg es
CALL si METHOD TDateObj:construct
CALL si METHOD TDateObj:init
CALL si METHOD TDateObj:setDate, 1998, 02, 15
```

Insert the date instances on the list and call `DisplayItems` to display them along with the other items:

```
mov si, offset list
LoadVMTSeg es
mov ax, offset date1
call InsertItem
mov ax, offset date2
call InsertItem
mov di, offset str6
call DisplayItems
```

## Chapter 15

- 15.1** There are two answers. If you specify the large memory model along with `WINDOWS` and `PASCAL` in a `MODEL` directive, you may use this short-form declaration:

```
EXTRN Ellipse:PROC
```

Alternatively, for the large and all other memory models, you may use the full declaration:

```
EXTRN PASCAL Ellipse:FAR
```

- 15.2** Define a string buffer and a symbol that represents the buffer's size in bytes. Insert the declarations in the program's uninitialized data segment (you could also insert them in the initialized segment after a `DATASEG` directive, but that would needlessly expand the program's code file by 144 bytes):

```

UDATASEG
szSysPath db 144 dup(?) ; String buffer
cbSysPath = $ - szSysPath ; Size of buffer in bytes

```

Also declare the `GetWindowsDirectory` function in an `EXTRN` directive:

```
EXTRN PASCAL GetWindowsDirectory:FAR
```

Call the function by passing it the two data arguments. `GetWindowsDirectory` returns the number of characters inserted into the buffer, not including the null terminator, which the function appends to the string. Call the function as follows, either in response to a menu command or at any place after the program calls `AppInit` (or you could add the code to the end of that subroutine):

```

push ds ; Push segment of szSysPath buffer
push OFFSET szSysPath ; Push offset of szSysPath buffer
push cbSysPath ; Push length of buffer in bytes
call GetWindowsDirectory ; Call Windows function

```

### 15.3 Change line 96 from this:

```
mov [cmdShow], dx
```

To this:

```
mov [cmdShow], SW_SHOWMAXIMIZED
```

**15.4** The best place to insert the instructions is immediately after the `@@WMDESTROY` label in the `WndProc` subroutine. Regardless of how the user quits the program, this section of code is guaranteed to execute and sound the beep. Did you also remember to declare the `MessageBeep` function `EXTRN`?

**15.5** First add the following definition to the program's uninitialized data segment (after the `UDATASEG` directive):

```
wMainHnd DW ?
```

Then, insert this instruction after line 193 in `WINAPP.ASM` in the `AppInit` subroutine:

```
mov [wMainHnd], ax
```

**15.6** The "un-Windows" answer simply calls the `HelpAbout` subroutine. Although this may work (depending on where you insert the call), the preferred approach is to send the window a message that simulates the *HelpAbout* command. You can do that with the following instructions, which you can insert into `WinMain` immediately after the call to `AppInit`:

```

push [wMainHnd] ; Push main window handle (see exercise 15.5)
push WM_COMMAND ; Push message value
push CM_HELP_ABOUT ; Push command identifier for message
push 0 ; Push unused long parameter (high word)
push 0 ; Push unused long parameter (low word)
call SendMessage ; Send message to simulate menu-command selection

```



---

# Bibliography

---

**Borland International** Turbo Assembler 4.0, Turbo Debugger 4.0, Turbo Pascal, Turbo C++, Borland C++. Scotts Valley, CA.

Programs in this book were tested with the most recently available versions. Some versions of Pascal, C, and C++ are supplied with Turbo Assembler. Version 4.0 of Turbo Assembler is also available by separate purchase from Borland.

**Brief** *Borland International*. CA.

I used *Brief* to write all the programs in this book as well as the text for the chapters. There are many good programming editors on the market, but you won't go wrong if you choose this one.

**Campbell, Joe** *C Programmers Guide to Serial Communications*, Second Edition. Indianapolis, IN: Sams Publishing, 1994.

Every programmer who plans to write communications software in *any* language should read this superb book. Note: A C compiler is required—the author uses Aztec C, although your favorite compiler will probably work if you don't mind making a few alterations to the listings.

**Duncan, Ray** *Advanced MS-DOS*. Redmond, WA: Microsoft Press, 1986.

This is one of the best MS-DOS programming books around. It contains many assembly language examples plus well-organized MS-DOS and IBM PC BIOS function references and includes an especially good chapter that explains how to write installable device drivers.

**Intel Corporation** *iAPX 86/88, 186/188 User's Manual—Programmer's Reference*. Santa Clara, CA, 1986.

Serious assembly language programmers should consider purchasing this and the next technical references from Intel, makers of the 8086, 8088, 80186, 80286, 80386, 80486, and other processors—among other products. Despite errors here and there, the references list complete details about machine-code bit formats and instruction timings—data that you may need for detailed assembly language work. Helpful pseudocode listings describe how individual instructions operate. You probably won't find these references in book stores; for more information, write to: Intel Literature Sales, P.O. Box 58130, Santa Clara, CA 95052-8130. In the U.S. and Canada, you may order these references by calling the toll-free number, (800) 548-4725.

**Intel Corporation** *80286 and 80287 Programmer's Reference Manual*. Santa Clara, CA, 1987.

**Intel Corporation** *80386 Programmer's Reference Manual*. Santa Clara, CA, 1987.

**Intel Corporation** *i486 Microprocessor Programmer's Reference Manual*. Santa Clara, CA, 1990.

**Jensen, K., and Wirth, N.** *Pascal User Manual and Report*, 2nd ed. New York: Springer-Verlag, 1974.

This is the book that started the Pascal ball rolling. Now seriously out of date, the reference is useful primarily as a general guide to designing portable programs in standard Pascal that you plan to optimize with assembly language using the methods discussed in Chapter 12. Beware: Some standard procedures such as `get` and `put` are not supported by Turbo Pascal.

**Kernighan, B., and Ritchie, D.** *The C Programming Language*, 2nd ed. Englewood Cliffs: Prentice Hall, 1988.

Every beginning C programmer should read this tutorial from cover to cover. Like the Jensen and Wirth Pascal guide, Kernighan and Ritchie (the popular alternate title for the book) is especially useful as a guide to designing portable programs in standard C that you plan to optimize with assembly language using the methods discussed in Chapter 13.

**Microsoft Corporation** *Microsoft Macro Assembler 5.1 Reference*. Redmond, WA, 1987.

If you have Turbo Assembler, you don't need to purchase the Microsoft Macro Assembler. But if you don't mind paying for two assemblers, the MASM references are well written and make useful additions to your programming library. Note: MASM does not support Turbo Assembler's Ideal mode.

**Strauss, Edmund** *80386 Technical Reference*. New York, NY: Brady, 1987.

A general guide to the 80386, this book duplicates much of the material in the Intel *80386 Programmer's Reference Manual*. Even so, you'll find some good information here on using protected-mode instructions.

**Swan, Tom** *Mastering Turbo Pascal 6.0*, Fourth Edition. Indianapolis, IN: Howard W. Sams, 1988.

See Chapter 14, "Pascal Meets Assembly Language", for more information about adding inline assembly language to Turbo Pascal. Note: This chapter was written before Turbo Assembler existed.

**Tanenbaum, Andrew S.** *Operating Systems: Design and Implementation*. Englewood Cliffs, NJ: Prentice-Hall, Inc., 1987.

Beyond a doubt, this is one of the best (maybe *the* best) book ever written about multitasking, multiuser operating systems. The text is witty and accurate but highly technical at times. Although the content is aimed at C programmers and contains very little assembly language code, understanding the book's content is a prerequisite to getting started with 80386 protected-mode programming of multitasking operating systems.

**The Waite Group** *The Waite Group's MS-DOS Papers*. Indianapolis, IN: Howard W. Sams, 1988.

Many assembly language examples and interesting tidbits from several different authors make for interesting reading. It contains useful hints about IBM PC and assembly language programming.



# Index

---

## Index Section

---

### Symbols

---

- , (commas), macro parameters, 303
- ! (exclamation point), macro string characters, 307
- % (percent sign), expression evaluate operator, 306
- %NOLIST command, 331
- & (substitute operator), 304, 306
- :: (double semicolons), macro comments, 301
- < (I/O redirection character), 264-298
- < > (angle brackets), macro expressions, 305
- = (equal sign), defining conditional symbols, 316
- > (I/O redirection character), 264-298
- | (I/O redirection character), 264-298
- 0 (zero), string instructions, 138
- 0040h function, 359
- 03Dh function, 339
- 03Eh function, 341
- 03Fh function, 359
- 042h function, 360
- 04Ch function, 339
- 059h function, 342
- 16-bit code segments, 483
- 16-bit integers (OOP), 633
- 286 microprocessors
  - instructions, 463
  - programming, 461-468
- 32-bit code segments
  - doublewords, converting to 64-bit quadwords, 472
  - instructions, 483
  - interrupts, 483
  - shifting registers, 474
- 386 microprocessors
  - bits
    - scanning/setting, 470
    - testing, 472
  - instructions, 470-474
  - programming, 468-474
  - rotate instructions, 483

shift instructions, 483  
 Turbo Debugger, 37-38  
**45h function, 340**  
**486 microprocessors (Turbo Debugger), 37-38**  
**80286 processors, inline statements (C), 538**  
**80386 processors, inline statements (C), 538**  
**8086 processors**  
   data transfer (mov), 80-90  
   instructions, 126-131  
     *flags, 127*  
     *JUMPS directive, 130-131*  
     *nop, 128-130*  
     *synchronization, 128*  
   memory segmentation, 74  
     *offsets, 76*  
     *paragraphs, 75-76*  
   registers, 76-79  
     *flags, 79*  
     *general-purpose, 77*  
     *index, 77-78*  
     *instruction pointer (ip), 79*  
     *pointer, 77-78*  
     *segments, 78*  
   string instructions, 131-139  
     *addressing labels, 135*  
     *comparing, 138-139*  
     *index registers, 132-133*  
     *loading, 133-134*  
     *memory, 136-137*  
     *mnemonics, 134*  
     *moving, 136*  
     *scanning, 137-138*  
     *storing data, 135*  
     *zero, 138*  
**8259 processor (interrupts), 372-376**

---

**A**

**\_ASMFillBuffer function, 576**  
**aaa (Adjust After Addition) instruction, 426, 709-710**  
**aad (Adjust Before Division) instruction, 427, 710**  
**aam (Adjust After Multiplication) instruction, 427, 710-711**  
**aas (Adjust After Subtraction) instruction, 426, 711**  
**About command (Help menu), 695**  
**absolute values**  
   integers, 61  
   two's complement, 64  
**access operand, segments (programs), 447**  
**accessing**  
   asm statements (C variables), 538-544  
   class objects, 576-578  
   far data segment variables, 459  
**adc (Add With Carry) instruction, 711-712**  
**add (Add Without Carry) instruction, 712-713**  
**adding BCD values, 435**  
**addition operators, 92-93**  
**addresses, 26**  
   arrays, 209  
     *multibyte, 211-213*  
   binary, 59  
   bytes, 55  
   code segments (programs), 508-509  
   flow-control, 110-126  
     *jumps, 119-126*  
     *return instructions, 116*  
     *subroutines, 112-113, 116-119*  
     *unconditional transfers, 112*  
   optimizing, 478  
   parameters, 516-517  
   Pascal variables, 511  
   returning, 482  
   segments (programs), 452  
   stack variables, 515

- typed constants, 509
- variables (verifying), 446
- addressing**
  - labels (string instructions), 135
  - memory, 144-145
    - ASSUME directive*, 150-151
    - base*, 148-149
    - base-indexed*, 149-150
    - direct*, 146
    - indexed*, 149
    - MASM mode*, 150
    - modes*, 145-151
    - overrides*, 146-147
    - register-indirect*, 147-148
- ADDSUB.ASM (listing 4.3), 94-95**
- al registers (values), 339**
- align operand, 447**
- aligning columns (text lines), 27**
- Alt-V-C key command, 443**
- and (Logical AND) instruction, 713**
- AND operator**
  - bits, 103-104
  - masking, 65-66
- ANDORXOR.ASM (listing 4.5), 102-103**
- angle brackets (< >), macro expressions, 305**
- apostrophes, string variables, 158-171**
- application shell (Windows), 679-692**
- applications**
  - binary encodings, 705
  - instruction timings, 705
  - Windows, 655-662
    - creating with TASM*, 679-698
    - dialog boxes*, 696-698
    - naming conventions*, 665
    - pop-up menus*, 693, 695
- ARG directive, 516-517**
  - methods, 601
- arguments**
  - ASMARG.AS (listing 13.9), 566
  - ASMARG2.ASM (listings 13.10), 569-570
  - assembly language, passing to C++, 567-568
  - C++, passing to assembly language, 568
  - CPPARG.CPP. (listing 13.8), 566-569
  - functions
    - declaring automatically*, 569-570
    - passing*, 565-570
  - passing to functions, 480
- arithmetic (math operators), 90-101**
  - addition, 92-93
  - subtraction, 93-94
- arrays, 206-213**
  - addressing, 209
    - multibyte*, 211-213
  - creating with macros, 307
  - displaying, 208
  - errors (accessing), 344
  - indexing, 209-211
  - LABEL directive, 208-209
  - values (translating), 445
- ASCII characters**
  - converting to/from unpacked BCD numbers, 427
  - string formats, 157-158
  - translating to other characters, 443
- ASCIIztoStr procedure, 520**
  - converting to assembly language, 524
- AscToBin subroutine (BINASC.ASM listing 6.3), 236-245**
- AscToNum subroutine (BINASC.ASM listing 6.3), 235-236**
- asm statements (inline statements), 537**
- ASMARG.AS (listing 13.9), 566**
- ASMARG2.ASM (listing 13.10), 569-570**
- ASMFill.AS (listing 13.12), 576-577**
- assembler programs, 4-5**
- assembling**
  - external modules, 551-553
  - modules (programming), 172-173
  - programs, 30-32
    - .COM programs*, 45
    - errors*, 35-37
    - warnings*, 35-37
  - source code (programs), 316



**assembly language, 7-9**

arguments, passing to C++, 567-570  
 attributes, 4-7  
 binary digits, 54  
 bugs, 8

**C**

*debugging*, 554-555  
*global data*, 564-565

C++ classes, 570-578

CFILL.ASM (listing 13.5), 550-551

CFILLSTR.C (listing 13.4), 549-550

classes, accessing objects, 576-578

closing lines, 30

code segments, 27-29

components, 20-30

converting to C, 533

data segments, 24

*initialized variables*, 25

*uninitialized variables*, 25

*variables*, 25-27

data sharing with Pascal, 504-508

data types, adding, 307

DOS, reloading, 45

external assemblies

*simplified memory models*, 545-547

*Turbo Linker*, 544-550

functions

*\_ASMFillBuffer*, 576

*calling*, 549

*calling C functions*, 555-557

*calling C++ functions*, 560-565

*calling from C*, 550-551

*calling from C++*, 562-563

*external*, 563-564

hardware requirements, 9-10

headers, 20-22

inline statements (C), 533-538

*compiling*, 535

*sharing code*, 541-542

library routines, 9

listings, 818-819

local variables, 558-559

operating state, 323

portability, 8-9

software requirements, 10

statements

*actions*, 6-7

*declaring variables*, 539-540

text lines

*columns*, 27, 29-35

*mnemonic column*, 28-29

underscores, 548

UPDOWN.C (listing 13.2), 541-544

variables

*addresses*, 26

*exCode variable*, 27

*labels*, 26

**ASSUME directive**, 451-452, 502, 509

memory-addressing, 150-151

**asterisk (\*)**, 24

**ASYNCH.ASM (listing 10.4)**, 398-404

AsynchIn, 413

Asynchinit, 411

AsynchInStat, 413

AsynchISR, 413-414

AsynchOut, 413

AsynchStop, 412

buffers, 410-411

equates, 410

routines, 409-414

variables, 410

**AsynchIn routine (listing 10.4)**, 413

**Asynchinit (listing 10.4)**, 411

**AsynchInStat routine (listing 10.4)**, 413

**AsynchISR routine (listing 10.4)**,

413-414

**AsynchOut routine (listing 10.4)**, 413

**asynchronous serial I/O**, 397-414

**AsynchStop routine (listing 10.4)**, 412

**At segments**, 456

**attributes (files)**, 345

**B**

**balancing stacks**, 88-89

**base memory-addressing**, 148-149

**base objects (OOP)**, 587-652

**base two values (binary values)**, 57

**base-addresses (arrays)**, 209

**base-indexed memory-addressing,**  
149-150

**BCD (Binary-Coded Decimals),** 206

**BCD.ASM program module (listing 11.1),**  
430-434

**BCDAdd routine (listing 11.1),** 435-436

**BCDCopy routine (listing 11.1),** 438

**BCDs (binary coded decimals),** 206,  
424-429

mathematical operations, 429-438

memory variables, 425

storing, 436

values

*adding, 435*

*displaying/printing, 437*

variables, 434

**BCDSubtract routine (listing 11.1),** 436

**BCDToASCII routine (listing 11.1),**  
437-438

**binary values**

address values, 59

arithmetic, 56, 57-59

base two values, 57

Binary-Coded Decimals (BCD), 206

BINASC.ASM (listing 6.3), 225-231,  
236-239

*EQUIP.ASM (listing 6.4), 237-239*

conversion table, 56-59

CONVERT.ASM (listing 6.5), 241-243

converting, 240-243

*to/from packed BCD numbers, 428-429*

*to/from unpacked BCD numbers, 426*

defaults, 204-206

digits, 54

encodings, 705-706

floating-point numbers, 205-206

hexadecimal values, 59

negative values, 63

RADIX directive, 204-205

rotating, 69

shifting, 69

subtraction, 64

**binary coded decimals, see** BCDs

**BINASC.ASM (listing 6.3),** 225-231

*EQUIP.ASM (listing 6.4), 237-245*

subroutines, 231-237

*AscToBin, 236-237*

*AscToNum, 235-236*

*BinToAscBin, 234-235*

*BinToAscDec, 234-235*

*BinToAscHex, 234-235*

*ChToBase, 235-236*

*HexDigit, 232*

*NumToASCII, 233-234*

*SBinToAscDec, 234-235*

*ValCh, 232-233*

**BinToAscBin subroutine (listing 6.3),**  
234-235

**BinToAscDec subroutine (listing 6.3),**  
234-235

**BinToAscHex subroutine (listing 6.3),**  
234-235

**BIOS (Basic Input-Output System),** 6

**bit fields (unions),** 214

inserting into records, 218-220

isolating values, 217-218

MASK operator, 217

names, 216-217

RECORD directive, 214-216

setting defaults, 215-216

**bits, 54**

386 microprocessors

*scanning/setting, 470*

*testing, 472*

AND operator, 103-104

bytes, 55-56

logical operations, 220-223

*GETFIELD, 221-223*

*instructions, 220-221*

*SETFIELD, 221-223*

LSD (least significant digit), 55

maximum values, 58-59

MSD (most significant digit), 55

OR operator, 66-67

rotating, 69  
 shifting, 69, 104-106  
   *division, 110-112*  
   *moving, 110-112*  
   *multiplication, 110-112*

**Boolean operations (sign-extended), 479**

**bound instruction, 462-465, 714**  
 interrupt handlers, 463

**BOUND286.ASM program module (listing 11.6), 464-465**

**BOXCHAR.ASM program module (listing 11.3), 444**

**break command, 248-249**

**bsf (Bit Scan Forward), 470, 714-715**

**bsr (Bit Scan Reverse), 470, 715**

**bswap (Byte Swap) instruction, 715-716**

**bt (Bit Test) instruction, 716**

**btc (Bit Test and Complement) instruction, 716-717**

**btr (Bit Test and Reset) instruction, 717**

**bts (Bit Test and Set) instruction, 717-718**

**buffers**  
 ASYNCH.ASM (listing 10.4), 410-411  
 files, flushing, 340-341  
 memory input, 251  
 type-ahead, flushing, 255-256  
 video, 267

**BUFFERS = n command, 340**

**bugs, 8**  
*see also debugging*

**bytes, 54**  
 addresses, 55  
 converting to words, 472  
 gigabytes, 59  
 kilobytes (k), 59  
 megabytes, 59  
 number of bits, 55-56  
 signed values, converting to words, 100-101

## C

**C language**

assembly language  
   *calling C functions, 555-557*  
   *calling functions, 550-551*  
   *debugging, 554-555*  
   *global data, 564-565*  
 converting to assembly, 533  
 external functions, 532  
 function results, 557-558  
 inline statements, 532-538  
   *asm statements, 537*  
   *compiling, 535*  
   *microprocessors, 538*  
 listings, 820  
 registers, 533  
 structures (fields), 540-541

**C++ language**  
 arguments, passing to assembly language, 568-570  
 assembly language  
   *calling C++ functions, 560-565*  
   *classes, 570-578*  
 CPPFUNC.CPP (listing 13.6), 561  
 CPPLOOP.ASM (listing 13.7), 562  
 functions  
   *assembly language, 562-563*  
   *name-overloading, 560-562*  
   *results, 557-558*  
 listings, 820-821

**call instruction, 718**

**CALL...METHOD directive, 599**

**callback functions (subroutines), 664**

**calling**  
 functions  
   *assembly language, 549-551*  
   *assembly language from C++, 562-563*  
   *C from assembly, 555-557*  
   *C++ from assembly, 560-565*  
 interrupts, 388  
 subroutines (flow-control), 112-113  
 virtual methods, 612

- calls**  
 external functions, 511-512  
 Pascal  
   *external routines*, 498-499  
   *functions*, 509-510  
   *procedures*, 502-504  
 subroutines with DR.ASM program  
   module, 364  
   Windows functions, 673
- case-sensitivity (command-lines)**, 33-35
- cbw (Convert Byte to Word) instruction**, 719
- cdq (Convert Doubleword to Quadword)**, 719
- Central Processing Unit (CPU)**, 4-5, 7
- CFILL.ASM (listing 13.5)**, 550-551, 555
- CFILLSTR.C (listing 13.4)**, 549  
   CFILL.ASM (listing 13.5), 555  
   compiling, 549-550
- character strings**, 26
- characters**  
 I/O redirection, 264-298  
 macros  
   *keyboard availability*, 333  
   *strings*, 307-308
- CHARS.ASM (listing 7.3)**, 279-282
- ChToBase subroutine, BINASC.ASM (listing 6.3)**, 235-236
- class operands, segments (programs)**, 447
- classes**  
 ASMFILL.AS (listings 13.12), 576-577  
 assembly language, accessing objects, 576-578  
 C++ and assembly language, 570-578  
 CPPOOP.CPP (listing 13.11), 572-574  
 OOP, 587-652  
 TBuffer, 572  
 windows registration, 670-672
- clc (Clear Carry Flag) instruction**, 719-720
- cld (Clear Direction Flag) instruction**, 720
- clearing trap flag (tf)**, 415-419
- cli (Clear Interrupt Flag) instruction**, 720-721
- closing files**, 339-341
- closing line**, 30
- cmc (Complement Carry Flag) instruction**, 721
- cmp (subtraction operator)**, 97
- cmp (Compare) instruction**, 721-722
- cmps (Compare String) instruction**, 722-723
- cmpxchg (Compare and Exchange) instruction**, 723
- code, sharing inline statements (C)**, 541-542
- CODE directive (linker definition files)**, 678
- code segments, 27-29, 503**  
 addresses, 508-509  
 overrides, 508  
 text lines (columns), 27  
 variables (exCode variable), 27
- CODESEG directive**, 28
- cold boots (system startup)**, 457-458
- COLDBOOT.ASM program module (listing 11.5)**, 457-458
- columns (text lines)**  
 aligning, 27  
 comments columns, 29-35  
 mnemonic column, 28-29  
 operands columns, 28-29
- .COM programs**  
 assembling, 45  
 writing, 42, 44
- combinations (logic instructions)**, 102-103
- combine operand**, 447
- COMM directive**, 439
- command line (DOS)**  
 parameters  
   *extracting*, 346, 351-352  
   *strings*, 351  
 reading, 346-354
- command tails**, 346
- command-lines**  
 case-sensitivity, 33-35

parameters, 346, 351-352  
     *reading*, 346-354  
     *options*, 33-34  
     *reading*, 346-354

**commands**

%NOLIST, 331, 333  
 adding to dialog boxes, 698  
 BUFFERS = n, 340  
 CPU window, 40-44  
 directives, 798-815  
     ARG, 516-517, 601  
     ASSUME, 451-452, 502, 509  
     CALL...METHOD, 599  
     CODESEG *directive*, 28  
     COMM, 439  
     COMMENT *directive*, 29  
     *conditional compilation*, 314-324  
     DATASEG, 665  
     DATASEG *directive*, 25-27  
     *db*, 152-155, 425  
     DB (*define byte*) *directive*, 25-26  
     *dt*, 425  
     *dw*, 152-155  
     DW (*define word*) *directive*, 25  
     ENDM, 320  
     ENDS, 450  
     EQU *directive*, 23-24  
     EXTRN, 353, 502-503, 564-567  
     FARDATA, 458-461  
     GLOBAL, 440  
     GOTO, 321  
     GROUP, 453  
     IDEAL *directive*, 20, 30  
     INCLUDE, 441  
     INCLUDELIB, 441-442  
     JUMPS, 130-131, 598  
     LABEL (*arrays*), 208-209  
     *linker definition files*, 677  
     LOCAL, 559  
     LOCALS, 598  
     *macros*, 323  
     *memory*, 154  
     MODEL, 21, 598  
     NOSMART, 478

OOP, 597  
 ORG (*origin*) *directive*, 44  
 P286, 462  
 P286N, 462  
 POPSTATE, 322  
 PUBLIC, 171-172  
 PUSHSTATE, 322-324  
 RADIX (*numeric values*), 204-205  
 RECORD, 214-216  
 SEGMENT, 447-451, 500  
 SMART, 478-481  
 STACK *directive*, 21, 385  
 STRUC, 590-602  
 TITLE *directive*, 49  
 UDATASEG, 156  
 UFARDATA, 461  
 UNION, 213  
 VERSION, 474-475  
 EXTRN DiskErr:Proc, 344  
 File menu (Exit), 695  
 Help menu (About), 695  
 instructions, 706-786  
     16-bit *code segments*, 483  
     286 *microprocessors*, 463  
     32-bit *code segments*, 483  
     386 *microprocessors*, 470-474  
     8086 *microprocessor*, 126-139  
     aaa, 426  
     aad, 427  
     aam, 427  
     aas, 426  
     addition, 92-93  
     bound, 462-465  
     daa, 428  
     das, 428  
     doubleword *shift*, 474  
     enter, 466-467, 482  
     FASTIMUL, 484-489  
     *hlt* (*interrupts*), 376-377  
     ins, 467  
     lea, 445, 478  
     leave, 466-467, 482  
     logic, 101-110  
     loop, 481

- mul*, 360
- optimizing with SMART directive*, 478-481
- outs*, 467
- packed BCD numbers*, 428-429
- popa*, 467
- protected-mode*, 705
- pusha*, 467
- rotate (386 microprocessors)*, 483
- scasb*, 353
- shift (386 microprocessors)*, 483
- statements vs. actions*, 6
- subtraction*, 93-94
- timing values*, 705-706
- unpacked BCD numbers*, 426-427
- xlat*, 443-446
- macros, 300
- View:Variables (Turbo Debugger), 307-309
- commas (,)**, macro parameters, 303
- COMMENT directive**, 29
- comments**, 29-35
  - columns (text lines), 27
  - macros, 301
- communal variables**, 439
- compact memory models**, 22
- comparing string instructions**, 138-139
- compiling**
  - CFILLSTR.C (listing 13.4), 549-551
  - inline statements (C), 535
  - listings, 823
  - TALLY.C (listing 13.1), 535-542
- COMSHELL.ASM program (listing 2.2)**, 42-43
- conditional assembly directives (macros)**, 300
- conditional compilation directives**, 314-324
  - ENDIF, 318
  - error handling, 319
  - IF, 318
  - IFDEF, 319
  - IFNDEF, 319
- symbols
  - assembling program source code*, 316-318
  - testing for definition*, 319
  - undefining*, 319
- WHILE, 321-322
- conditional jumps**, 120-124
  - displacement restrictions, 124-125
  - references, 736
  - Turbo Debugger, 125-126
- conditional set-condition references**, 773-774
- conditional symbols**
  - assembling program source code, 316-318
  - defining, 314-316
- CONFIG.SYS files**, **BUFFERS = n command**, 340
- configurations (Windows resources)**, 678-679
- constant expression operators**, 318
- constant values**
  - inserting in stacks, 480
  - typed addresses, 509
- constructors (OOP)**, 587-652
- control codes (I/O)**, 250
- conversion table (binary values)**, 56-59
- CONVERT.ASM (listing 6.5)**, 241-243
- converting**
  - 32-bit doublewords to 64-bit quadwords, 472
  - ASCII digits to/from unpacked BCD numbers, 427
  - ASCIIZtoStr procedure to assembly language, 524
  - binary values
    - to/from packed BCD numbers*, 428-429
    - to/from unpacked BCD numbers*, 426
  - bytes to words, 472
  - C to assembly language, 533
  - hexidecimal values to decimal values, 60-61
  - numeric values, 225-243

## CONVERTING

- packed BCD numbers
    - to ASCII strings*, 437
    - to/from binary values*, 428-429
    - to/from unpacked BCD numbers*, 437
  - Pascal to assembly language, 496-497, 520-526
  - signed values (bytes to words), 100-101
  - strings, 225-240
  - StrToASCII procedure
    - to assembly language*, 524
  - unpacked BCD numbers
    - to/from ASCII digits*, 427
    - to/from binary values*, 426
    - to/from packed BCD numbers*, 437
  - words to doublewords, 472
  - coordinates (cursors), 269-271
  - copying packed BCD numbers, 438
  - CPPARG.CPP. (listing 13.8), 566-569
  - CPPFUNC.CPP (listing 13.6), 561
  - CPPLOOP.AM (listing 13.7), 562
  - CPPLOOP.CPP (listing 13.11), 572-574
  - CPU window, 39-44
  - CreateWindow function, 672
  - critical code, 532-533
  - CSHELL.ASM (listing 13.3), 546-548
  - Ctrl+I key command, 643
  - Ctrl+M key command, 302
  - Ctrl+W key command, 643
  - cursors (coordinates), 269-271
  - customizing FILTER.ASM. (listing 7.1), 264-265
  - cwd (Convert Word to Doubleword) instruction, 724
  - cwde (Convert Word to Extended Doubleword), 724
- ## D
- 
- daa (Decimal Adjust After Addition), 428, 724-725
  - das (Decimal Adjust After Subtraction), 428, 725
  - data, writing to files, 340
  - DATA directive (linker definition files)**, 678
  - data files (reading/writing)**, 359-361
  - data segments**, 24
    - creating, 458-461
    - initialized variables, 25
    - registers (initializing), 668-669
    - uninitialized variables, 25
    - variables, 25-27
  - data sharing (assembly language/Pascal)**, 504-508
  - data transfer (mov command)**, 80-90
  - data types**
    - adding to assembly language, 307
    - enumerated, 475-478
  - DATASEG directive**, 25-27, 665
  - DB (define bytes) directive**, 25-26
  - db directives**, 152-155, 425
  - deallocating stack parameters**, 516-517
  - debugging**, 6-7
    - hard disks, 341-344
    - interrupts, 414
    - macros, 320-321
    - microprocessors, 37-38
    - multilanguage programs, 554-555
    - OOP, 585, 648
    - single-step mode, 414-421
      - SINGLE.ASM (listing 10.6)*, 416-421
      - trap flag (tf)*, 415-419
    - trap flag (tf), 414-421
      - clearing*, 415-419
      - setting*, 415-419
    - Turbo Debugger, 37-42
      - conditional jumps*, 125-126
      - mov (data transfer)*, 83-84
      - watch window*, 96-97
  - dec (Decrement) instruction**, 725-726
  - decimals**, 56
    - Binary-Coded Decimals (BCD), 206
    - CONVERT.ASM (listing 6.5), 241-243
    - converting, 240-243
    - hexidecimal, converting, 60-61

**declaring**

derived objects, 618-620  
 function arguments, 569-570  
 parameters, 519  
 segments (programs), 447-451, 455  
 structured variables, 198-199  
 symbols, 565  
 variables  
   *assembly language, 539-540*  
   *uninitialized, 156*

Windows functions (external), 664

**default handler (windows), 675****defaults (union fields), 215-216****defining**

communal variables, 439  
 conditional symbols, 314-316  
 macros, 301

**derived objects (OOP), 587-652**

declaring/implementing, 618-620

**DESCRIPTION directive (linker definition files), 677****destructors (OOP), 588-652****device context handle (HDC), 694****dialog boxes**

commands, adding, 698  
 Windows applications, 696-698

**DialogBox function, 698****direct memory-addressing, 146****directives, 798-815**

ARG, 516-517  
   *methods, 601*  
 ASSUME, 451-452, 502, 509  
 CALL...METHOD, 599  
 CODESEG directive, 28  
 COMM, 439  
 COMMENT directive, 29  
 conditional compilation, 314-324  
 DATASEG, 665  
 DATASEG directive, 25-27  
 db, 152-155, 425  
 DB (define byte) directive, 25-26  
 dt, 425  
 dw, 152-155  
 DW (define word) directive, 25

ENDM, 320

ENDS, 450

EQU directive, 23-24

EXTRN, 353, 502-503, 564-567

FARDATA, 458-461

GLOBAL, 440

GOTO, 321

GROUP, 453

IDEAL directive, 20, 30

INCLUDE, 441

INCLUDELIB, 441-442

JUMPS, 598

*8086 processor instructions, 130-131*

LABEL (arrays), 208-209

linker definition files, 677

LOCAL, 559, 598

macros, 323

memory, 154

MODEL, 598

MODEL directive, 21

NOSMART, 478

OOP, 597

ORG (origin) directive, 44

P286, 462

P286N, 462

POPSTATE, 322

PUBLIC, 171-172

PUSHSTATE, 322-324

RADIX (numeric values), 204-205

RECORD

*reading, 216*

*union fields, 214-215*

*writing, 216*

SEGMENT, 447-451, 500

SMART, 478-481

STACK (Interrupt Subroutines), 21, 385

STRUC, 590-602

TITLE directive, 49

UDATASEG, 156

UFARDATA, 461

UNION, 213

VERSION, 474-475

*see also commands*



**directories**

installation, 826-828  
 reading, 361-365

**Disk Transfer Address (DTA)**, 365

**DiskErr program module**, 344

**DISKERR.ASM program module (listing 9.1)**, 342-344

**disks**

erasing, flushing type-ahead buffers, 255-256  
 formatting, flushing type-ahead buffers, 255-256

**displacement restrictions (conditional jumps)**, 124-125

**DisplayError routine (listing 7.1)**, 264

**displaying**

arrays, 208  
 BCD values, 437  
 strings, 173-179

**div (Unsigned Divide) instruction**, 389, 726-727

**DIV286.ASM (listing 10.2)**, 391-393

**DIVFAULT.A (listing 10.3)**, 394

**divide-faults**

DIV286.ASM (listing 10.2), 391-393  
*testing*, 393-394  
 DIVFAULT.A (listing 10.3), 394  
 interrupts  
*handling*, 389-390  
*installing handlers*, 390-395  
*trapping*, 389

**division**

bits, shifting, 110-112  
 signed values, 100  
 unsigned values, 97-98

**DOS (Disk Operating System)**, 6

assembly languages, reloading, 45  
 asynchronous serial I/O, 397-414  
 command line, 346-354

Exec functions

*0040h*, 359  
*03Dh*, 339  
*03Eh*, 341  
*03Fh*, 359

*042h*, 360

*04Ch*, 339

*059h*, 342

*45h*, 340

filters, 258-265

functions

*break command*, 248-249

*input*, 248

*interrupts*, 388

*key presses*, 252-253

*unfiltered input*, 249-250

*unfiltered output*, 250

handles, 256-257

*FILTER.ASM (listing 7.1)*, 262-264

macro libraries, 324-333

**DOSMACS.ASM program (listing 8.1)**, 324-333

**double jumps**, 122

**double semicolons (;);**, macro

comments, 301

**doubleword (bytes)**, 55, 474

**DR.ASM program module (listing 9.5)**, 362-364

**dt directive**, 425

**DTA (Disk Transfer Address)**, 365

**dummy parameters**, *see* formal parameters

**DUP operator**, 153-155

**DW (define word) directive**, 25

**dword directives**, 152-155

**dynamic variables (procedures)**, 466

**E**

**ECHOSTR.ASM (listing 5.3)**, 179-181

**encapsulation (OOP)**, 588-602

**End of Interrupt (EOI)**, 384

**EndDialog function**, 698

**ENDIF conditional compilation directive**, 318

**ENDM directive (macros)**, 309, 320, 450

**enter instruction**, 466-467, 482, 727

**entering program listings**, 15-16

**enumerated data types**, 475-478

**EOI (End of Interrupt)**, 384

- EQU directive, 23-24**  
**equal sign (=), 24, 316**  
**equates**  
 asterisk (\*), 24  
 ASYNCH.ASM (listing 10.4), 410  
 equal sign (=), 24  
 predefined, 223-224  
 rules, 23-24  
 VERSION.ASM (listing 6.2), 224-225  
**equates (constant values), 23-24**  
**EQUIP.ASM (listing 6.4), 237-239**  
**erasing disks, flushing type-ahead buffers, 255-256**  
**errors**  
 arrays, 344  
 handling  
   *conditional compilation directives, 319*  
   *hard disks, 341-344*  
 open-file codes, 340  
 programs, 34-37  
 Undefined symbol, 333  
**esc instruction, 727-728**  
**exclamation point (!), macro string characters, 307**  
**Exclusive OR operator (XOR), 67-69**  
**exCode variable, 27**  
**.EXE programs, 42, 46**  
**executing macro instructions, 302**  
**EXESHELL.ASM program (listing 2.3), 43-44**  
**EXETYPE directive (linker definition files), 677**  
**Exit command (File menu), 695**  
**expanding macros, 302-307**  
**exponents, 58**  
**exporting**  
 modules, 181-182  
 procedures to Pascal, 502  
**EXPORTS directive (linker definition files), 678**  
**expressions, 152**  
 macros, 306  
 operators, 153  
 passing to macros, 306
- external assemblies**  
 CSHELL.ASM (listing 13.3), 546-548  
 simplified memory models, 545-547  
 Turbo Linker, 544-550  
**external functions, 563-564**  
 C language, 532  
 calling, 511-512  
 Pascal conversion, 498-499  
**external interrupts, 370**  
**external modules**  
 assembling, 551-553  
 linking, 551-553  
**external string functions, 517-520**  
**extracting**  
 command line parameters, 346, 351-352  
 MTA.LIB library file modules, 441  
**EXTRN directive, 353, 502-503, 564-567**  
**EXTRN DiskErr:Proc command, 344**
- F**
- F1 function key (help), 39**  
**F5 function key, 443**  
**F7 function key, 302, 443, 522**  
**F8 function key, 302**  
**F10 function key, 443**  
**far data segments**  
 creating, 458-461  
 optimizing, 479  
**FARDATA directive, 458-461**  
**farword (bytes), 55**  
**FASTIMUL instruction, 484-489**  
**FCBs (file-control blocks), 338**  
**FF.ASM program (listing 2.1), 31**  
**FF.EXE program, 31**  
**fields**  
 C structures, 540-541  
 structured variables, 202-203  
 structures, 198  
 unions, 213-220  
   *bit, 214*  
   *inserting into records, 218-220*  
   *isolating values, 217-218*  
   *MASK operator, 217*

*names*, 216-217  
*RECORD directive*, 214-216  
*setting defaults*, 215-216

**File menu commands (Exit)**, 695

**file pointers (positioning)**, 361

**file-control blocks (FCB)**, 338

**files**

attributes, 345  
 availability, 339  
 buffers, flushing, 340-341  
 closing, 339-341  
 creating, 345  
 data (reading/writing), 359-361  
 handles, 256-257, 338  
 I/O, 338, 360  
 inventory, 826-828  
 opening, 339-340  
 processing  
     *by character*, 358-359  
     *by records*, 360-361  
 text, 354-359

**filling memory (string instructions)**, 136-137

**FILLSTR.ASM program module (listing 12.4)**, 518

**FILLSTR.PAS program (listing 12.5)**, 518

**FILTER.ASM. (listing 7.1)**, 258-262

customizing, 264-265  
 DOS handles, 262-264  
 routines  
     *DisplayError*, 264  
     *ReadChar*, 263  
     *WriteChar*, 264

**filters**

DOS, 258-265  
 FILTER.ASM. (listing 7.1), 258-262  
 unfiltered input, 249-250  
 unfiltered output, 250

**finding**

index values, 442  
 values, 442

**flags**, 7

8086 processor instructions, 127  
 ISR (Interrupt Subroutines), 376

registers (8086), 79  
 trap flag (tf), 414-421  
     *clearing*, 415-419  
     *setting*, 415-419

**flat memory models**, 22

**FLIPFLAG (logical operations)**, 220

**floating-point numbers**, 205-206

**floppy disk drives**, 14-15

**flow-control**, 110-126

jumps

*conditional*, 120-124  
     *displacement restriction*, 124-125  
     *double*, 122  
     *Turbo Debugger*, 125-126  
     *unconditional*, 119-120

return instructions, 116

subroutines, 112-113

*intersegment*, 116

*intra-segment*, 116

*passing values*, 117-118

*pushes*, 118-119

unconditional transfers, 112

**flushing**

file buffers, 340-341

type-ahead buffers, 255-256

**formal parameters (macros)**, 302

**formatting disks, flushing type-ahead buffers**, 255-256

**FORTH language**, 5

**function keys**

F5, 443  
 F7, 302, 443, 522  
 F8, 302  
 F10, 443  
 reading, 254-255

**functions**

0040h, 359  
 03Dh, 339  
 03Eh, 341  
 03Fh, 359  
 042h, 360  
 04Ch, 339  
 059h, 342  
 45h, 340

arguments  
     *declaring automatically*, 569-570  
     *passing*, 565-570

assembly language  
     *\_ASMFillBuffer*, 576  
     *calling*, 549  
     *calling C functions*, 555-557  
     *calling C++ functions*, 560-565  
     *calling from C*, 550-551  
     *calling from C++*, 562-563

C language results, 557-558

C++ language, name-overloading,  
 560-562

CreateWindow, 672

DialogBox, 698

DOS  
     *break command*, 248-249  
     *input*, 248  
     *interrupts*, 388  
     *key presses*, 252-253  
     *unfiltered input*, 249-250  
     *unfiltered output*, 250

EndDialog, 698

external, 563-564  
     *calling*, 511-512

external (Pascal conversion), 498-499

external string, 517-520

GDI, 694

InLine (Pascal conversion), 497

Pascal, 509-510

pointers (passing), 512

Print Screen, 383

procedures, 503

variables, 558-559

Windows  
     *calling*, 673  
     *declaring external*, 664

WinMain, 666, 669

---

**G**

---

**GDI (Graphics Device Interface)**, 694

**general-purpose registers (8086)**, 77  
     removing from stacks, 467

**GetCh procedure (listing 7.4)**, 293-295

**GETFIELD (logical operations)**, 221-231

**GetOneParam procedure**, 351-353

**GetParams procedure**, 351-352

**gigabytes**, 59

**global data (C/assembly language)**,  
 564-565

**GLOBAL directive**, 440

**global labels**, 304

**global variables**, 440-441  
     returning values, 353

**GOTO directive (macros)**, 321

**GPFs (general protection faults)**, 668

**GROUP directive**, 452-453

**grouping segments (programs)**, 453

---

**H**

---

**handlers, interrupt divide-faults**, 389-395

**handles**  
     DOS, FILTER.ASM. (listing 7.1),  
     262-264  
     files, 256-257, 338  
     *closing*, 341

**hard drives**  
     debugging, 341-344  
     directories, 361-365  
     files, 338  
     organizing, 13-14

**HARDSHEL.ASM program module**  
 (listing 11.4), 455-456

**hardware**  
     assembly language requirements, 9-10  
     floppy disk drives, 14-15  
     hard drives, 13-14  
     macros as device drivers, 300

**HDC (device context handle)**, 694

**headers, 20-22**

- IDEAL directive, 20
- MODEL directive, 21
- STACK directive, 21

**HEAPSIZE directive (linker definition files), 678****help, 16, 39****Help menu commands, 695****hexadecimal values, 56-59**

- CONVERT.ASM (listing 6.5), 241-243
- converting, 240-243
  - to decimal values, 60-61*
- defaults, 204-206
- RADIX directive, 204-205

**HexDigit subroutine (listing 6.3), 232****hlt (Halt) instruction, 728**

- interrupts, 376-377

**huge memory models, 22****I****I/O (Input/Output)**

- asynchronous serial, 397-414
- control codes, 250
- DOS functions, 248
- files, 338, 360
- function keys, 254-255
- redirection characters
  - <, 264-298
  - >, 264-298
  - |, 264-298
- ROM BIOS I/O routines, 253

**IDEAL directive, 20, 30****Ideal mode (TASM), 654**

- attributes, 7
- fields (structured variables), 203
- MASM mode equivalents, 795-797

**idiv (Signed Integer Divide) instruction, 100, 728****IF conditional compilation directive, 318****IFDEF conditional compilation directive, 319****IFNDEF conditional compilation directive, 319****importing modules, 181-182****imul (Signed Integer Multiply) instruction, 100, 729-730****in (Input From Port) instruction, 730-731****inc (Increment) instruction, 731****INCLUDE directive, 312, 441****INCLUDELIB directive, 441-442****increasing file availability, 339****index registers**

- 8086, 77-78
- string instructions, 132-133

**index values**

- finding, 442
- translating to table bytes, 443

**indexed memory-addressing, 149****indexing**

- arrays, 209-211
- bound instruction, 462-465
- range-checking errors, 463

**inheritance****OOP, 588-652**

- multiple, 588-652*
- objects, 602-626*
- single, 589-652*

**oop\inherit\TBASE.INC (listing 14.3), 603-604****oop\inherit\TDERIVED.INC (listing 14.4), 604-605****oop\inherit\INHERIT.ASM (listing 14.5), 607-608****INIT.ASM program module, 441****initialized variables, 25, 155-157****initializing**

- data segment registers, 668-669
- segments (programs), 450

**InLine functions/procedures (Pascal conversion), 497****inline statements (C), 532, 533-538**

- asm statements (access to C variables), 537-544

**assembly language, sharing code, 541-542****compiling, 535****microprocessors, 538**

- Pascal conversion, 496
- TALLY.C (listing 13.1), 535-542
- input, 248-257**
  - break command, 248-249
  - DOS functions, 248
  - filters (DOS), 258-265
  - function keys, 254-255
  - interrupts, 248-249
  - key presses, 252-253
  - memory buffers, 251
  - polling, 251
  - ROM BIOS I/O routines, 253
  - type-ahead buffers, flushing, 255-256
  - unfiltered, 249-250
- ins (Input From Port To String)**
  - instruction, 467, 732**
- inserting**
  - constant values into stacks, 480-481
  - directives in macros, 323
  - macros in programs, 301
  - subroutines with macros, 310
- installation directory, 826-828**
- installing**
  - bound instruction (interrupt handlers), 463
  - interrupt divide-fault handlers, 390-395
  - TSRs (Terminate and Stay Resident), 395-397
- instances (OOP objects), 588**
- instruction pointer registers (8086), 79**
- instructions, 706-786**
  - 16-bit code segments, 483
  - 286 microprocessors, 463
  - 32-bit code segments, 483
  - 386 microprocessors, 470-474
  - 8086 microprocessor, 126-131
    - flags, 127*
    - JUMPS directive, 130-131*
    - nop, 128-130*
    - string, 131-139*
    - synchronization, 128*
  - 8086 processor (string), 131-139
  - aaa, 426
  - aad, 427
  - aam, 427
  - aas, 426
  - addition, 92-93
  - bound, 462-465
  - daa, 428
  - das, 428
  - doubleword shift, 474
  - enter, 466-467, 482
  - FASTIMUL, 484-489
  - hlt (interrupts), 376-377
  - ins, 467
  - lea, 445, 478
  - leave, 466-467, 482
  - logic, 101-110
  - loop, 481
  - mul, 360
  - optimizing with SMART directive, 478-481
  - outs, 467
  - packed BCD numbers, 428-429
  - popa, 467
  - protected-mode, 705
  - pusha, 467
  - rotate (386 microprocessors), 483
  - scasb, 353
  - shift (386 microprocessors), 483
  - subtraction, 93-94
  - timing values, 705-706
  - unpacked BCD numbers, 426-427
  - xlat, 443-446
- int (Call Interrupt Service Routine)**
  - instruction, 388, 732-733**
- integers**
  - absolute values, 61
  - signed, 61-64, 205
  - two's complement, 61-64
  - unsigned, 205
- internal interrupts, 370**
- interrupts, 370**
  - 32-bit code segments, 483
  - 8259 processor, 372-376
  - asynchronous serial I/O, 397-414
  - bound instruction (handlers), 463
  - break command, 248-249

---

## INTERRUPTS

---

debugging, 414  
div instruction, 389  
divide-faults  
    *handling, 389-390*  
    *installing handlers, 390-395*  
    *trapping, 389*  
DOS functions, 388  
EOI (End of Interrupt), 384  
external, 370  
hlt instruction, 376-377  
int instruction, 388  
internal, 370  
into instruction, 388  
ISRs (Interrupt Subroutines), 370-371  
keyboard, 256  
maskable (INTR), 371-372  
nonmaskable (NMI), 371-372  
numbers, 373  
PC timer, 380-383  
    *interrupting ISRs, 382-383*  
    *variables, 381-382*  
PICS (Programmable Interrupt Chips),  
    372-376  
polling, 370  
SLOWMO.AS (listing 10.1), 378-380  
stacks, 385-388  
variables, 381-382  
vectors, 375-376  
    *restoring, 381-411*  
**intersegment subroutines, 116**  
**into (Interrupt On Overflow) instruction,**  
    **388, 733**  
**INTR (maskable interrupts), 371-372**  
**intrasement subroutines, 116**  
**invd (Invalidate Cache) instruction, 734**  
**invlpg (Invalidate TLB Entry) instruction,**  
    **734**  
**iret (Interrupt Return) instruction,**  
    **734-735**  
**IRP directive (macros), 308**  
**IRPC directive (macros), 308**  
**ISRs (Interrupt Subroutines), 370**  
    flags, 376  
    interrupting, 382-383

reentrant, 382-383  
STACK directive, 385  
variables, 381-382  
writing, 370-371

---

## J

---

**j-condition (Jump Conditionally)**  
**instruction, 735-736**  
**jmp (Jump Unconditionally) instruction,**  
    **737**  
**jumps**  
    conditional, 120-124  
        *displacement restrictions, 124-125*  
        *Turbo Debugger, 125-126*  
    double, 122  
    nop instruction, reserving space, 129-130  
    unconditional, 119-120  
    *see also flow-control*  
**JUMPS directive, 598**  
    8086 processor instructions, 130-131

---

## K

---

**key commands**  
    Alt+V+C, 443  
    Ctrl+I, 643  
    Ctrl+W, 643  
    Ctrl+M, 302  
**key presses, 252-253**  
**keyboard**  
    interrupts, 256  
    KEYBOARD.ASM (listing 7.4), 289-290  
    KEYS.ASM (listing 7.5), 291-292  
    module, 289-295  
**KEYBOARD.ASM (listing 7.4), 289-290**  
    procedures  
        *GetCh, 293-295*  
        *KeyWaiting, 292*  
**KEYS.ASM (listing 7.5), 291-292**  
**KeyWaiting procedure (listing 7.4), 292**

**keywords**

macros, 301  
PURGE, 301

**kilobytes (k), 59**

**KOPY.ASM program module**  
(*listing 9.4*), 354-358

**L**

**label column (text lines), 27**

**LABEL directive (macros), 309**

arrays, 208-209

**labeling**

macros, 313-314

variables with macros, 304

**labels**

local, 159-160

string instructions, 135

variables, 26

**lahf (Load Flags Into ah Register),**  
737-738

**languages, 4-5**

assembly language

*advantages, 7-8*

*attributes, 4-7*

*code segments, 27-29*

*components, 20-30*

*data segments, 24-25*

*disadvantages, 8-9*

*essentials to understanding, 5-6*

*hardware requirements, 9-10*

*headers, 20-22*

*software requirements, 10*

**C language**

*assembly language, 550-551, 554-555,*  
*564-565*

*converting to assembly, 533*

*external functions, 532*

*function results, 557-558*

*inline statements, 532-538*

*listings, 820*

*registers, 533*

*structures (fields), 540-541*

**C++ language**

*arguments, passing to assembly language,*  
*568-570*

*assembly language, 560-565, 570-578*

*CPPFUNC.CPP (listing 13.6), 561*

*CPPLOOP.ASM (listing 13.7), 562*

*functions, 557-558, 562-563*

*listings, 820-821*

FORTH language, 5

machine code, 4-5

**large memory models, 22**

**lds (Load Pointer and ds) instruction, 738**

**lea (Load Effective Address) instruction,**  
445, 478, 738-739

**leave instruction, 466-467, 482, 739**

**les (Load Pointer and es) instruction, 740**

**lfs lgs (Load Pointer and fs, gs)**

**instruction, 740-741**

**library strings, 160-170**

**library routines, 9**

**LIFO stacks, 85**

**linkers**

definition files (Windows), 677-678

Turbo Linker, 32

*external assemblies, 544-550*

*stacks, 84*

**linking**

external modules, 551-553

modules (programming), 172-173

modules into programs, 179-182

object codes, 32

program modules to library files, 441-442

**list objects (OOP), 627, 633**

**listings**

2.1 FF.ASM program, 31

2.2 COMSHELL.ASM, 42-43

2.3 EXESHELL.ASM program, 43-44

2.4 PR132.ASM program, 47

4.1 MOV.ASM, 82-83

4.2 PUSHPOP.ASM, 87

4.3 ADDSUB.ASM, 94-95

4.4 MULDIV.ASM, 98

4.5 ANDORXOR.ASM, 102-103

4.6 SHIFT.ASM, 105-106



- 4.7 SUBDEMO.ASM, 113
- 5.1 STRINGS.ASM, 161-170
- 5.2 STRJO.ASM, 174-176
- 5.3 ECHOSTR.ASM, 179-180
- 6.1 STRUC.ASM, 199-200
- 6.2 VERSION.ASM, 224
- 6.3 BINASC.ASM, 225-231
- 6.4 EQUIP.ASM, 237-239
- 6.5 CONVERT.ASM, 241-243
- 7.1 FILTER.ASM., 258-262
- 7.2 SCREEN.ASM, 273-279
- 7.3 CHARS.ASM, 279-282
- 7.4 KEYBOARD.ASM, 289-290
- 7.5 KEYS.ASM, 291-292
- 8.1 DOSMACS.ASM program, 324-333
- 9.1 DISKERR.ASM program module, 342-344
- 9.2 PARAMS.ASM program module, 346-349
- 9.3 SHOWPARG.ASM program module, 350-351
- 9.4 KOPY.ASM program module, 354-358
- 9.5 DR.ASM program module, 362-364
- 10.1 SLOWMO.AS, 378-380
- 10.2 DIV286.ASM, 391-393
- 10.3 DIVFAULT.ASM, 394
- 10.4 ASYNCH.ASM, 398-404
- 10.5 TRM.ASM, 405-409
- 10.6 SINGLE.ASM, 416-419
- 11.1 BCD.ASM program module, 430-434
- 11.2 TABLE.ASM program module, 442-443
- 11.3 BOXCHAR.ASM program module, 444
- 11.4 HARDSHEL.ASM program module, 455-456
- 11.5 COLDBOOT.ASM program module, 457-458
- 11.6 BOUND286.ASM program module, 464-465
- 12.1 PASSHELL.ASM program module, 500
- 12.2 PASDEMO.ASM program module, 505-506
- 12.3 PASDEMO.PAS program module, 506-507
- 12.4 FILLSTR.ASM program module, 518
- 12.5 FILLSTR.PAS program, 518
- 12.6 STR.PAS program, 520-521
- 12.7 STR.ASM program module, 524-525
- 13.1 TALLY.C, 535
- 13.2 UPDOWN.C, 541-544
- 13.3 CSHELL.ASM, 546-548
- 13.4 CFILLSTR.C, 549
- 13.5 CFILL.ASM, 550-551
- 13.6 CPPFUNC.CPP, 561
- 13.7 CPPLOOP.ASM, 562
- 13.8 CPPARG.CPP., 566-569
- 13.9 ASMARG.AS, 566
- 13.10 ASMARG2.ASM, 569-570
- 13.11 CPPOOP.CPP, 572-574
- 13.12 ASMFILL.ASM, 576-577
- 14.1 oop\encaps\TPOINT.INC, 592-594
- 14.2 oop\encaps\ENCAPSUL.ASM, 596-597
- 14.3 oop\inherit\TBASE.INC., 603-604
- 14.4 oop\inherit\TDERIVED.INC, 604-605
- 14.5 oop\inhert\INHERIT.ASM, 607-608
- 14.6 oop\OOMACROS.INC, 613-614
- 14.7 oop\virtual\TBASE.INC program, 616-617
- 14.8 oop\virtual\TDERIVED.INC program, 619-620
- 14.9 oop\virtual\VIRTUAL.ASM, 622-623
- 14.10 oop\list\TITEM.INC, 627-628
- 14.11 oop\list\TLIST.INC, 629-631
- 14.12 oop\list\TINTOBJ.INC, 633-634
- 14.13 oop\list\TSTROBJ.INC, 636-637
- 14.14 oop\list\LIST.ASM, 638-642
- 15.1 WHELLO.ASM program module, 655-661

- 15.2 WHELLO.DEF program, 661
  - 15.3 WHELLO.RC program, 662
  - 15.4 WINAPP.ASM program module, 680-690
  - 15.5 WINAPP.DEF program, 690
  - 15.6 WINAPP.RC program, 700
  - 15.7 WINAPP.RH program, 691
  - 15.8 WINAPP.RI program, 691-692
  - assembly language, 818-819
  - C language, 820
  - C++ language, 820-821
  - compiling, 823
  - object-oriented programming, 821-822
  - Pascal, 819
  - printing, 46-48
  - Windows, 822-823
  - loading string instructions, 133-134**
  - LOCAL directive (macros), 313-314, 559**
  - local labels, 159-160**
  - local variables (functions), 558-559**
  - LOCALS directive, 598**
  - lock (Lock the Bus) instruction, 741**
  - lods (Load String) instruction, 133-134, 742**
  - lodsb (string mnemonics), 134**
  - lodsw (string mnemonics), 134**
  - logic instructions, 101-110**
    - AND operator (bits), 103-104
    - ANDORXOR.ASM (listing 4.5), 102-103
    - combinations, 102-103
    - shifting bits, 104-106
  - logical operations**
    - bit fields
      - GETFIELD*, 221-223
      - SETFIELD*, 221-223
    - efficiency, 220-223
  - logical operators, 65-69**
    - AND (masking), 65-66
    - OR, 66-67
    - XOR, 67-69
  - loop (Loop on cx) instruction, 743**
  - loop instruction, 481**
  - loope loopz (Loop on cx While Equal) instruction, 743-744**
  - loopne loopnz (Loop on cx While Not Equal), 744**
  - loops, STRINGS.ASM (listing 5.1), 187**
  - LSD (least significant digit), 55**
  - lss (Load Pointer and ss) instruction, 745**
- 
- M**
- 
- machine code, 4-5**
    - registers, 7
  - macros, 300**
    - characters, keyboard availability, 333
    - conditional assembly directives, 300
    - creating arrays, 307
    - debugging, 320-321
    - defining, 301
    - directives, 323
    - DOS libraries, 324-333
    - DOSMACS.ASM file, 332
    - ENDM directive, 309, 320
    - expanding, 302-307
    - expansions
      - specifying*, 321
      - transferring*, 321
    - expressions
      - evaluating*, 306
      - passing*, 306
    - GOTO directive, 321
    - INCLUDE directive, 312
    - inserting
      - in programs*, 301
      - subroutines*, 310
    - instructions
      - executing*, 302
      - global labels*, 304
    - IRP directive, 308
    - IRPC directive, 308
    - keywords, 301
    - LABEL directive, 309
    - LOCAL directive, 313-314
    - local labels, 313-314
    - naming, 300

- nesting, 311
- numeric parameters, 305-306
- parameters, 302-307
- POPSTATE directive, 322
- preserving registers, 311
- pros/cons, 300
- purging, 301-302
- PUSHSTATE directive, 322
- repeating, 308
- replacing, 301
- source code, 310-314
- storage, 300
- storing in text files, 312
- string characters, 307
- string parameters, 306-307
- symbolic parameters, 304-305
- terminating, 320-321
- variables, 307
- VMTSeg, 614
- writing procedures, 310
- MASK operator (union fields), 217**
- maskable interrupts (INTR), 371-372**
- MASKFLAG (logical operations), 220**
- masking (AND operator), 65-66**
- MASM mode, 7**
  - Ideal mode equivalents, 795-797
  - memory addressing, 150
  - text lines (comments columns), 29
- math operators, 90-101**
  - addition, 92-93
  - ADDSUB.ASM (listing 4.3), 94-95
  - division, unsigned values, 97-98, 100
  - MULDIV.ASM (listing 4.4), 98-99
  - multiplication
    - signed values, 100
    - unsigned values, 97-98
  - subtraction, 93-94
    - cmp, 97
    - neg, 97
  - Turbo Debugger (watch window), 96-97
- mathematical operations**
  - BCDs, 429-438
  - multiplication, 484-489
  - maximum values of bits, 58-59
  - medium memory models, 21
  - megabytes, 59
  - members (OOP objects), 588
  - memory**
    - addressing, 144-145
      - ASSUME directive, 150-151
      - base, 148-149
      - base-indexed, 149-150
      - direct, 146
      - indexed, 149
      - MASM mode, 150
      - modes, 145-151
      - overrides, 146-147
      - register-indirect, 147-148
    - BCD variables, 425
    - buffers (input), 251
    - directives, 154
    - DTA, 365
    - optimizing flushing file buffers, 340
    - Pascal model, 499-502
    - registers, 7
    - segmentation (8086 processor), 74
      - offsets, 76
      - optimizing, 454
      - paragraphs, 75-76
    - simplified models (external assemblies), 545-547
    - stacks, 85-86
      - balancing, 88-89
      - exchanging data, 89-90
      - pops, 85
      - pushes, 85
    - string instructions, 136-137
    - TPASCAL model, 515
    - TSRs (Terminate and Stay Resident), 395-397
  - memory models, 21-22**
  - memory-mapped video, 267-272**
    - buffers, 267
    - cursor coordinates, 269-271
    - modules, 272-289
    - snow, 270-271

- message loops (Windows), 669, 673-674**
- messages (windows), 693**
  - passing, 675
- methods**
  - ARG directive, 601
  - OOP, 588-652
    - optimizing, 652*
    - static methods, 589*
    - virtual, 589, 609-626*
- microprocessors**
  - 286, 461-468**
  - 8086 processor
    - instructions, 126-131*
    - memory segmentation, 74-76*
    - registers, 76-79*
    - string instructions, 131-139*
  - 8259 processor interrupts, 372-376
  - debugging, 37-38
  - inline statements (C), 538
  - instructions, 706-786
  - programming, 461
  - protected-mode instructions, 705
- Microsoft Windows, 11**
  - see also Windows*
- mnemonics**
  - instructions, 706-786
  - string instructions, 134
  - text lines, 27-29
- MODEL directive, 21, 598**
- modes (memory-addressing), 145-151**
  - ASSUME directive, 150-151
  - base, 148-149
  - base-indexed, 149-150
  - direct, 146
  - indexed, 149
  - overrides, 146-147
  - register-indirect, 147-148
- modules, 13**
  - assembling, 172-173
  - DiskErr, 344
  - ECHOSTR.ASM (listing 5.3), 179-181
  - exporting, 181-182
  - external
    - assembling, 551-553*
    - linking, 551-553*
  - importing, 181-182
  - keyboard, 289-295
  - linking, 172-173
  - memory-mapped video, 272-289
  - programming
    - linking, 179-182*
    - sharing code, 170-173*
  - see also program modules*
- mov (data transfer), 80-90, 745-746**
  - MOV.ASM (listing 4.1), 82-83
  - stacks, 89-90
  - string instructions, 136
  - Turbo Debugger, 83-84
- MOV.ASM (listing 4.1), 82-83**
- MoveLeft procedure, 183-185**
- MoveRight procedure, 183-185**
- moving**
  - bits (shifting), 110-112
  - string instructions, 136
- movs (Move String) instruction, 746-747**
- movsx (Move and Extend Sign) instruction, 747-748**
- movzx (Move and Extend Zero Sign) instruction, 748**
- MSD (most significant digit), 55**
- MTA.LIB library files, extracting modules, 441**
- mul (Unsigned Multiplication) instruction, 360, 749**
- MULDIV.ASM (listing 4.4), 98-99**
- multibyte arrays, addressing, 211-213**
- multiple characters strings, 27**
- multiple inheritance (OOP), 588**
- multiplication**
  - bits (shifting), 110-112
  - operators
    - signed values, 100*
    - unsigned values, 97-98*

## N

**NAME directive (linker definition files), 677**  
**name operand, 447**  
**name-overloading, C++ functions, 560-562**  
**naming**  
   fields (union), 216-217  
   macros, 300-302  
   conventions (Windows applications), 665  
**navigating records, 361**  
**neg (Two's Complement Negation) instruction, 97, 750**  
   two's complement, 64  
**negative binary values, 63**  
**nesting macros, 311**  
**NewLine procedure, 179**  
**NMI (nonmaskable interrupts), 371-372**  
**nonmaskable interrupts (NMI), 371-372**  
**nop (No Operation) instruction, 128-130, 750-751**  
**NOSMART directive, 478**  
**not (One's Complement Negation) instruction, 751**  
   two's complement, 64  
**numbers (BCD storage), 424**  
**numeric parameters (macros), 302, 305-306**  
**numeric values**  
   binary (RADIX directive), 204-206  
   Binary-Coded Decimals (BCD), 206  
   BINASC.ASM (listing 6.3), 225-231, 236-239  
   CONVERT.ASM (listing 6.5), 241-243  
   converting, 225-243  
   decimal (RADIX directive), 204-206  
   floating-point numbers, 205-206  
   hexadecimal (RADIX directive), 204-206  
   integers  
     *signed, 205*  
     *unsigned, 205*  
**NumToASCII subroutine (listing 6.3), 233-234**

## O

**object codes, 32-33**  
**object-oriented programming, see OOP**  
**objects**  
   class (accessing), 576-578  
   debugging, 585  
   OOP, 584, 588-589  
     *16-bit integers, 633*  
     *base, 587-652*  
     *derived, 587-652, 618*  
     *inheritance, 602-626*  
     *instances, 588-652*  
     *list, 627, 633*  
     *members, 588-652*  
     *polymorphism, 627-645*  
     *static methods, 589*  
     *string, 636*  
     *virtual methods, 589, 609-626, 650-652*  
     *VMT pointers, 649-652*  
   oop\encaps\ENCAPSUL.ASM (listing 14.2), 596-597  
   oop\encaps\TPOINT.INC (listing 14.1), 592-594  
   structures, 590-602  
   Turbo Assembler, 589-626  
     *encapsulation, 590-602*  
**offsets (memory segmentation), 76**  
**one's complement, 62**  
   neg instruction, 64  
   not instruction, 64  
**OOP (Object-Oriented Programming), 584-589**  
   classes, 587-652  
   constructors, 587-652  
   debugging, 585, 645-646  
   destructors, 588-652  
   directives, 597  
     *ARG, 601*  
     *CALL...METHOD, 599*  
     *JUMPS, 598*  
     *LOCALS, 598*  
     *MODEL, 598*

- encapsulation, 588-652
- inheritance
  - multiple*, 588-652
  - single*, 589-652
- methods, 588-652
  - optimizing*, 652
  - virtual*, 609-626, 650-652
- listings, 821-822
- objects, 584, 588-626
  - 16-bit integers*, 633
  - base*, 587-652
  - derived*, 587-652
  - encapsulation*, 590-602
  - inheritance*, 602-626
  - instances*, 588-652
  - list*, 627, 633
  - members*, 588-652
  - polymorphism*, 627-645
  - static methods*, 589
  - string*, 636
  - virtual methods*, 589
  - VMT pointers*, 649, 650-652
- polymorphism, 588
  - Turbo Assembler, 586-587
- oop\encaps\ENCAPSUL.ASM (listing 14.2), 596-597
- oop\encaps\TPOINT.INC (listing 14.1), 592-594
- oop\inherit\TBASE.INC (listing 14.3), 603-604
- oop\inherit\TDERIVED.INC (listing 14.4), 604-605
- oop\inhert\INHERIT.ASM (listing 14.5), 607-608
- oop\list\LIST.ASM (listing 14.14), 638-642
- oop\list\TINTOBJ.INC (listing 14.12), 633-634
- oop\list\TITEM.INC (listing 14.10), 627-628
- oop\list\TLIST.INC (listing 14.11), 629-631
- oop\list\TSTROBJ.INC (listing 14.13), 636-637
- oop\OOMCROS.INC (listing 14.6), 613-614
- oop\virtual\TBASE.INC program (listing 14.7), 616-617
- oop\virtual\TDERIVED.INC program (listing 14.8), 619-620
- oop\virtual\VIRTUAL.ASM (listing 14.9), 622-623
- open-file error codes, 340
- opening files, 339-340
- operand columns (text lines), 27
- operands
  - bound instruction, 462
  - columns (text lines), 28-29
- operations (logical instructions), 220-223
- operators, 152, 792-794
  - constant expressions, 318
  - DUP, 153-155
  - expressions, 153
  - logical, 65-69
    - AND, 65-66
    - OR, 66-67
    - XOR, 67-69
  - MASK (union fields), 217
  - math, 90-101
    - addition*, 92-93
    - division*, 97-98
    - multiplication*, 97-98
    - subtraction*, 93-94
  - SYMTYPE values, 795
  - TYPE values, 795
- optimizing
  - addresses, 478
  - far data segments, 479
  - instructions with SMART directive, 478-481
  - memory, flushing file buffers, 340
  - methods (OOP), 652
  - procedures (stacks), 466
- or (Logical OR) instruction, 752
- OR operator (bits), 66-67
- ORG (origin) directive, 44
- out (Output to Port) instruction, 753

**output, 248-257**

- printers, 265-267
  - control sequences, 267-298*
  - selecting features, 266-267*
- unfiltered, 250

**outs (Output From String to Port)**

- instruction, 753-754**
- outs instruction, 467**
- overlying variables, 456**
- overloading functions (C++), 560-562**
- overrides (memory-addressing), 146-147**

**P**

**P286 directive, 462**

**P286N directive, 462**

**packed BCD numbers, 425**

- converting
  - to ASCII strings, 437*
  - to/from ASCII digits, 437-438*
  - to/from binary values, 428-429*
  - to/from unpacked BCD numbers, 437*
- instructions, 428-429
- variable lengths, 434
- variables, 438

**PackedToUnpacked routine**

(**listing 11.1**), 437

**paragraphs (memory segmentation), 75-76**

**ParamCount procedure, 351**

**parameters**

- addresses, 516-517
- bytes, removing from stacks, 514
- declaring, 519
- macros, 302-307
- stacks
  - deallocating, 516-517*
  - fixed, 517*
- values (passing), 512-513
- variables (passing), 514-515

**PARAMS.ASM program module, 352-354**

**PARAMS.ASM program module**  
(**listing 9.2**), 346-349

**Pascal**

- code shells, 499-502
- converting to assembly language, 496-497, 520-526
- external routines, 498-499
- external string functions, 517-520
- functions, 509-510
- listings, 819
- memory model, 499-502
- procedures, 502-504
- sharing with assembly language, 504-508
- static variables, 501-502
- variables, 511

**PASDEMO.ASM program module**  
(**listing 12.2**), 505-506

**PASDEMO.PAS program module**  
(**listing 12.3**), 506-507

**PASHELL.ASM program module**  
(**listing 12.1**), 500

**passing**

- arguments to functions, 480
- function arguments, 565-570
- function pointers, 512
- value parameters, 512-513
- variable parameters, 514-515
- window messages, 675

**passing values (subroutines), 117-118**

**PC timer (interrupts), 380-383, 381**

- interrupting ISRs, 382-383
- variables, 381-382

**Pentium microprocessors**  
(**Turbo Debuggers**), 37-38

**percent sign (%), expression evaluate operator, 306**

**phantom segments, 456**

**PICS (Programmable Interrupt Chips), 372-376**

**pointer registers (8086), 77-78**

**pointers**

- functions (passing), 512
- interrupt vectors, 375-376

**polling**

- input, 251
- interrupts, 370

- polymorphism**
  - OO, 588, 627-645
  - virtual methods, 610
- pop (Pop from Stack) instruction, 754-755**
- pop-up menus (Windows applications), 693, 695**
- popa (Pop All General-Purpose Registers), 467, 755**
- popad (Pop All General-Purpose Doubleword Register) instruction, 756**
- popf (Pop Flags) instruction, 756**
- popfd (Pop Extended Flags) instruction, 757**
- pops (stacks), 85**
  - balancing, 88-89
- POPSTATE directive, 322**
- portability (assembly language), 8-9**
- ports (strings), 467**
- powers (exponents), 58**
- PR132.ASM program (listing 2.4), 47-49**
- predefined equates, 223-224**
- Print Screen function, 383**
- printers, 265-267**
  - control sequences, 267-298
  - selecting features, 266-267
- printing**
  - listings, 46-48
  - PR132.ASM program, 49
- procedures**
  - ASCHZtoStr, 520
  - dynamic variables, 466
  - exporting to Pascal, 502
  - external (Pascal conversion), 498-499
  - GetOneParam, 351-353
  - GetParams, 351, 352
  - InLine (Pascal conversion), 497
  - KEYBOARD.ASM (listing 7.4)
    - GetCh*, 293-295
    - KeyWaiting*, 292
  - NewLine, 179
  - ParamCount, 351
  - Pascal, 502-504
- SCREEN.ASM (listing 7.2)
  - ScBlink*, 287-288
  - ScBright*, 287-288
  - ScClrRect*, 286
  - ScDim*, 287-288
  - ScGetAttribute*, 288
  - ScGotoXY*, 283-284
  - Scinit*, 289
  - ScNoBlink*, 287-288
  - ScPokeChar*, 284-285
  - ScPokeStr*, 284-285
  - ScReadXY*, 283-284
  - ScSetAttribute*, 288
  - ScSetBack*, 286-287
  - ScSetFore*, 286-287
  - SetVidAddr*, 282-283
- stacks, optimizing, 466
- STRINGS.ASM (listing 5.1), 182-193
  - MoveLeft*, 183-185
  - MoveRight*, 183-185
  - StrCompare*, 188-189
  - StrConcat*, 191
  - StrCopy*, 191
  - StrDelete*, 189-190
  - StrInsert*, 190-191
  - StrLength*, 186
  - StrNull*, 185
  - StrPos*, 192
  - StrRemove*, 192-193
  - StrUpper*, 187-188
- StrRead, 177
- StrToASCHZ, 520
- StrWrite, 177-178
- vs. functions, 503
- windows, 675-677
- WinProc, 693
- writing with macros, 310
- processing**
  - files
    - by character*, 358-359
    - by records*, 360-361
  - object codes (linkers), 32
  - tables, 442-446



**processor instructions (8086), 126-131****processors**

286, 461-468

8086 processor

*flags, 127**instructions, 126-131**JUMPS directive, 130-131**memory segmentation, 74-76**registers, 76-79**nop, 128-130**string instructions, 131-139**synchronization, 128*

8259 processor interrupts, 372-376

debugging, 37-38

inline statements (C), 538

instructions, 706-786

programming, 461

protected-mode instructions, 705

**profilers**

programs, 495

Turbo Profiler, 532

**program listings (entering), 15-16****program modules**

BCD.ASM (listing 11.1), 430-434

BOUND286.ASM (listing 11.6),  
464-465

BOXCHAR.ASM (listing 11.3), 444

COLDBOOT.ASM (listing 11.5),  
457-458

communal variables, 439

DISKERR.ASM (listing 9.1), 342-344

DR.ASM (listing 9.5), 362-364

FILLSTR.ASM (listing 12.4), 518

global variables, 440, 440-441

HARDSHEL.ASM (listing 11.4),  
455-456

INIT.ASM, 441

KOPY.ASM (listing 9.4), 354-358

linking to library files, 441-442

oop\virtual\VIRTUAL.ASM  
(listing 14.9), 622-623

PARAMS.ASM (listing 9.2), 346-349

PASDEMO.ASM (listing 12.2), 505-506

PASDEMO.PAS (listing 12.3), 506-507

PASSHELL.ASM (listing 12.1), 500

SHOWPARM.ASM (listing 9.3),  
350-351

STR.ASM (listing 12.7), 524-525

TABLE.ASM (listing 11.2), 442-443

WHELLO.ASM (listing 15.1), 655-661

WINAPP.ASM (listing 15.4), 680-690

**Program Segment Prefix (PSP), 346****programming**

286 microprocessors, 461-468

386 microprocessors, 468-474

critical code, 532-533

modules, 170-173

processors, 461

Windows with TASM, 654-679

**programs**

16-bit code segments, 483

32-bit code segments

*instructions, 483**interrupts, 483*

assembler programs, 4-5

assembling, 30-32

bits, maximum values, 58-59

code segments, 503

*addresses, 508-509*

.COM programs

*assembling, 45**writing, 42-44*

COMSHELL.ASM (2.2), 42-43

conditional compilation directives,  
314-324

critical code, 495-496

data segments, 24-25

*creating, 458-461**registers, initializing, 668-669*

debuggers, 6-7

*Turbo Debugger, 37-42*

DOSMACS.ASM (listing 8.1), 324-333

errors, 34-37

.EXE programs, 42, 46

EXESHELL.ASM programs (listing 2.3),  
43-44

FF.ASM (2.1), 31

FF.EXE, 31

- file handle maximums, 339
- FILLSTR.PAS (listing 12.5), 518
- flow-control, 110-126
  - jumps*, 119-126
  - return instructions*, 116
  - subroutines*, 112-113, 116-119
  - unconditional transfers*, 112
- initialized data, 665
- linkers, Turbo Linker, 32
- macros, 300-301
- modules, linking, 179-182
- oop\list\LIST.ASM (listing 14.14), 638-642
- oop\list\TINTOBJ.INC (listing 14.12), 633-634
- oop\list\TITEM.INC (listing 14.10), 627-628
- oop\list\TLIST.INC (listing 14.11), 629-631
- oop\list\TSTROBJ.INC (listing 14.13), 636-637
- oop\virtual\TBASE.INC (listing 14.7), 616-617
- oop\virtual\TDERIVED.INC (listing 14.8), 619-620
- options/settings (saving), 322
- PR132.ASM program (listing 2.4), 47
- profilers, 495
- segment overrides, 452
  - xlat instruction*, 446
- segments, 450-451
  - access operand*, 447
  - addresses*, 452
  - align operand*, 447
  - At*, 456
  - class operand*, 447
  - combine operand*, 447
  - declaring*, 446-451, 455
  - grouping*, 453
  - name operand*, 447
  - optimizing memory*, 454
  - phantoms*, 456
  - registers*, 450
  - small memory model*, 454
  - stacks*, 450
- source code, assembling with conditional symbols, 316
- startup code, 666-668
- state values, restoring, 322
- step throughs, 522
- STR.PAS (listing 12.6), 520-521
- TSRs (Terminate and Stay Resident), 395-397
- Turbo Assembler
  - Ideal mode*, 7
  - MASM mode*, 7
  - versions*, 15
- uninitialized data, 665
- uninitialized far data segments, 461
- variables, overlaying, 456
- warnings, 35-37
- WHELLO.DEF (listing 15.2), 661
- WHELLO.RC (listing 15.3), 662
- WINAPP.DEF (listing 15.5), 700
- WINAPP.RC (listing 15.6), 700
- WINAPP.RH (listing 15.7), 691
- WINAPP.RI (listing 15.8), 691-692
- see also applications*
- protected-mode instructions, 705**
- PSP (Program Segment Prefix), 346**
- PUBLIC directive, 171-172**
- PURGE keyword, 301**
- purging macros, 301-302**
- push (Push Onto Stack) instruction, 757-758**
- pusha (Push All General-Purpose Registers), 467, 758-759**
- pushad (Push All General-Purpose Doubleword Registers) instruction, 759**
- pushes**
  - balancing, 88-89
  - subroutines, 118-119
  - stacks, 85
- pushf (Push Flags) instruction, 759-760**
- pushfd (Push Extended Flags) instruction, 760**
- PUSHPOP.ASM (listing 4.2), 87-88**
- PUSHSTATE directive, 322-324**

**Q**

quadword (bytes), 55  
 quotes, string variables, 158-171

**R**

**RADIX directive**, 204-205  
**range-checking errors (indexes)**, 463  
**rcl (Rotate Left Through Carry) instruction**, 760-761  
**rcr (Rotate Right Through Carry) instruction**, 761-762  
**ReadChar routine (listing 7.1)**, 263  
**reading**  
   data files, 359-361  
   directories, 361-365  
   DOS command line, 346-354  
   function keys, 254-255  
   port strings, 467  
   text files, 354-359  
**RECORD directive (union fields)**, 214-216  
**records**  
   fields (union), 218-220  
   navigating, 361  
   unions, 214-215  
**redirection characters (I/O)**, 264-298  
**reentrant ISRs (Interrupt Subroutines)**, 382-383  
**references (tables)**, 446  
**register-indirect memory-addressing**, 147-148  
**registers**, 533  
   8086 microprocessors, 76-79  
     *flags*, 79  
     *general-purpose*, 77  
     *index*, 77-78  
     *instruction pointer (ip)*, 79  
     *pointer*, 77-78  
     *segment*, 78  
   al values, 339  
   data segments (programs), 668-669

memory, 7  
*Turbo Debugger*, 38

preserving with macros, 311  
 removing from stacks, 467  
 segments (programs), 450  
 string instructions (index), 132-133

**registration (window classes)**, 670-672

**reloading DOS**, 45

**removing**

  general-purpose registers from stacks, 467  
   parameter bytes from stacks, 514  
   registers from stacks, 467

**rep (Repeat) instruction**, 762-763

**repe (Repeat While Equal) instruction**, 762-763

**repeating macros**, 308

**replacing macros**, 301

**repne (Repeat While Not Equal) instruction**, 764

**repz (Repeat While Zero) instruction**, 764

**resource script files (Windows)**, 678-679

**resources (Windows)**

  configuring, 678-679  
   identifying, 671

**restoring**

  programs, 322  
   vector interrupts, 381-411

**return instructions (flow-control)**, 116

**returning**

  addresses, 482  
   global variables, 353

**rol (Rotate Left) instruction**, 766

**ROM BIOS**

  I/O routines, 253  
   timer, 380

**ror (Rotate Right) instruction**, 767-768

**rotate instructions**, 483

**rotating**

  bits, 69  
   logic instructions, 101-110  
   values (286 programming), 468

**routines**

ASYNCH.ASM (listing 10.4), 409-414  
*AsynchIn*, 413  
*AsynchInit*, 411  
*AsynchInStat*, 413  
*AsynchISR*, 413-414  
*AsynchOut*, 413  
*AsynchStop*, 412  
 BCDDAdd (listing 11.1), 435-436  
 BCDCopy (listing 11.1), 438  
 BCDSUBtract (listing 11.1), 436  
 BCDDToASCII (listing 11.1), 437-438  
 external (Pascal), 498-499  
 FILTER.ASM. (listing 7.1)  
*DisplayError*, 264  
*ReadChar*, 263  
*WriteChar*, 264  
 PackedToUnpacked (listing 11.1), 437  
 UnPackedToPacked (listing 11.1), 437

**running**

ADDSUB.ASM (listing 4.3), 95  
 ANDORXOR.ASM (listing 4.5), 103  
 MULDIV.ASM (listing 4.4), 98-99  
 PUSHPOP.ASM (listing 4.2), 87-88  
 SHIFT.ASM (listing 4.6), 106-109  
 STRUC.ASM (listing 6.1), 200-202  
 SUBDEMO.AS (listing 4.7), 114-116  
 VERSION.ASM (listing 6.2), 224-225

**S**

**sahf (Store ah Register to Flags)**  
 instruction, 768  
**sal (Shift Arithmetic Left) instruction**,  
 768-769  
**sample rates (program profilers)**, 496  
**sar (Shift Arithmetic Right) instruction**,  
 769-770  
**saving**  
 assembly language, operating state, 323  
 programs, options/settings, 322  
**sbb (Subtract Integers with Borrow)**,  
 770-771

**SBinToAscDec subroutine (listing 6.3)**,  
 234-235

**scanning**

386 microprocessors, 470  
 string instructions, 137-138

**scas (Scan String) instruction**, 137-138,  
 771-772

**scasb instruction**, 353

**ScBlink procedure (listing 7.2)**, 287-288

**ScBright procedure (listing 7.2)**, 287-288

**ScClrRect procedure (listing 7.2)**, 286

**ScDim procedure (listing 7.2)**, 287-288

**ScGetAttribute procedure**  
 (listing 7.2), 288

**ScGotoXY procedure (listing 7.2)**,  
 283-284

**Scinit procedure (listing 7.2)**,  
 289-292

**ScNoBlink procedure (listing 7.2)**,  
 287-288

**ScPokeChar procedure (listing 7.2)**,  
 284-285

**ScPokeStr procedure (listing 7.2)**,  
 284-285

**ScReadXY procedure (listing 7.2)**,  
 283-284

**SCREEN.ASM (listing 7.2)**, 273-279  
 procedures, 282-291

*ScBlink*, 287-288

*ScBright*, 287-288

*ScClrRect*, 286

*ScDim*, 287-288

*ScGetAttribute*, 288

*ScGotoXY*, 283-284

*Scinit*, 289

*ScNoBlink*, 287-288

*ScPokeChar*, 284-285

*ScPokeStr*, 284-285

*ScReadXY*, 283-284

*ScSetAttribute*, 288

*ScSetBack*, 286-287

*ScSetFore*, 286-287

*SetVidAddr*, 282-283

- ScSetAttribute procedure (listing 7.2), 288**
- ScSetBack procedure (listing 7.2), 286-287**
- ScSetFore procedure (listing 7.2), 286-287**
- searching values, 442**
- SEGMENT directive, 447-451, 500**
  - access operand symbols, 449
  - align operand symbols, 448
  - combine operand symbols, 448-449
  - use operand symbols, 449
- segment registers (8086), 78**
- segments (programs), 450-451**
  - access operand, 447
  - addresses, 452
  - align operand, 447
  - At, 456
  - class operand, 447
  - combine operand, 447
  - declaring, 446-451, 455
  - grouping, 453
  - name operand, 447
  - optimizing memory, 454
  - phantoms, 456
  - registers, initializing, 450
  - small memory model, 454
  - stacks, 450
- serial communications**
  - ASYNCH.ASM (listing 10.4), 398-404
  - asynchronous serial I/O, 397-414
  - TRM.ASM (listing 10.5), 405-409
- set-condition instruction, 772-774**
- SETFIELD (logical operations), 221-231**
- SETFLAG (logical operations), 220**
- setting**
  - 386 microprocessors (bits), 470
  - trap flag (tf), 415-419
- SetVidAddr procedure (listing 7.2), 282-283**
- sharing**
  - code, inline statements (C), 541-542
  - programming modules, 170-173
    - assembling*, 172-173
    - linking*, 172-173
    - PUBLIC directives*, 171-172
- shift instructions (386 microprocessors), 483**
- SHIFT.ASM (listing 4.6), 105-109**
- shifting**
  - 32-bit registers, 474
  - bits, 69, 104-106
    - division*, 111-112
    - moving*, 109-110
    - multiplication*, 110-112
  - logic instructions, 101-110
  - SHIFT.ASM (listing 4.6), 105-109
  - values (286 programming), 468
- shl (Shift Left) instruction, 775-776**
- shld (Double-Precision Shift Left) instruction, 776**
- SHOWPASM.ASM program module (listing 9.3), 350-351**
- shr (Shift Right) instruction, 777**
- shrd (Double-Precision Shift Right) instruction, 778**
- sign-extended Boolean operations, 479**
- signed integers, 205**
  - two's complement, 61-64
- signed values**
  - converting bytes to words, 100-101
  - division, 100
  - multiplication, 100
- simplified memory models (external assemblies), 545-547**
- single inheritance (OOP), 589**
- single-step mode**
  - debugging, 414-421
    - trap flags (tf)*, 415-419
  - SINGLE.ASM (listing 10.6), 416-421
- SINGLE.ASM (listing 10.6), 416-421**
- SLOWMO.AS (listings 10.1), 378-380**
- small memory models, 21**
- SMART directive, 478-481**
- snow (memory-mapped video), 270-271**
- software, *see* programs**
- source code (programs)**
  - assembling with conditional symbols, 316
  - macros, 310-314

- space (variables), 152-155**
- STACK directive, 21**
  - ISRs (Interrupt Subroutines), 385
- stacks, 84**
  - balancing, 88-89
  - constant values, inserting, 480
  - exchanging data, 89-90
  - fixed parameters, 517
  - interrupts, 385-388
  - LIFO, 85
  - memory, 85-86
  - parameter bytes (removing), 514
  - parameters
    - deallocating, 516-517*
    - fixed, 517*
  - pops, 85
  - procedures, 466
  - pushes, 85
  - PUSHPOP.ASM (listing 4.2), 87-88
  - registers, removing, 467
  - segments (programs), 450
  - variables (addresses), 515
- STACKSIZE directive (linker definition files), 678**
- standard flags, 708**
- startup code, 666-668**
- statements**
  - actions, 6-7
  - assembly language, declaring variables, 539-540
- static methods (OOP), 589**
- static variables (Pascal), 501-502**
- stc (Set Carry Flag) instruction, 778**
- std (Set Direction Flag) instruction, 779**
- step throughs (programs), 522**
- sti (Set Interrupt-Enable Flag) instruction, 780**
- storage (macros), 300**
  - string instructions, 135
- storing**
  - BCDs, 436
  - macros in text files, 312
  - numbers in BCD form, 424
  - string characters in words vs. bytes, 308
- stos (Store String) instruction, 780**
- STR.ASM program module (listing 12.7), 524-525**
- STR.PAS program (listing 12.6), 520-521**
- StrCompare procedure, 188-189**
- StrConcat procedure, 191**
- StrCopy procedure, 191**
- StrDelete procedure, 189-190**
- string instructions, 131-139**
  - addressing labels, 135
  - comparing, 138-139
  - index registers, 132-133
  - loading, 133-134
  - memory, filling, 136-137
  - mnemonics, 134
  - moving, 136
  - scanning, 137-138
  - storing data, 135
  - zero, 138
- string objects (OOP), 636**
- string parameters (macros), 302, 306-307**
- string variables, 157-159**
  - apostrophes, 158-171
  - quotes, 158-171
- strings**
  - ASCII, 157-158
  - characters
    - storing in words vs. bytes, 308*
    - strings, 26*
  - command line parameters (locating/passing), 351
  - converting, 225-240
  - displaying, 173-179
  - library module, 160-170
  - multiple characters strings, 27
  - ports (reading/writing), 467
  - procedures
    - NewLine, 179*
    - StrRead, 177*
    - StrWrite, 177-178*
  - STRINGS.ASM (listing 5.1), 161-170
  - STRIO.ASM (listing 5.2), 175-176

**STRINGS.ASM (listing 5.1), 161-170**

- procedures, 182-193
  - MoveLeft*, 183-185
  - MoveRight*, 183-185
  - StrCompare*, 188-189
  - StrConcat*, 191
  - StrCopy*, 191
  - StrDelete*, 189-190
  - StrInsert*, 190-191
  - StrLength*, 186
  - StrNull*, 185
  - StrPos*, 192
  - StrRemove*, 192-193
  - StrUpper*, 187-188

repeated string operations, 187

**StrInsert procedure, 190-191**

**STRIO.ASM (listing 5.1), 203-204**

**STRIO.ASM (listing 5.2), 175-176, 180-181**

**StrLength procedure, 186**

**StrNull procedure, 185**

**StrPos procedure, 192**

**StrRead procedure, 177**

**StrRemove procedure, 192-193**

**StrToASCIIZ procedure, 520**

converting to assembly language, 524

**STRUC directive, 590-602**

**STRUC.ASM (listing 6.1), 199-202**

**structures, 198-204**

- C language
  - asm statement access*, 538-544
  - fields*, 540-541

fields, 198

objects, 590-602

STRUC.ASM (listing 6.1), 199-202

unions, 213-220

variables

*declaring*, 198-199

*fields*, 202-203

*STRIO.ASM (listing 5.1)*, 203-204

**StrUpper procedure, 187-188**

**StrWrite procedure, 177-178**

**STUB directive (linker definition files), 678**

**sub (Subtract) instruction, 781**

**SUBDEMO.AS (listing 4.7), 113-116**

**subroutines**

BINASC.ASM (listing 6.3), 231-237

*AscToBin*, 236-245

*AscToNum*, 235-236

*BinToAscBin*, 234-235

*BinToAscDec*, 234-235

*BinToAscHex*, 234-235

*ChToBase*, 235-236

*HexDigit*, 232

*NumToASCII*, 233-234

*SBinToAscDec*, 234-235

*ValCh*, 232-233

callback functions, 664

calling with DR.ASM program module, 364

flow-control, 112-113

*intersegment*, 116

*intrasegment*, 116

*passing values*, 117-118

*pushes*, 118-119

inserting with macros, 310

ISR (Interrupt Subroutines), 370

SUBDEMO.AS (listing 4.7), 113-116

tail recursion, 652

**substitute operator (&), 304**

**subtraction (math operators)**

binary, 64

cmp, 97

neg, 97

operators, 93-94

**symbolic parameters (macros), 302-305**

**symbols, 788-789**

conditional compilation directives

*assembling program source code*, 316-318

*defining*, 314-316

*testing for definition*, 319

*undefining*, 319

declaring, 565

enumerated data types, 477

SEGMENT directive

*access operand*, 449

*align operand*, 448

*combine operand*, 448-449  
*use operand*, 449  
 Turbo Assembler, 790-792  
 warnclass, 790  
**SYMTYPE values (operators)**, 795  
**synchronization, 8086 processor instructions**, 128  
**system startup, cold booting**, 457-458

## T

**TABLE.ASM program module (listing 11.2)**, 442-443  
**table references**, 446  
**tail recursion (subroutines)**, 652  
**TALLY.C (listing 13.1)**, 535-542  
**TASM**  
   creating Windows applications, 679-698  
   Ideal mode, 654  
   programming Windows, 654-679  
**TBuffer class**, 572  
**tchuge memory models**, 22  
**terminating macros**, 320-321  
**test (Test Bits) instruction**, 782  
**TESTFLAG (logical operations)**, 220  
**testing**  
   386 microprocessors (bits), 472  
   conditional symbols for definition, 319  
**text**  
   files (reading/writing), 354-359  
   printing, 265-267  
**text lines**  
   columns, 27  
     *aligning*, 27  
     *comments columns*, 29-35  
     *operands columns*, 28-29  
   mnemonic columns, 28-29  
**timer (PC)**  
   interrupts, 380-383  
     *variables*, 381-382  
**timing values (instructions)**, 705-706  
**tiny memory models**, 21  
**TITLE directive**, 49  
**TPASCAL memory model**, 22, 515  
**transferring macro expansions**, 321  
**translating**  
   ASCII characters, 443  
   index values to table bytes, 443  
   value arrays, 445  
**trap flag (tf)**, 414-421  
   clearing, 415-421  
   setting, 415-421  
**trapping interrupt divide-faults**, 389  
**TRM.ASM (listing 10.5)**, 405-409  
**TSRs (Terminate and Stay Resident)**, 395-397  
**Turbo Assembler**  
   closing line, 30  
   .COM programs, 45  
   command-lines, 33-34  
   directives  
     *CODESEG directive*, 28  
     *COMMENT directive*, 29  
     *DATASEG directive*, 25-27  
     *DB (define byte) directive*, 25  
     *DB (define bytes) directive*, 26  
     *DW (define word) directive*, 25  
     *EQU directive*, 23-24  
     *IDEAL directive*, 30  
     *ORG (origin) directive*, 44  
     *TITLE directive*, 49  
   .EXE programs, 46  
   objects, 589-626  
     *encapsulation*, 590-602  
   OOP, 586-587  
   programs (errors), 34-37  
   symbols (predefined), 790-792  
   versions, 15  
   version 1.0, 798-810  
     *version 2.0*, 811  
     *version 2.5*, 812  
     *version 3.0*, 812-814  
     *version 3.1*, 814  
     *version 3.2*, 815  
     *version 4.0*, 481-486  
**Turbo Debugger**, 6-7, 37-42  
   conditional jumps, 125-126  
   CPU window, 39-44



microprocessors, 37-38  
 mov (data transfer), 83-84  
 variable window (arrays), 208  
 View:Variables command, 307, 309  
 watch window, 96-97

**Turbo Linker, 32**

external assemblies, 544-550  
 stacks, 84

**Turbo Profiler, 532****two's complement, 61-63**

absolute values, 64  
 neg instruction, 64  
 not instruction, 64

**TYPE values (operators), 795****type-ahead buffers, flushing, 255-256****typed constants (addresses), 509****U****UDATASEG directive, 156****UFARDATA directive, 461****unconditional jumps, 119-120****unconditional transfers (flow-control), 112****Undefined symbol error, 333****undefining conditional symbols, 319****underscores (assembly language), 548****unfiltered**

input, 249-250  
 output, 250

**uninitialized**

far data segments, 461  
 variables, 25, 155-157

**UNION directive, 213****unions**

bit fields, 214  
*inserting into records, 218-220*  
*isolating values, 217-218*  
*MASK operator, 217*  
*names, 216-217*  
*RECORD directive, 214-216*  
*setting defaults, 215-216*  
 fields, 213-220

records, 214-215  
 structures, 213-220

**unpacked BCD numbers****converting**

*to/from ASCII digits, 427*  
*to/from binary values, 426*  
*to/from packed BCD numbers, 437*

instructions, 426-427

variable lengths, 434

**UnPackedToPacked routine**

(*listing 11.1*), 437

**unsigned integers, 205****unsigned values**

division, 97-98

multiplication, 97-98

**UPDOWN. C (*listing 13.2*), 541-544****V****ValCh subroutine (*listing 6.3*), 232-233****value parameters, passing, 512-513****values**

arrays (translating), 445

enumerated data types, 477

fields (union), isolating, 217-218

rotating (286 programming), 468

searching, 442

shifting (286 programming), 468

subroutines, 117-118

**variables, 25-27**

addresses, 26

*verifying, 446*

assembly language, declaring, 539-540

ASYNCH.ASM (*lising 10.4*), 410

C language, asm statement access,  
 538-544

communal, 439

directives

*db, 152-155*

*dw, 152-155*

exCode variable, 27

exporting, 181-182

far data segments, 459

- global, 440-441
    - returning values*, 353
  - importing, 181-182
  - initialization modules, 441
  - initialized, 25, 155-157
  - interrupts, 381-382
  - labeling with macros, 304
  - labels, 26
  - local functions, 558-559
  - macros, 307
  - overlying, 456
  - parameters, passing, 514-515
  - Pascal (addresses), 511
  - space, 152-155
  - stacks (addresses), 515
  - static (Pascal), 501-502
  - strings, 157-159
    - apostrophes*, 158-171
    - quotes*, 158-171
  - structures, 198-204
    - declaring*, 198-199
    - fields*, 202-203
    - STRIO.ASM (listing 5.1)*, 203-204
  - uninitialized, 25, 155-157
  - vectors (interrupts)**, 375-376
    - restoring, 381-411
  - verifying variable addresses**, 446
  - VERSION directive**, 474-475
  - VERSION.ASM (listing 6.2)**, 224-225
  - video**
    - buffers, 267
    - CHARS.ASM (listing 7.3), 279-282
    - memory-mapped, 267-272
      - cursor coordinates*, 269-271
      - modules*, 272-289
      - snow*, 270-271
    - SCREEN.ASM (listing 7.2), 273-279
      - procedures*, 282-290
  - View:Variables command (Turbo Debugger)**, 307-309
  - virtual method table (VMT)**, 589
    - virtual methods**
      - calling, 612
      - OOP, 589, 609-626, 650-652
      - oop\OOMCROS.INC (listings 14.6), 613-614
      - polymorphism, 610
    - VMT (virtual method table)**, 589
    - VMT object pointers (OOP)**, 649-652
    - VMTSeg macro**, 614
- 
- W**

---

    - wait (Wait Until Not Busy) instruction**, 783
    - warnclass symbols**, 790
    - warnings (programs)**, 35-37
    - watch window (Turbo Debugger)**, 96-97
    - wbinvd (Write Back and Invalidate Cache)**, 783
    - WHELLO.ASM program module (listing 15.1)**, 655-661
    - WHELLO.DEF program (listing 15.2)**, 661
    - WHELLO.RC program (listing 15.3)**, 662
    - WHILE conditional compilation directive**, 321-322
    - WINAPP.ASM program module (listing 15.4)**, 680-690
    - WINAPP.DEF program (listing 15.5)**, 700
    - WINAPP.RC program (listing 15.6)**, 700
    - WINAPP.RH program (listing 15.7)**, 691
    - WINAPP.RI program (listing 15.8)**, 691-692
    - Windows, 11**
      - application shell, 679-692
      - applications, 655-662
        - creating with TASM*, 679-698
        - dialog boxes*, 696-698
        - naming conventions*, 665
        - pop-up menus*, 693-695
      - CreateWindow function, 672
      - functions
        - calling*, 673
        - declaring external*, 664

linker definition files, 677-678  
listings, 822-823  
message loops, 669, 673-674  
programming with TASM, 654-679  
resource script files, 678-679  
resources  
    *configuring*, 678-679  
    *identifying*, 671

**windows**

classes (registration), 670-672  
creating, 672-673  
default handler, 675  
messages, 693  
    *passing*, 675  
procedures, 675-677

**WinMain function, 666, 669**

**WinProc procedure, 693**

**words**

bytes, 55  
converting to doublewords, 472  
signed values converting to bytes,  
100-101

**WriteChar routine (listing 7.1), 264**

**writing**

.COM programs, 42-44  
data to files, 340  
data files, 359-361  
DOS filters, 258-265  
.EXE programs, 42, 46  
external string functions, 517-520  
ISR (Interrupt Subroutines), 370-371  
port strings, 467  
procedures with macros, 310  
programs (Ideal mode), 7  
text files, 354-359

**X-Y-Z**

**xadd (Exchange and Add) instruction, 784-785**

**xchg (Exchange) instruction, 784-785**

**xlat (Translate From Table) instruction, 443-446, 785**

**XOR (Exclusive OR), 220-223, 786**  
    masking, 67-69

**zero (string instructions), 138**

**GET CONNECTED**  
to the ultimate source  
of computer information!

## *The MCP Forum on CompuServe*

Go online with the world's leading computer book publisher!  
Macmillan Computer Publishing offers everything  
you need for computer success!

### *Find the books that are right for you!*

A complete online catalog,  
plus sample chapters and tables of contents  
give you an in-depth look at all our books.  
The best way to shop or browse!

- Get fast answers and technical support for MCP books and software
- Join discussion groups on major computer subjects
- Interact with our expert authors via e-mail and conferences
- Download software from our immense library:
  - Source code from books
  - Demos of hot software
  - The best shareware and freeware
  - Graphics files

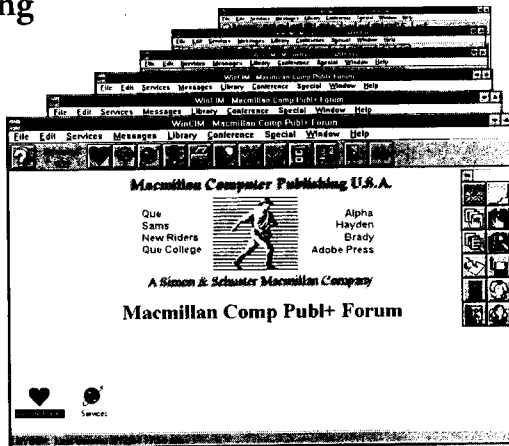

### **Join now and get a free CompuServe Starter Kit!**

To receive your free CompuServe Introductory Membership, call 1-800-848-8199 and ask for representative #597.

#### *The Starter Kit includes:*

- Personal ID number and password
- \$15 credit on the system
- Subscription to *CompuServe Magazine*